

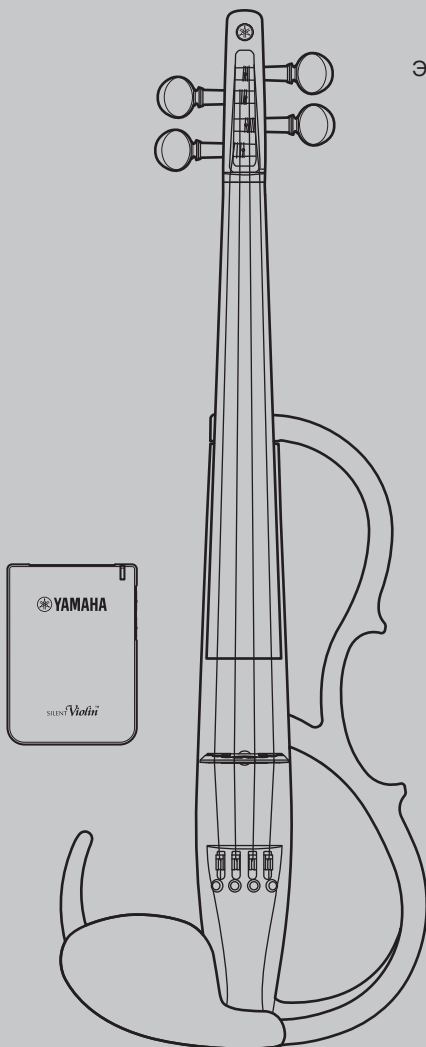

SILENT *Violin*TM

YSV104

Electric Violin
Электроскрипка
电小提琴



取扱説明書
Owner's Manual
Bedienungsanleitung
Mode d'emploi
Manuale di istruzioni
Manual de instrucciones
Manual do Proprietário
Руководство пользователя
使用说明书
사용 설명서

JA	EN	DE	FR	IT
ES	PT	RU	ZH	KO

日本語

English

Deutsch

Français

Italiano

Español

Português

Русский

中文

한국어

Thank you for purchasing a Yamaha SILENT Violin™.

The YSV104 is a new version of the SILENT Violin that incorporates Yamaha's exclusive SRT Powered system.

SRT Powered system simulates the natural sound and resonance of an acoustic violin by using samples that were recorded using high-quality microphones that were placed in the position of the player's ears. This gives players a natural playing experience through headphones, while its solid body design has reduced the actual sound output.

In order to obtain maximum performance and enjoyment from this instrument, we urge you to read this Owner's Manual thoroughly before using the instrument. We recommend that you keep it in a convenient place for future reference.

* "SILENT Violin™" and the SILENT *Violin*[™] logo are trademarks of the Yamaha Corporation.

* SRT: Studio Response Technology

Contents

PRECAUTIONS	3
Main Unit / Accessories	5
Parts Diagram: Main Unit.....	6
Parts Diagram: Control Box	8
Installing/Replacing batteries	10
About the Auto power off function	10
Tuning and Changing the Strings	11
The Shoulder Rest	13
Specifications	14

SPECIAL MESSAGE SECTION

This product should be used only with the components supplied or; a cart, rack, or stand that is recommended by Yamaha. If a cart, etc., is used, please observe all safety markings and instructions that accompany the accessory product.

SPECIFICATIONS SUBJECT TO CHANGE: The information contained in this manual is believed to be correct at the time of printing. However, Yamaha reserves the right to change or modify any of the specifications without notice or obligation to update existing units.

This product, either alone or in combination with an amplifier and headphones or speaker/s, may be capable of producing sound levels that could cause permanent hearing loss. DO NOT operate for long periods of time at a high volume level or at a level that is uncomfortable. If you experience any hearing loss or ringing in the ears, you should consult an audiologist.

IMPORTANT: The louder the sound, the shorter the time period before damage occurs.

NOTICE: Service charges incurred due to a lack of knowledge relating to how a function or effect works (when the unit is operating as designed) are not covered by the manufacturer's warranty, and are therefore the owners responsibility. Please study this manual carefully and consult your dealer before requesting service.

ENVIRONMENTAL ISSUES: Yamaha strives to produce products that are both user safe and environmentally friendly. We sincerely believe that our products and the production methods used to produce them, meet these goals. In keeping with both the letter and the spirit of the law, we want you to be aware of the following:

Disposal Notice: Should this product become damaged beyond repair, or for some reason its useful life is considered to be at an end, please observe all local, state, and federal regulations that relate to the disposal of products that contain lead, batteries, plastics, etc. If your dealer is unable to assist you, please contact Yamaha directly.

NAME PLATE LOCATION: The name plate is located on the bottom of the product. The model number, serial number, power requirements, etc., are located on this plate. You should record the model number, serial number, and the date of purchase in the spaces provided below and retain this manual as a permanent record of your purchase.

Model

Serial No.

Purchase Date

PLEASE KEEP THIS MANUAL

92-BP (bottom)

FCC INFORMATION (U.S.A.)

1. IMPORTANT NOTICE: DO NOT MODIFY THIS UNIT!

This product, when installed as indicated in the instructions contained in this manual, meets FCC requirements. Modifications not expressly approved by Yamaha may void your authority, granted by the FCC, to use the product.

2. IMPORTANT: When connecting this product to accessories and/or another product use only high quality shielded cables. Cable/s supplied with this product MUST be used. Follow all installation instructions. Failure to follow instructions could void your FCC authorization to use this product in the USA.

3. NOTE: This product has been tested and found to comply with the requirements listed in FCC Regulations, Part 15 for Class "B" digital devices. Compliance with these requirements provides a reasonable level of assurance that your use of this product in a residential environment will not result in harmful interference with other electronic devices. This equipment generates/uses radio frequencies and, if not installed and used according to the instructions found in the users manual, may cause interference harmful to the operation of other electronic devices. Compliance with FCC regulations does not guarantee that interference will not occur in all

installations. If this product is found to be the source of interference, which can be determined by turning the unit "OFF" and "ON", please try to eliminate the problem by using one of the following measures:

Relocate either this product or the device that is being affected by the interference.

Utilize power outlets that are on different branch (circuit breaker or fuse) circuits or install AC line filter/s.

In the case of radio or TV interference, relocate/reorient the antenna. If the antenna lead-in is 300 ohm ribbon lead, change the lead-in to co-axial type cable.

If these corrective measures do not produce satisfactory results, please contact the local retailer authorized to distribute this type of product. If you can not locate the appropriate retailer, please contact Yamaha Corporation of America, Electronic Service Division, 6600 Orangethorpe Ave, Buena Park, CA90620

The above statements apply ONLY to those products distributed by Yamaha Corporation of America or its subsidiaries.

(class B)

CAN ICES-3 (B)/NMB-3(B)

• This applies only to products distributed by Yamaha Canada Music Ltd.

• Ceci ne s'applique qu'aux produits distribués par Yamaha Canada Musique Ltée.

(can_b_01)

Information for users on collection and disposal of old equipment and used batteries:



These symbols on the products, packaging, and/or accompanying documents mean that used electrical and electronic products and batteries should not be mixed with general household waste.

For proper treatment, recovery and recycling of old products and used batteries, please take them to applicable collection points, in accordance with your national legislation.



By disposing of these products and batteries correctly, you will help to save valuable resources and prevent any potential negative effects on human health and the environment which could otherwise arise from inappropriate waste handling.



For more information about collection and recycling of old products and batteries, please contact your local municipality, your waste disposal service or the point of sale where you purchased the items.

For business users in the European Union:

If you wish to discard electrical and electronic equipment, please contact your dealer or supplier for further information.



Information on Disposal in other Countries outside the European Union:

These symbols are only valid in the European Union. If you wish to discard these items, please contact your local authorities or dealer and ask for the correct method of disposal.



Note for the battery symbol (bottom two symbol examples):

This symbol might be used in combination with a chemical symbol. In this case it complies with the requirement set by the EU Battery Directive for the chemical involved.

Cd

PRECAUTIONS

PLEASE READ CAREFULLY BEFORE PROCEEDING

Please keep this manual in a safe and handy place for future reference.



WARNING

Always follow the basic precautions listed below to avoid the possibility of serious injury or even death from electrical shock, short-circuiting, damages, fire or other hazards. These precautions include, but are not limited to, the following:

Do not open

- This instrument contains no user-serviceable parts. Do not open the instrument or attempt to disassemble or modify the internal components in any way.

Handling caution

- Take care not to pierce your finger with the end of the string. String ends are sharp and may cause injury.
- Never hold the instrument close to your face when adjusting or replacing strings. A string may unexpectedly break damaging your eyes.

Water warning

- Do not expose the instrument to rain, use it near water or in damp or wet conditions.

Battery

- Follow the precautions below. Failure to do so might result in explosion, fire, overheating or battery fluid leakage.
 - Do not tamper with or disassemble batteries.
 - Do not dispose of batteries in fire.
 - Do not attempt to recharge batteries that are not designed to be charged.
 - Use the specified battery type (page 14) only.
 - Keep the batteries separate from metallic objects such as necklaces, hairpins, coins, and keys.
 - Always make sure all batteries are inserted in conformity with the +/– polarity markings.

- When the batteries run out, or if the instrument is not to be used for a long time, remove the batteries from the instrument.
- Use new batteries, all of which are the same type, same model, and made by the same manufacturer.
- When using Ni-MH batteries, follow the instructions that came with the batteries. Use only the specified charger device when charging.
- Keep batteries away from small children who might accidentally swallow them.
- If the batteries do leak, avoid contact with the leaked fluid. If the battery fluid should come in contact with your eyes, mouth, or skin, wash immediately with water and consult a doctor. Battery fluid is corrosive and may possibly cause loss of sight or chemical burns.

If you notice any abnormality

- When one of the following problems occur, immediately turn off the power switch and remove all batteries from the instrument. Then have the device inspected by Yamaha service personnel.
 - It emits unusual smells or smoke.
 - Some object has been dropped into the instrument.
 - There is a sudden loss of sound during use of the instrument.

CAUTION

Always follow the basic precautions listed below to avoid the possibility of physical injury to you or others, or damage to the instrument or other property. These precautions include, but are not limited to, the following:

Connections

- Before connecting the instrument to other electronic components, turn off the power for all components. Before turning the power on or off for all components, set all volume levels to minimum.

Location

- Do not expose to direct sunlight (in a car during the day), high temperatures such as near a stove, or extremely low temperatures, and do not expose to vibrations or dust to prevent damage to the internal components or disfiguration.
- Do not place the instrument in an unstable position where it might accidentally fall over.
- Before moving the instrument, remove all connected cables, to prevent damage to the cables or injury to anyone who might trip over them.

Handling caution

- To prevent injury to others or property damage, do not swing or wave the bow when not playing, and never throw the bow.
- Do not use the instrument for a long period of time at a high or uncomfortable volume level, since this can cause permanent hearing loss. If you experience any hearing loss or ringing in the ears, consult a physician.
- If cleaning is required, wipe with a soft cloth. Do not use thinners, solvents, cleaning fluids, or wipes soaked with chemicals. Also, do not place vinyl or plastic products on the instrument. Doing so can cause discoloration/deterioration.
- Do not rest your weight on, or place heavy objects on the instrument, and do not use excessive force on the buttons, switches or connectors.
- To prevent injury to others or property damage, always maintain sufficient distance around you to prevent the bow from coming in contact with others and/or objects while playing the instrument.
- Make sure to discard used batteries according to local regulations.

Yamaha cannot be held responsible for damage caused by improper use or modifications to the instrument.

Main Unit / Accessories

After opening the packaging, please check that all the parts listed below are included.

- **Main unit × 1**

(The instrument is shipped from the factory with its bridge laying down.)

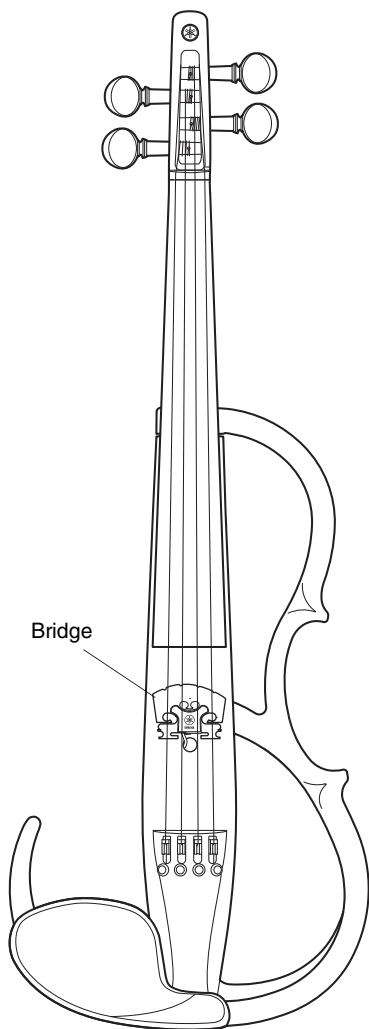

- **Control box × 1**

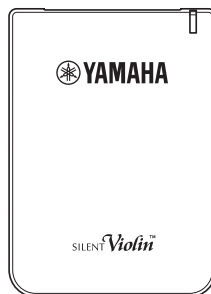

- **Cable × 2**

(Used to connect the instrument to the proprietary Control box. External audio devices can be connected via the Control box.)

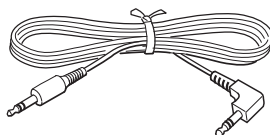

- **Stereo earphones × 1**

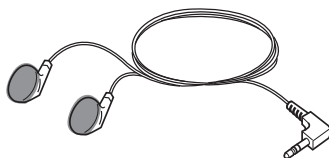

- **Owner's Manual (this booklet) × 1**

Parts Diagram: Main Unit

● Front

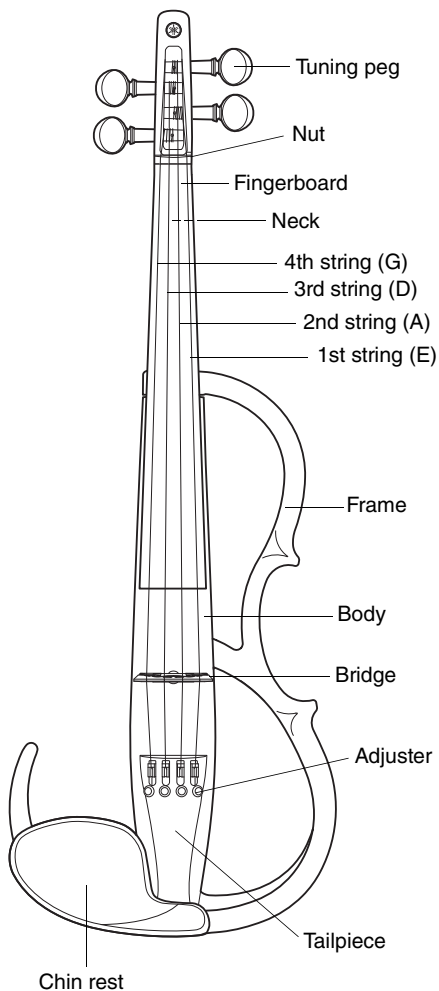

● Rear

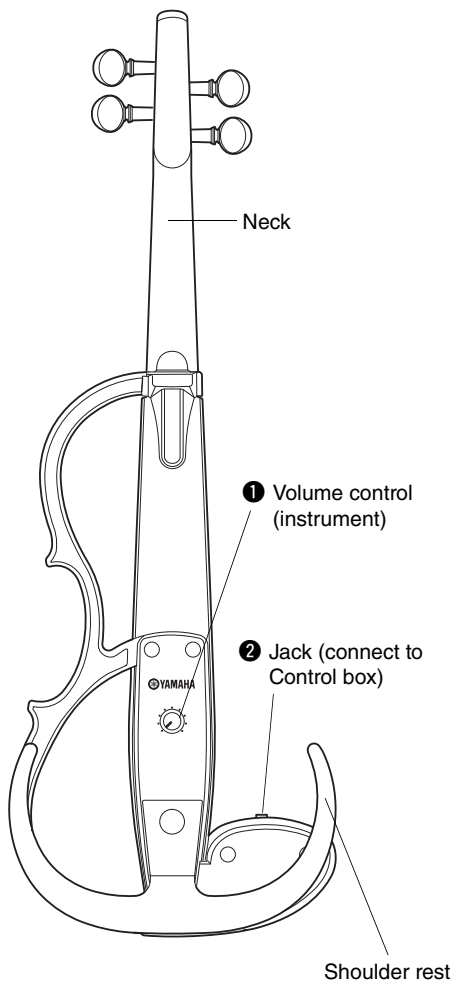

① Volume control (instrument)

Adjusts the instrument's output level volume to the proprietary Control box.

NOTE

- If the sound is distorted, rotate the Volume control dial to the left.

② Jack (connect to Control box)

This jack is used to receive power from the Control box and transmit the audio signal from the instrument to the Control box. Use the supplied cable to connect the instrument to the "Instrument jack" () on the Control box.

- * A commercially available audio cable with stereo mini plugs on both ends can also be used. (Cables with resistors are not compatible.)
- * The system will not operate properly if a monaural cable is used.
- * The system will not operate properly if the cable is attached to anything other than the Control box.

Connection example

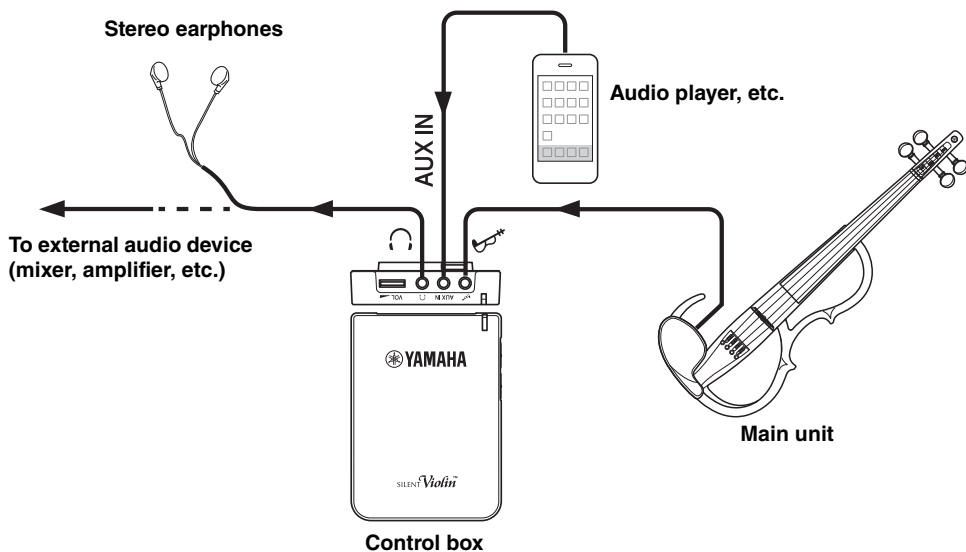

CAUTION

- Connect or disconnect the cable between the Silent Violin and the Control box only after the Control box power is switched OFF.
- When connecting the Silent Violin's Control box to an external device, make sure that the power is switched OFF on all devices, or that the volume on all devices is set to the minimum level. Loud volume levels can damage your hearing, and damage the equipment.
- When making connections to external devices, make sure that the proper plugs are used and securely connected.

Parts Diagram: Control Box

* For use with the YSV104. Not compatible with other instruments.

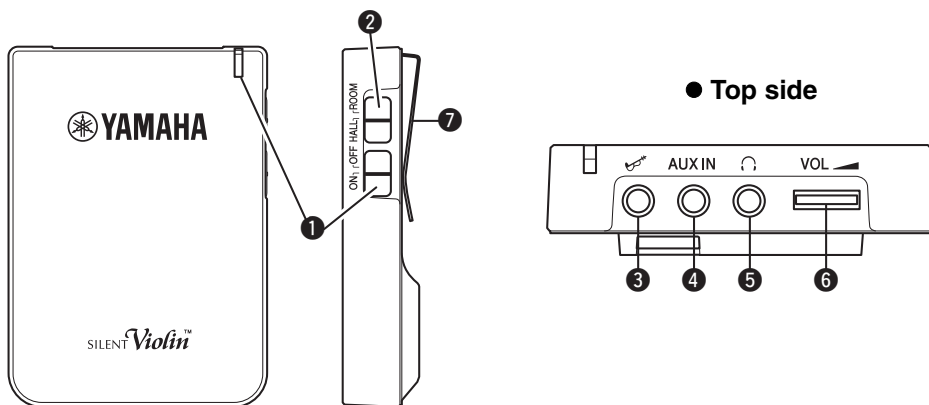

❶ Power switch (OFF/ON)/indicator

This is the unit's power switch. The "ON" position supplies the unit with power (indicator lights).

* Always make sure that the earphones or headphones are removed from your ears before switching the power ON or OFF.

❷ Sound type switch (ROOM/HALL)

Selects the type of sound.

ROOM: Ideal setting for practice. This effect offers a clear, distinct tone with a short reverb.

HALL: Ideal for performance. Provides a luxurious, ambience-rich with a soft tone and long reverb.

❸ Instrument jack ()

This jack is used to supply power to the Main unit and receive the audio signal from the instrument. Use the supplied cable to connect the Control box to the "Jack (connect to Control box)" on the instrument.

CAUTION

Never connect any devices (including other Silent Violins with different model numbers) other than the YSV104 Silent Violin that is included in the bundled set. Doing so may result in damage to the other device.

④ AUX IN jack (stereo mini phone jack)

Use the supplied cable (or a commercially available audio cable) to connect an external audio player or other such device to the AUX IN jack for playing along with audio from the external device.

* Use the volume control on the external audio device to control its volume.

⑤ PHONES jack (stereo mini phone jack)

For connecting a pair of stereo earphones or headphones to the unit. In order to take advantage of the SRT powered system, make sure the left and right sides of the inner earphones or headphones are properly positioned. Use the supplied cable (or a commercially available audio cable) to connect the unit to an external device for recording.

* Audio output is optimized for use with stereo earphones. When connecting other external devices we recommend using the left-channel signal from the stereo output, especially when recording. (When connecting the instrument's stereo output to the mono input on an external audio device, only the L channel signal is sent.)

* Do not connect the PHONES jack to a microphone jack (or mic/line jack) on a computer audio interface, mixer, etc., that supplies power to the connected device (plug-in-power, phantom power, etc.). Doing so may result in malfunction.

⑥ Volume control (VOL)

Controls the volume level of the “PHONES jack” ().

⑦ Clip

The clip is used to conveniently attach the Control box to your belt or pocket.

CAUTION

- Do not listen for extended periods of time at loud volume levels using the earphones or headphones. Doing so can result in damage to your hearing.
- If the sound is distorted, use the volume control on the Main unit or on the Control box and lower the volume until the sound is no longer distorted.
- Accidentally disconnecting the cable while the power is ON, or the unit experiencing a strong shock may cause a loud noise that can damage your hearing and the unit. Please use caution.

■ Installing/Replacing batteries

The device is powered by two AA alkaline or nickel-metal hydride* batteries.

* The device may not function properly due to the discharging characteristics of some nickel-metal hydride batteries.

⚠ CAUTION

Before replacing batteries, make sure that the power is switched “OFF”:

- 1 Remove the battery compartment cover on the back of the unit, and remove the old batteries.
- 2 Install the new batteries following the polarity markings in the illustration.
- 3 Replace the battery compartment cover.

* The indicator lights red when battery power is low. The unit automatically switches off when power is depleted. Please replace the batteries with a fresh set as soon as possible.

* For more information on battery use, please refer to the “PRECAUTIONS” section (page 3).

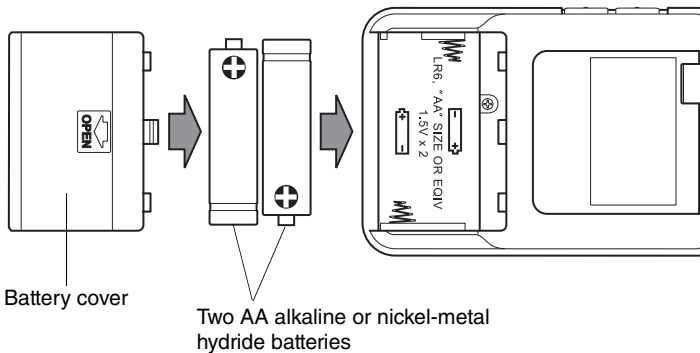

■ About the Auto power off function

In order to prevent unnecessary power consumption, the unit is equipped with an Auto power off function that automatically switches the power OFF if no signal is detected from the Instrument jack () for 30 minutes. If the power turns off because of this function, simply slide the power switch to the OFF position and then back to the ON position again (reboot).

Tuning and Changing the Strings

Because the bridge includes a built-in pickup, which is connected to the body with a thin cable, the instrument ships from the factory with the bridge laying down. First, set up the bridge and then proceed with tuning. As the strings get old, sound quality will gradually decrease, and it will become difficult to tune the instrument. Change the strings as soon as you think they are getting old.

WARNING

- The ends of the strings are sharp and can cut fingers. Use caution when changing strings.
- When changing or adjusting strings, do not put your face close to the instrument. The string may suddenly break resulting in eye or other unexpected injuries.

- The lower side of the bridge supports the 1st string (E), the higher side supports the 4th string (G). Please note the bridge orientation and center the bridge over the pickup cable hole as shown in the illustration below.

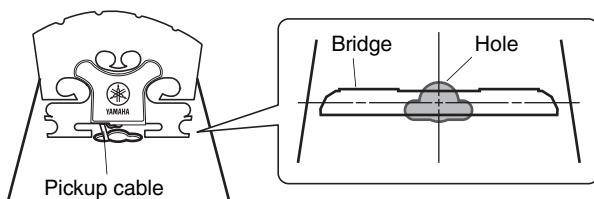
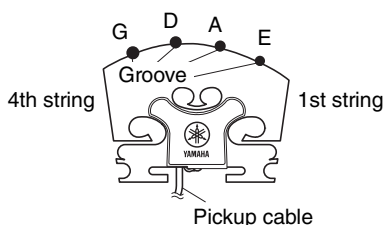

* The illustrations show the view looking from the tailpiece.

- Ensure that the bridge stands vertically. If it leans to one side, use both hands to adjust. Make sure that each string passes over the corresponding grooves in the bridge.

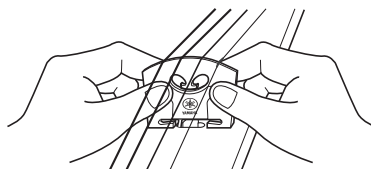
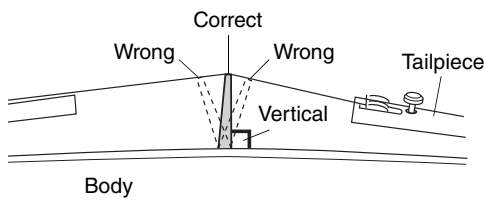

Place the bridge vertically.

⚠ CAUTION

Make sure that the strings are resting in their appropriate grooves in the bridge when playing the instrument.

Strings may come out of their grooves when adjusting the bridge or changing strings. Since the 1st (E) and 4th (G) strings tend to come out of their grooves more easily, use your fingers to hold those strings gently in place when tuning the instrument.

Also, the 1st (E) string is fitted with a protective tube. Make sure that the tube rests on the bridge.

Always make sure that the bridge is standing vertically, whether the instrument is being played or stored (see diagram on page 11).

Even if the bridge is standing vertically before tuning, it may tilt during the tuning process. If so, readjust the bridge so it stands vertically.

It is very important that the bridge stands vertically. If it leans in either direction, the sound may be impaired and damage may occur to the instrument.

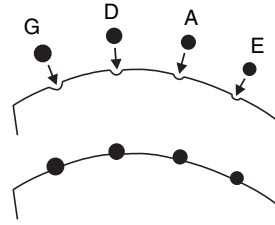

Make sure that the strings do not come out of their grooves.

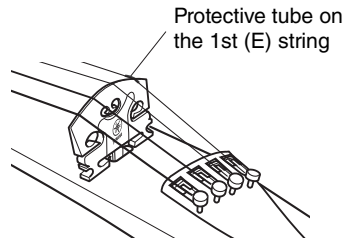

- String tunings are, 1st string E, 2nd string A, 3rd string D, 4th string G. Push in on the tuning peg and rotate to tune. Use a piano, tuning fork, or tuner as reference when tuning the instrument.
- Finally, use the adjuster to fine tune the strings.

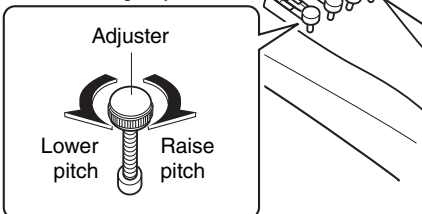
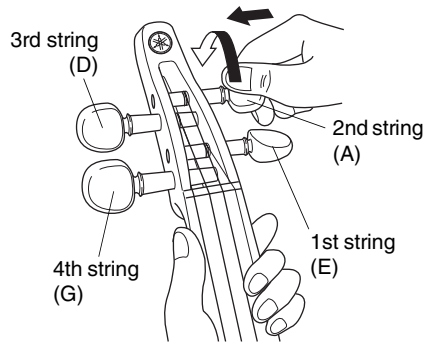

⚠ CAUTION

If the adjuster is too loose, it could produce noise while playing.



- When the instrument is not going to be used for an extended period of time, loosen the strings until the pitch drops a whole tone.
- Before using the instrument, make sure that the bridge is positioned vertically. Damage to the bridge and poor sound quality may result if the bridge is not properly positioned.

● Winding the strings

(Please refer to this section when changing the strings)

- 1 Before you string the instrument, set all adjusters so that they are in the middle of its adjustment range.
- 2 Place the ball (on the end of the string) in the notch on the adjuster, making sure the ball is properly inserted in the notch.

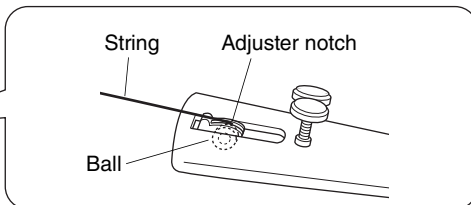
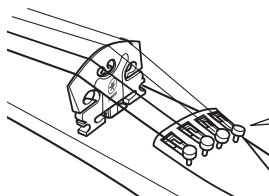
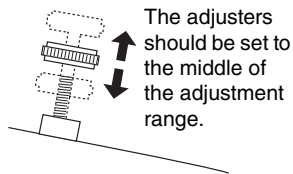

⚠ CAUTION

Do not use loop end E strings. It may damage the strings or fine tuner, and can cause injury.

- 3 After threading the string through the hole in the tuning peg, turn the tuning peg making one wrap on one side of the hole and the remaining wraps on the other side as shown in the diagram below.

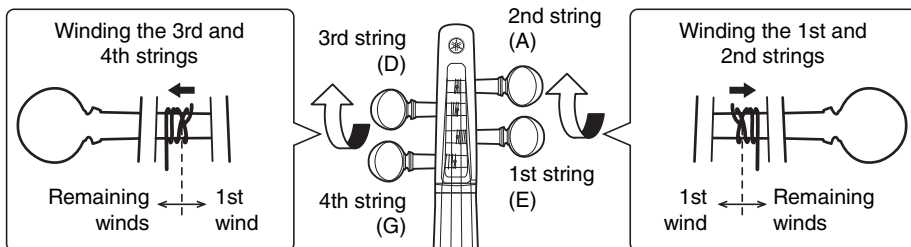

The Shoulder Rest

A commercially available violin shoulder rest (4/4 size) can be attached to the instrument.

* Some shoulder rests may not be compatible (air cushion type, etc.).

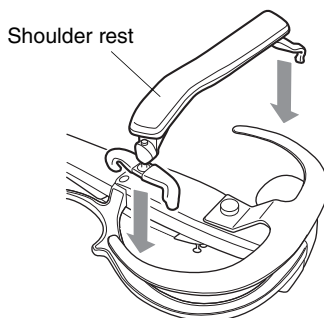

Specifications

● Main unit

Neck	Maple
Body	Spruce
Tuning pegs	Ebony
Bridge	Maple (with built-in pickup)
Frame	Synthetic resin
Tailpiece	Synthetic resin (equipped with adjusters)
Strings	Ball-end type violin strings (D'Addario Zyex)
Pickup	Bridge w/ built-in piezo-electric pickup
Power	Supplied via the Control box connection
String length	328 mm (12-15/16")
Dimensions	583 (L) × 206 (W) × 111 (H) mm 22-15/16" (L) × 8-1/8" (W) × 4-3/8" (H)
Weight	Approximately 490 g (1 lbs. 1 oz.)
Controls	Volume control

● Control box

Case	Synthetic resin
Connections	Instrument jack (Input/Output) AUX IN jack (Input) PHONES jack (Output) * All mini jack type
Controls	Volume control (VOL) Sound type switch (ROOM/HALL) Power switch (OFF/ON)
Power	SUM-3 (AA) alkaline or nickel-metal hydride batteries × 2 (3V DC)
Battery life	With Alkaline batteries: approximately 29 hours With Nickel-metal hydride batteries: approximately 24 hours * Depending upon usage and conditions
Dimensions	70 (W) × 20 (D) × 98 (H) mm 2-3/4" (W) × 3/16" (D) × 3-7/8" (H)
Weight	Approximately 70 g (2.5 oz.) without batteries

● Accessories

Cable × 2, stereo earphones × 1, Owner's Manual (this booklet) × 1

* The contents of this manual apply to the latest specifications as of the publishing date. To obtain the latest manual, access the Yamaha website then download the manual file.
Since specifications, equipment or separately sold accessories may not be the same in every locale, please check with your Yamaha dealer.

雅马哈乐器音响（中国）投资有限公司
上海市静安区新闻路1818号云和大厦2楼
客户服务热线：4000517700
公司网址：<http://www.yamaha.com.cn>

厂名：萧山雅马哈乐器有限公司
厂址：浙江省杭州市萧山经济技术开发区
红泰六路777号

YAMAHA CORPORATION

10-1 Nakazawa-cho, Naka-ku, Hamamatsu, 430-8650 Japan

Manual Development Group
© 2017 Yamaha Corporation

Published 09/2021 改版 MVD0
2021年9月发行

VFG2820 版次 R3