

GENERAL  
MIDI

XG

XF

DISK  
ORCHESTRASTYLE  
FILE

YAMAHA

# Clavinova®

**CVP-103**  
**CVP-103M**

## Owner's Manual

### IMPORTANT

#### Check Your Power Supply

Make sure that your local AC mains voltage matches the voltage specified on the name plate on the bottom panel. In some areas a voltage selector may be provided on the bottom panel of the main keyboard unit near the power cord. Make sure that the voltage selector is set for the voltage in your area. The voltage selector is set at 240V when the unit is initially shipped. To change the setting use a "minus" screwdriver to rotate the selector dial so that the correct voltage appears next to the pointer on the panel.

# SPECIAL MESSAGE SECTION

**PRODUCT SAFETY MARKINGS:** Yamaha electronic products may have either labels similar to the graphics shown below or molded/stamped facsimiles of these graphics on the enclosure. The explanation of these graphics appears on this page. Please observe all cautions indicated on this page and those indicated in the safety instruction section.

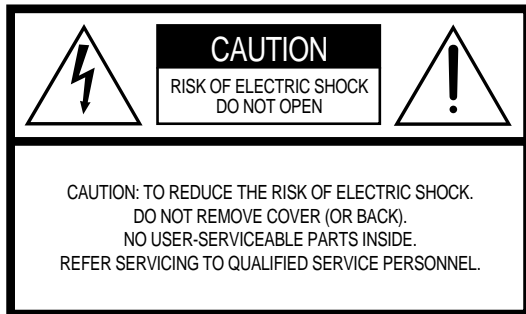

See bottom of Keyboard enclosure for graphic symbol markings.



The exclamation point within the equilateral triangle is intended to alert the user to the presence of important operating and maintenance (servicing) instructions in the literature accompanying the product.

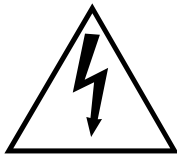

The lightning flash with arrowhead symbol, within the equilateral triangle, is intended to alert the user to the presence of uninsulated “dangerous voltage” within the product’s enclosure that may be of sufficient magnitude to constitute a risk of electrical shock.

**IMPORTANT NOTICE:** All Yamaha electronic products are tested and approved by an independent safety testing laboratory in order that you may be sure that when it is properly installed and used in its normal and customary manner, all foreseeable risks have been eliminated. DO NOT modify this unit or commission others to do so unless specifically authorized by Yamaha. Product performance and/or safety standards may be diminished. Claims filed under the expressed warranty may be denied if the unit is/has been modified. Implied warranties may also be affected.

**SPECIFICATIONS SUBJECT TO CHANGE:** The information contained in this manual is believed to be correct at the time of printing. However, Yamaha reserves the right to change or modify any of the specifications without notice or obligation to update existing units.

**ENVIRONMENTAL ISSUES:** Yamaha strives to produce products that are both user safe and environmentally friendly. We sincerely believe that our products and the production methods used to produce them, meet these goals. In keeping with both the letter and the spirit of the law, we want you to be aware of the following:

**Battery Notice:** This product MAY contain a small non-rechargeable battery which (if applicable) is soldered in place. The average life span of this type of battery is approximately five years. When replacement becomes necessary, contact a qualified service representative to perform the replacement.

**Warning:** Do not attempt to recharge, disassemble, or incinerate this type of battery. Keep all batteries away from children. Dispose of used batteries promptly and as regulated by applicable laws. Note: In some areas, the servicer is required by law to return the defective parts. However, you do have the option of having the servicer dispose of these parts for you.

**Disposal Notice:** Should this product become damaged beyond repair, or for some reason its useful life is considered to be at an end, please observe all local, state, and federal regulations that relate to the disposal of products that contain lead, batteries, plastics, etc.

**NOTICE:** Service charges incurred due to lack of knowledge relating to how a function or effect works (when the unit is operating as designed) are not covered by the manufacturer’s warranty, and are therefore the owners responsibility. Please study this manual carefully and consult your dealer before requesting service.

**NAME PLATE LOCATION:** The graphic below indicates the location of the name plate. The model number, serial number, power requirements, etc., are located on this plate. You should record the model number, serial number, and the date of purchase in the spaces provided below and retain this manual as a permanent record of your purchase.

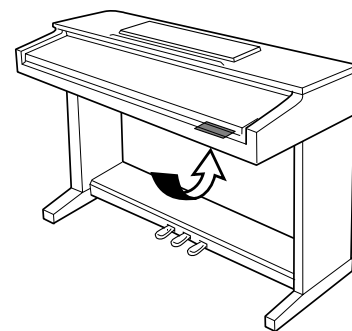

**Model** \_\_\_\_\_

**Serial No.** \_\_\_\_\_

**Purchase Date** \_\_\_\_\_

# PRECAUTIONS

## PLEASE READ CAREFULLY BEFORE PROCEEDING

\* Please keep these precautions in a safe place for future reference.



### WARNING

**Always follow the basic precautions listed below to avoid the possibility of serious injury or even death from electrical shock, short-circuiting, damages, fire or other hazards. These precautions include, but are not limited to, the following:**

- Do not open the instrument or attempt to disassemble the internal parts or modify them in any way. The instrument contains no user-serviceable parts. If it should appear to be malfunctioning, discontinue use immediately and have it inspected by qualified Yamaha service personnel.
- Do not expose the instrument to rain, use it near water or in damp or wet conditions, or place containers on it containing liquids which might spill into any openings.
- If the power cord or plug becomes frayed or damaged, or if there is a sudden loss of sound during use of the instrument, or if any unusual smells or smoke should appear to be caused by it, immediately turn off the power switch, disconnect the electric plug from the outlet, and have the instrument inspected by qualified Yamaha service personnel.
- Only use the voltage specified as correct for the instrument. The required voltage is printed on the name plate of the instrument.
- Before cleaning the instrument, always remove the electric plug from the outlet. Never insert or remove an electric plug with wet hands.
- Check the electric plug periodically and remove any dirt or dust which may have accumulated on it.



### CAUTION

**Always follow the basic precautions listed below to avoid the possibility of physical injury to you or others, or damage to the instrument or other property. These precautions include, but are not limited to, the following:**

- Do not place the power cord near heat sources such as heaters or radiators, and do not excessively bend or otherwise damage the cord, place heavy objects on it, or place it in a position where anyone could walk on, trip over, or roll anything over it.
- When removing the electric plug from the instrument or an outlet, always hold the plug itself and not the cord. Pulling by the cord can damage it.
- Do not connect the instrument to an electrical outlet using a multiple-connector. Doing so can result in lower sound quality, or possibly cause overheating in the outlet.
- Remove the electric plug from the outlet when the instrument is not to be used for extended periods of time, or during electrical storms.
- Before connecting the instrument to other electronic components, turn off the power for all components. Before turning the power on or off for all components, set all volume levels to minimum. Also, be sure to set the volumes of all components at their minimum levels and gradually raise the volume controls while playing the instrument to set the desired listening level.
- Do not expose the instrument to excessive dust or vibrations, or extreme cold or heat (such as in direct sunlight, near a heater, or in a car during the day) to prevent the possibility of panel disfiguration or damage to the internal components.
- Do not use the instrument near other electrical products such as televisions, radios, or speakers, since this might cause interference which can affect proper operation of the other products.
- Do not place the instrument in an unstable position where it might accidentally fall over.
- Before moving the instrument, remove all connected cables.
- When cleaning the instrument, use a soft, dry cloth. Do not use paint thinners, solvents, cleaning fluids, or chemical-impregnated wiping cloths. Also, do not place vinyl, plastic or rubber objects on the instrument, since this might discolor the panel or keyboard.
- Do not rest your weight on, or place heavy objects on the instrument, and do not use excessive force on the buttons, switches or connectors.
- If the instrument has a key cover, take care that the key cover does not pinch your fingers, and do not insert a finger or hand in the key cover gap.
- If the instrument has a key cover, never insert or drop paper or metallic or other objects between the slits of the key cover and the keyboard. If this happens, immediately turn off the power and remove the electric plug from the outlet and have the instrument inspected by qualified Yamaha service personnel.
- Do not place the instrument against a wall (allow at least 3 cm/one-inch from the wall), since this can cause inadequate air circulation, and possibly result in the instrument overheating.
- Read carefully the attached documentation explaining the assembly process. Failure to assemble the instrument in the proper sequence might result in damage to the instrument or even injury.
- Do not operate the instrument for a long period of time at a high or uncomfortable volume level, since this can cause permanent hearing loss. If you experience any hearing loss or ringing in the ears, consult a physician.

#### ■ USING THE BENCH (if included)

- Do not play carelessly with or stand on the bench. Using it as a tool or step-ladder or for any other purpose might result in accident or injury.
- Only one person should sit on the bench at a time, in order to prevent the possibility of accident or injury.
- If the bench screws become loose due to extensive long-term use, tighten them periodically using the included tool.

#### ■ SAVING USER DATA

- Always save data to a floppy disk frequently, in order to help prevent the loss of important data due to a malfunction or user operating error.

Yamaha cannot be held responsible for damage caused by improper use or modifications to the instrument, or data that is lost or destroyed.

Always turn the power off when the instrument is not in use.

Thank you for purchasing the Yamaha Clavinova! We recommend that you read this manual carefully so that you can fully take advantage of the advanced and convenient functions of the Clavinova. We also recommend that you keep this manual in a safe and handy place for future reference.

## Accessories

### ● Music Software Collection Disk (and Music Book)

This disk features sample songs that you can play back on your Clavinova, as well as MIDI driver software for computers.

### ● Floppy Disk

Use this blank disk to record your performances.

### ● Owner's Manual

This manual contains complete instructions for operating your Clavinova.

### ● Reference Booklet

This manual contains lists of voices, styles, and parameters, etc., as well as specifications and assembly instructions for your Clavinova.

### ● Bench

A bench may be included or optional, depending on your locale.

- The CVP-103M will be referred to as the CVP-103 in this Owner's Manual.
- The illustrations and LCD screens as shown in this owner's manual are for instructional purposes only, and may appear somewhat different from those on your instrument.
- Unauthorized copying of copyrighted software for purposes other than the purchaser's personal use is prohibited.

### ● Trademarks:

- Apple and Macintosh are trademarks of Apple Computer, Inc.
- IBM-PC/AT is a trademark of International Business Machines Corporation.
- Windows is the registered trademark of Microsoft® Corporation.
- All other trademarks are the property of their respective holders.

## The Panel Logos

The logos printed on the Clavinova panel indicate standards/formats it supports and special features it includes.



### GM System Level 1

"GM System Level 1" is an addition to the MIDI standard which guarantees that any data conforming to the standard will play accurately on any GM-compatible tone generator or synthesizer from any manufacturer.



### XG Format

XG is a new Yamaha MIDI specification which significantly expands and improves on the "GM System Level 1" standard with greater voice handling capacity, expressive control, and effect capability while retaining full compatibility with GM. By using the Clavinova's XG voices, it is possible to record XG-compatible song files.



### XF Format

The Yamaha XF format enhances the SMF (Standard MIDI File) standard with greater functionality and open-ended expandability for the future. The Clavinova is capable of displaying lyrics when an XF file containing lyric data is played. (SMF is the most common format used for MIDI sequence files. The Clavinova is compatible with SMF Formats 0 and 1, and records "song" data using SMF Format 0.)



### Disk Orchestra Collection

The DOC voice allocation format provides data playback compatibility with a wide range of Yamaha instruments and MIDI devices.



### Style File Format

The Style File Format (SFF) is Yamaha's original style file format, which uses a unique conversion system to provide high-quality automatic accompaniment based on a wide range of chord types. The Clavinova uses the SFF internally, reads optional SFF style disks, and creates SFF styles using the Custom Style feature.

# ..... Features of the Clavinova .....

## ● **Easy-to-use LCD Display**

The LCD (together with the various panel buttons) provides comprehensive and easy-to-understand control of the Clavinova's operations (page 16).

## ● **Wealth of Rich, Realistic Voices**

The CVP-103 has a wide variety of authentic and dynamic voices, including 195 original voices, 480 XG voices, and 12 drum/SFX kits. These include exceptionally natural-sounding piano, strings and brass voices, and the particularly expressive "SweetTrumpet" voice. Moreover, you can play realistic drum and percussion sounds directly from the keyboard (page 31).

## ● **Playback of Song Disks**

The Clavinova can play back various commercially available song disks. With the appropriate disk software, you can play the piano part of the song yourself along with a full orchestra or backing band (page 93). If the software contains lyrics, you can display them on the Clavinova's LCD.

## ● **Special Guide Functions for Easy Learning**

With the appropriate disk software, the LCD display and guide lamps help you learn songs by showing you when and where to play the proper notes. The three-step system helps you to master each song quickly and easily (page 105).

## ● **Fun, Dynamic Automatic Accompaniment**

The Auto Accompaniment of the Clavinova gives you full, exciting instrumental backing in your favorite music styles, according to the chords you play (page 57). There's even a wide selection of "Pianist" styles that allow you to enjoy solo piano accompaniment (page 58). Choose from 160 accompaniment styles, or create your own custom styles (page 73).

## ● **Easy Access to a Variety of Musical Enjoyment**

The Clavinova offers several ways to change panel settings without a lot of fuss. You can use the One Touch Setting feature to select from four sets of voice, effect, and other settings appropriate to each accompaniment style (page 72). Or access the Music Database to choose from 463 sets of style and voice settings, selectable by title or style (page 67). You can even save your current setup for instant recall later using the handy Registration function (page 89).

## ● **Easy-to-use Recording Features**

You can record songs using a variety of methods, depending on your keyboard expertise and preference. Choose from the Quick Recording, Track Recording, and Chord Sequence Recording functions (page 110).

## ● **Convenient TO HOST Terminals for Direct Connection to Computers**

The Clavinova can be used as a high-quality sound source to play back music software for computers. It can also be used as a master keyboard, to enter performance data and create music with a computer (page 160).

# Table of Contents

## CHAPTER 1: Getting Ready

<b>About This Manual</b>	8
<b>Handling the Floppy Disk Drive (FDD) and Floppy Disks</b>	9
<b>Setting Up the Clavinova</b>	10
Music Stand	10
Key Cover (Where Present)	10
Turning the Power On and Off	11
Headphones	11
Other Connections	11
<b>Panel Controls and Terminals</b>	12
<b>Playing the Demo Songs</b>	14

## CHAPTER 2: Basic Operation

<b>Using the LCD Display Controls</b>	16
Selecting a Function	16
Changing a Setting	17
Changing a Setting in a Menu Display	18
Displaying a Different Page	19
Resetting a Function's Value	19
Using Functions in Non-rounded Rectangles	20
Exiting to the Main Display	21
Using the Direct Access Function	21
<b>Adjusting the Volume</b>	23
Adjusting the Overall Volume	23
Adjusting the Accompaniment or Song Volume	23
Setting the Keyboard Volume	23
Adjusting Accompaniment or Song Part Levels	24
<b>Using the Metronome</b>	25
Using the Metronome	25
Changing the Metronome Settings	26
<b>Using the Help Mode</b>	27

## CHAPTER 3: Voices

<b>Selecting Voices</b>	29
Selecting a Voice from the VOICE SELECT Display	29
Selecting Voices from the Main Display	30
Keyboard Percussion	31
Changing the Keyboard Settings for the Main Voice	31
<b>Playing Two Voices Simultaneously — Dual Mode</b>	33
Selecting the Second Voice	33
Changing the Main Voice in Dual Mode	33
Changing the Keyboard Settings for the Second Voice	34
Exiting the Dual Mode	35
<b>Playing Two Voices on Different Sides of the Keyboard — Split Mode</b>	36

Selecting the Left Voice	36
Changing the Main Voice in Split Mode	36
Changing the Keyboard Settings for the Left Voice	37
Using the Dual and Split Functions Simultaneously	39
Exiting the Split Mode	39

<b>Using the Pedals</b>	40
Damper Pedal (Right)	40
Sostenuto Pedal (Center)	40
Soft Pedal (Left)	40

## CHAPTER 4: Reverb and Other Effects

<b>Reverb</b>	41
Turning the Reverb On or Off	41
Changing the Reverb Settings	41

<b>Chorus</b>	44
Changing the Chorus Settings	44

<b>Voice Effects</b>	46
Turning the Effects On	46
Changing the Effect Settings	46

## CHAPTER 5: Accompaniment Styles (Rhythm and Auto Accompaniment)

<b>Selecting Accompaniment Styles</b>	49
Selecting a Style	49

<b>Playing the Accompaniment Styles</b>	51
Varying the Style	51
Starting the Accompaniment Style	52
Stopping the Accompaniment Style	55

<b>Playing with the Auto Accompaniment</b>	57
Using the Auto Accompaniment	57
Starting the Auto Accompaniment	58
Stopping the Auto Accompaniment	58
Changing the Auto Accompaniment Settings	59
Adjusting Individual Part Levels	65

<b>Other Auto Accompaniment Functions</b>	67
Music Database	67
Harmony	69
One Touch Setting	72

<b>Creating Your Own Styles</b>	73
Recording a Custom Style	73
Other Custom Style Functions	80
Playing Back Your Custom Styles	84
Messages in Custom Style Mode	84

<b>Using Style Files</b>	86
About the Yamaha Style File Format	86
Loading Styles from a Disk	86
Playing Loaded Style Files	88

CHAPTER 6:

**Registrations**

**Using Registrations(Registering and Recalling Panel Setups)** 89

Storing a Panel Setup ..... 89

Recalling the Registered Panel Settings ..... 90

Protecting Panel Settings ..... 91

CHAPTER 7:

**Song Control**

**Song Playback** 93

Song Playback ..... 93

Part Cancel ..... 97

Assignment of Tracks to 1/RIGHT and 2/LEFT, and Voice Assignment ..... 98

Overall Song Playback Volume Control ..... 99

Adjustment of Track Settings ..... 100

Changing Settings in the MIXER Display ..... 100

Repeat Functions ..... 101

Other Playback Controls ..... 103

Playing Other Types of Music Data ..... 104

**Guide Control** 105

Guide Methods and Piano Roll ..... 105

Using the Guide Function ..... 106

Other Guide-related Functions ..... 108

**Song Recording** 110

Recording Setup: Disk Format ..... 111

Quick Recording ..... 112

Track Recording (Multi-track Recording) ..... 115

Adding New Tracks ..... 118

Punch-in/out Recording ..... 118

**Chord Sequence** 121

Other Chord Sequence Functions ..... 124

**Other Record Edit Functions** 126

Setup Memory ..... 126

Song Name ..... 127

Track Edit ..... 128

Initial Edit (Changing the Initial Data) ..... 130

Making Settings in the INITIAL EDIT Display ..... 131

**Recording Without a Disk** 133

About the CVP MEMORY Song ..... 133

CHAPTER 8:

**The Utility Functions**

**Keyboard** 136

FUNCTION [KEYBOARD 1] Display — page 1 ..... 136

FUNCTION [KEYBOARD 2] Display — page 2 ..... 137

**Pedal** 138

FUNCTION [PEDAL] Display — page 3 ..... 138

**Disk** 139

FUNCTION [DISK 1] Display — page 4 ..... 139

FUNCTION [DISK 2] Display — page 5 ..... 142

FUNCTION [DISK 3] Display — page 6 ..... 144

FUNCTION [DISK 4] Display — page 7 ..... 145

FUNCTION [DISK 5] Display — page 8 ..... 146

**MIDI** 147

FUNCTION [MIDI 1] Display — page 9 ..... 147

FUNCTION [MIDI 2] Display — page 10 ..... 148

FUNCTION [MIDI 3] Display — page 11 ..... 149

FUNCTION [MIDI 4] Display — page 12 ..... 150

**Backup** 152

FUNCTION [BACKUP 1] Display — page 13 ..... 152

FUNCTION [BACKUP 2] Display — page 14 ..... 153

**Utility** 154

FUNCTION [MICRO TUNING] Display — page 15 ..... 154

FUNCTION [SCALE TUNING] Display — page 16 ..... 155

CHAPTER 9:

**Connections**

**Audio Connections** 158

Headphones ..... 158

Audio Input and Output ..... 158

**Data Connections** 160

Connecting MIDI Equipment ..... 160

Connecting to a Host Computer ..... 160

**APPENDICES**

**Effect Type Lists** 162

**Messages** 165

**Troubleshooting** 170

**MIDI and Data Compatibility** 172

**Index** 173

# CHAPTER 1: Getting Ready

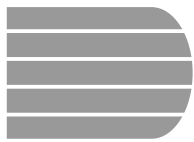

## About This Manual.....

This section explains the notation conventions that are used throughout this manual.

### ■ Square brackets [ ] .....

Square brackets enclose the names of panel buttons, sliders, and connectors as they appear on your Clavinova. For example, the DEMO button is expressed as **[DEMO]** in this manual.

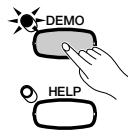

### ■ Bold characters .....

Bold type represents items shown in the LCD display, as well as the corresponding LCD buttons (i.e., the buttons directly below, or to the left or right of, these items). For example, the phrase “Select **RIGHT1 VOICE**” means that you should press the button directly below the “**RIGHT1 VOICE**” label at the bottom of the display.



### ■ Arrows in Operation Explanations .....

Different types of arrows are used to distinguish the steps of an operation from its results.

#### Operation steps

♥ > ♣ ...indicates that you should do ♥, then do ♣.

#### Operation results

♥ → ♠ ...indicates that doing ♥ results in ♠.



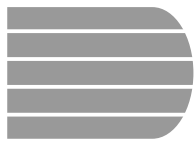

# Handling the Floppy Disk Drive (FDD) and Floppy Disks.....

## ● Precautions

Be sure to handle floppy disks and treat the disk drive with care. Follow the important precautions below.

## ● Compatible Disk Type

3.5" 2DD and 2HD type floppy disks can be used.

## ■ Inserting/Ejecting Floppy Disks .....

### To insert a floppy disk into the disk drive:

Hold the disk so that the label of the disk is facing upward and the sliding shutter is facing forward, towards the disk slot. Carefully insert the disk into the slot, slowly pushing it all the way in until it clicks into place and the eject button pops out.

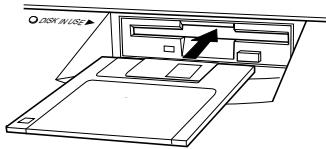

### To eject a floppy disk:

Before ejecting the disk, be sure to confirm that the FDD is stopped (check if the [DISK IN USE] lamp is off). Press the eject button slowly as far as it will go; the disk will automatically pop out. When the disk is fully ejected, carefully remove it by hand.

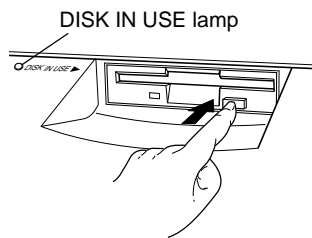

Never attempt to remove the disk or turn the power off during recording, reading and playing back. Doing so can damage the disk and possibly the disk drive.

If the eject button is pressed too quickly, or if it is not pressed in as far as it will go, the disk may not eject properly. The eject button may become stuck in a half-pressed position with the disk extending from the drive slot by only a few millimeters. If this happens, do not attempt to pull out the partially ejected disk, since using force in this situation can damage the disk drive mechanism or the floppy disk. To remove a partially ejected disk, try pressing the eject button once again, or push the disk back into the slot and then repeat the eject procedure.

Be sure to remove the floppy disk from the disk drive before turning off the power. A floppy disk left in the drive for extended periods can easily pick up dust and dirt that can cause data read and write errors.

## ■ Cleaning the Disk Drive Read/Write Head .....

- Clean the read/write head regularly. This instrument employs a precision magnetic read/write head which, after an extended period of use, will pick up a layer of magnetic particles from the disks used that will eventually cause read and write errors.
- To maintain the disk drive in optimum working order Yamaha recommends that you use a commercially-available dry-type head cleaning disk to clean the head about once a month. Ask your Yamaha dealer about the availability of proper head-cleaning disks.
- Never open or close the key cover while a disk is extending from the drive (i.e. in the ejected position). The key cover may contact the disk, – possibly damaging the disk or even the disk drive.
- Never insert anything but floppy disks into the disk drive. Other objects may cause damage to the disk drive or floppy disks.

## ■ About the Floppy Disks .....

### To handle floppy disks with care:

- Do not place heavy objects on a disk or bend or apply pressure to the disk in any way. Always keep floppy disks in their protective cases when they are not in use.
- Do not expose the disk to direct sunlight, extremely high or low temperatures, or excessive humidity, dust or liquids.
- Do not open the sliding shutter and touch the exposed surface of the floppy disk inside.
- Do not expose the disk to magnetic fields, such as those produced by televisions, speakers, motors, etc., since magnetic fields can partially or completely erase data on the disk, rendering it unreadable.
- Never use a floppy disk with a deformed shutter or housing.
- Do not attach anything other than the provided labels to a floppy disk. Also make sure that labels are attached in the proper location.

### To protect your data (Write-protect Tab):

To prevent accidental erasure of important data, slide the disk's write-protect tab to the "protect" position (tab open).

### Data backup

For maximum data security Yamaha recommends that you keep two copies of important data on separate floppy disks. This gives you a backup if one disk is lost or damaged. To make a backup disk use the Disk Copy function on page 142.

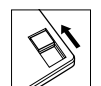
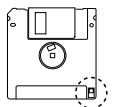

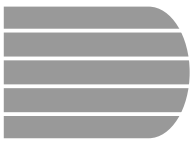

# Setting Up the Clavinova.....

## Music Stand

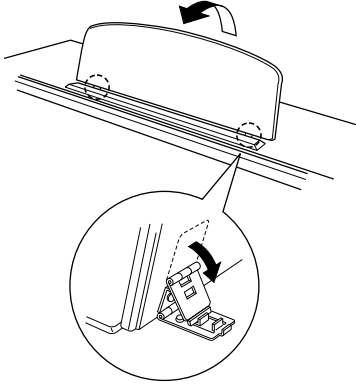

### ■ To raise the music stand: .....

- 1 Pull the stand up and toward yourself as far as it will go.
- 2 Flip down the two metal supports at the left and the right on the rear of the music stand.
- 3 Lower the music stand so that it rests on the metal supports.

As the illustration shows, the angle of the music stand can be set in one of three positions, according to the position of the metal supports. Set the left and right metal supports to the same position.

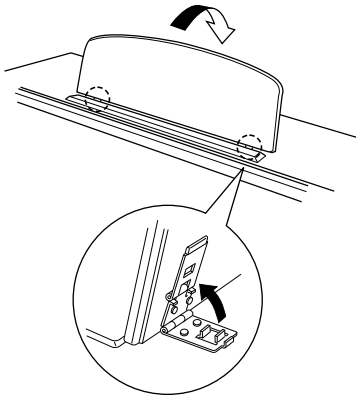

### ■ To lower the music stand: .....

- 1 Pull the music stand toward yourself as far as it will go.
- 2 Raise the two metal supports until they are flat against the rear surface of the stand.
- 3 Gently lower the music stand backward until it is all the way down.

#### **⚠ CAUTION**

- Do not try to use the music stand in a half-raised position. Also, when lowering the stand, let the stand all the way down before releasing it.

## Key Cover (Where Present)

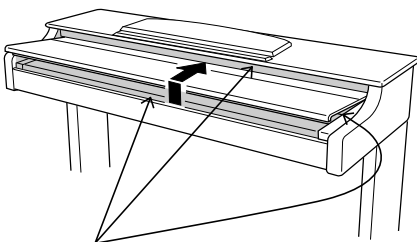

Be careful to avoid catching your fingers when opening or closing the cover.

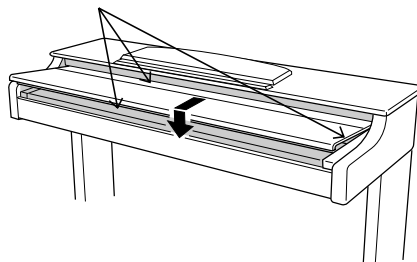

### ■ To open the key cover: .....

- 1 Lift the cover slightly (not too much).
- 2 Slide the cover open.

### ■ To close the key cover: .....

- 1 Slide the cover toward you.
- 2 Gently lower the cover over the keys.

#### **⚠ CAUTION**

- Hold the cover with both hands when moving it, and do not release it until it is fully opened or closed. Be careful to avoid catching fingers (yours or others) between the cover and main unit.
- Do not place objects on top of the key cover. Small objects placed on the key cover may fall inside the instrument when the cover is opened, and may be impossible to remove. This could cause electric shock, short circuit, fire or other serious damage to the instrument.

## Turning the Power On and Off

### 1 Connect the power cord.

Insert the plugs at the ends of the cord, one into the AC INLET on the bottom panel of the Clavinova, and the other into a standard AC outlet. In some areas, a plug adapter may be provided to match the pin configuration of the AC wall outlets in your area.

### 2 Press the [POWER] switch.

The main display appears in the LCD display. (Initially, the voice **Grand Piano** and the accompaniment style **8 Beat 1** are selected.) The power lamp below the lower left end of the keyboard also lights.

### 3 Adjust the LCD.

If the LCD is difficult to read, adjust the contrast with the [CONTRAST] knob at the left of the LCD.

### 4 Adjust the volume.

Use the [MASTER VOLUME] slider to adjust the volume to an appropriate level.

- When you're ready to turn off the power, press the [POWER] switch again. Both the LCD display and the power lamp below the left end of the keyboard will turn off.

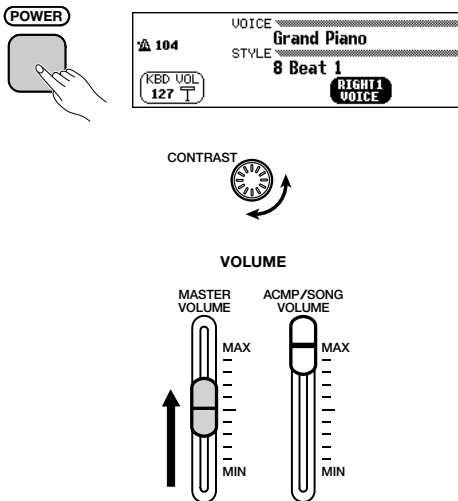

## Headphones

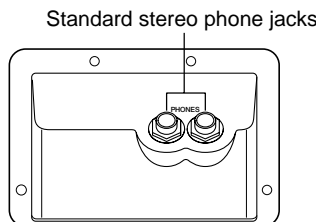

Connect a set of stereo headphones (optional) to the [PHONES] jack. When headphones are connected, the internal speaker system is automatically shut off. Since the Clavinova has two PHONES jacks, two sets of headphones can be used simultaneously, allowing two people to enjoy listening to the performance.

## Other Connections

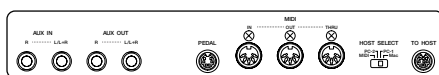

Your Clavinova is equipped with a variety of jacks and terminals that let you connect it to other audio and MIDI equipment. These connectors are located at the left end of the unit on the rear panel.

You can connect other instruments that you want to play through the Clavinova's speakers to the AUX IN jacks, or output the Clavinova's sound to external speakers using the AUX OUT jacks. Use the MIDI terminals if you want the Clavinova to control — or be controlled by — another MIDI instrument. There's even a TO HOST terminal that lets you connect the Clavinova directly to a personal computer.

Be sure to turn the power off when connecting or disconnecting other equipment. See the instructions in Chapter 9 of this manual for details.

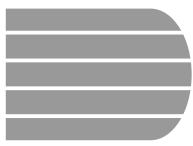

# Panel Controls and Terminals .....

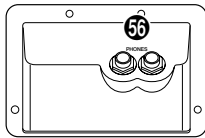
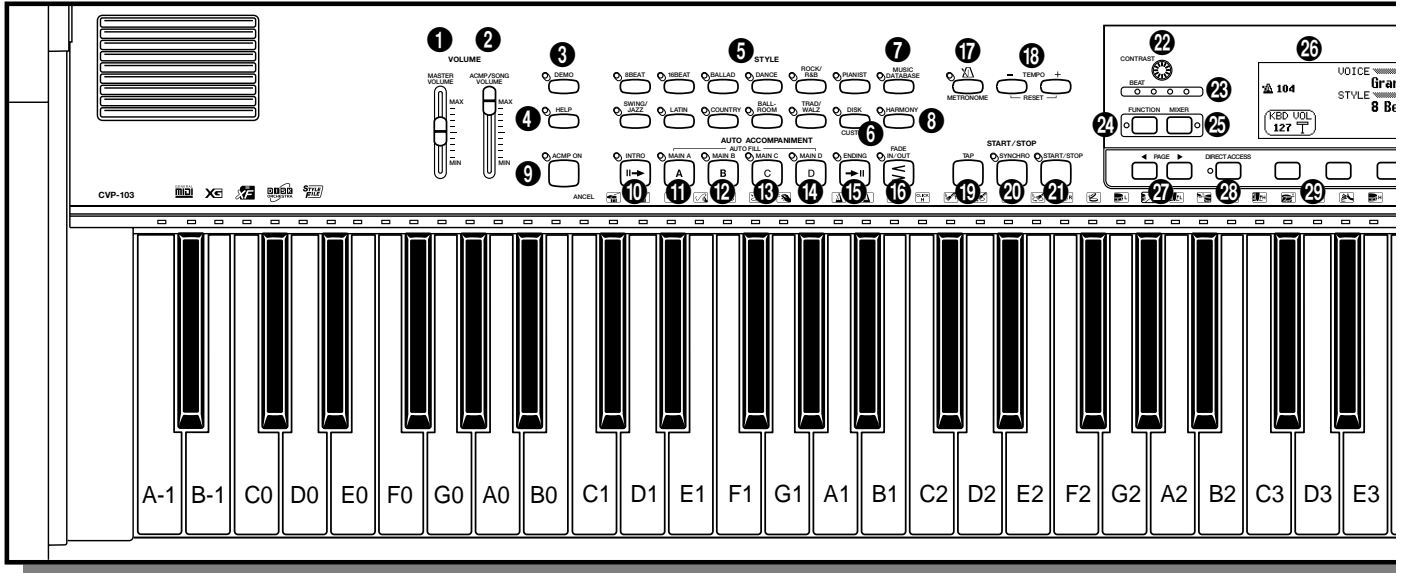
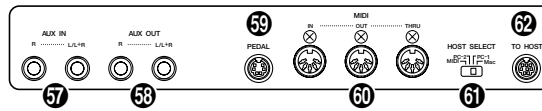

## Volume Section

- 1 [MASTER VOLUME] ..... page 23
- 2 [ACMP/SONG VOLUME] ..... page 23

## Special Mode Control Section

- 3 [DEMO] ..... page 14
- 4 [HELP] ..... page 27

## Accompaniment Style Section

- 5 STYLE buttons ..... page 49
- 6 [DISK/CUSTOM] ..... page 73
- 7 [MUSIC DATABASE] ..... page 67
- 8 [HARMONY] ..... page 69

## Auto Accompaniment Section

- 9 [ACMP ON] ..... page 57
- 10 [INTRO] ..... page 54
- 11 [MAIN A] ..... page 51
- 12 [MAIN B] ..... page 51
- 13 [MAIN C] ..... page 51
- 14 [MAIN D] ..... page 51
- 15 [ENDING] ..... page 55
- 16 [FADE IN/OUT] ..... pages 55, 56

## Metronome Section

- 17 [METRONOME] ..... page 25

- 18 TEMPO [-], [+] ..... page 25

## Start/Stop Section

- 19 [TAP] ..... page 53
- 20 [SYNCHRO] ..... page 53
- 21 [START/STOP] ..... pages 52, 55

## Display Control Section

- 22 [CONTRAST] ..... page 11
- 23 [BEAT] lamps ..... page 52
- 24 [FUNCTION] ..... page 136
- 25 [MIXER] ..... page 24
- 26 LCD display ..... page 16
- 27 PAGE [◀], [▶] ..... page 19
- 28 [DIRECT ACCESS] ..... page 21
- 29 LCD buttons ..... page 18
- 30 [EXIT] ..... page 21
- 31 Data dial ..... page 17
- 32 [-], [+] ..... page 17

## Song Control Section

- 33 [SONG] ..... page 94
- 34 [PLAY/STOP] ..... page 95
- 35 [REC] ..... page 113
- 36 [PAUSE] ..... page 103
- 37 [REW] ..... page 103
- 38 [FF] ..... page 103

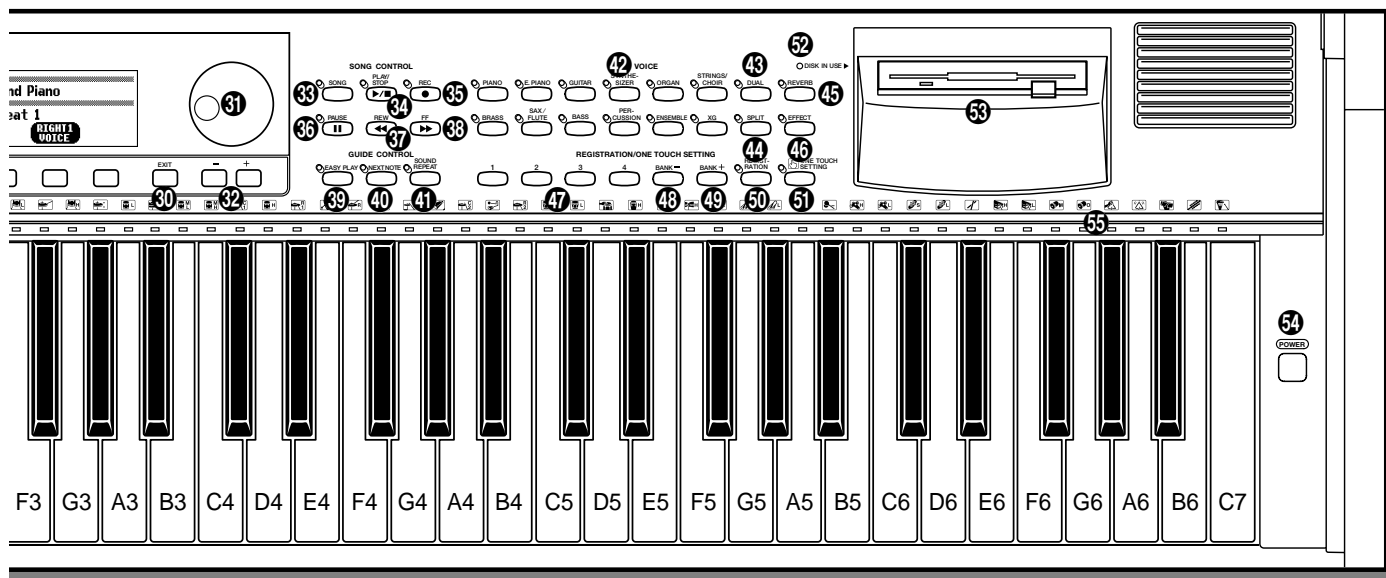
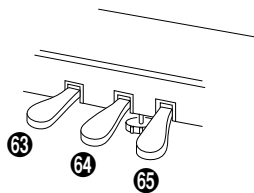

### Guide Control Section

- 39 [EASY PLAY] ..... page 105
- 40 [NEXT NOTE] ..... page 105
- 41 [SOUND REPEAT] ..... page 106

### Voice Section

- 42 VOICE buttons ..... page 29
- 43 [DUAL] ..... page 33
- 44 [SPLIT] ..... page 36
- 45 [REVERB] ..... page 41
- 46 [EFFECT] ..... page 46

### Registration/One Touch Setting Section

- 47 [1] through [4] ..... pages 72, 90
- 48 [BANK -] ..... page 89
- 49 [BANK +] ..... page 89
- 50 [REGISTRATION] ..... page 90
- 51 [ONE TOUCH SETTING] ..... page 72
- 52 [DISK IN USE] lamp ..... page 9
- 53 Floppy disk drive (3.5") ..... page 9
- 54 [POWER] ..... page 11
- 55 Keyboard guide lamps ..... page 109

### Connectors

- 56 [PHONES] ..... page 158
- 57 AUX IN [L/L+R], [R] ..... page 158
- 58 AUX OUT [L/L+R], [R] ..... page 159

- 59 [PEDAL] ..... page 42 in the Reference Booklet
- 60 MIDI [IN], [OUT], [THRU] ..... page 160
- 61 [HOST SELECT] ..... page 160
- 62 [TO HOST] ..... page 160

### Pedals

- 63 Soft pedal ..... page 40
- 64 Sostenuto pedal ..... page 40
- 65 Damper pedal ..... page 40

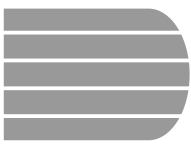

# Playing the Demo Songs .....

The Clavinova features a total of 50 demo songs: 4 feature songs, 24 special pieces showcasing the voices, and 22 pieces showcasing the styles. Listen to them all and hear what the Clavinova can do.

## 1 Call up the Demo Play mode. ....

Press [DEMO]. The lamps of the STYLE button and VOICE button flash continuously, and the DEMO display appears.

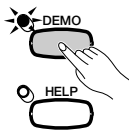

## 2 Select the desired play mode. ....

Select the desired play mode by pressing the rightmost LCD button. The following three modes are available:

<b>ALL</b>	All the songs play back continuously in order, starting from the selected song. Playback continues repeatedly until stopped.
<b>RANDOM</b>	All the songs play back randomly, starting from the selected song. Playback continues repeatedly until stopped.
<b>SINGLE</b>	Only the selected song plays back. When the song is finished, playback stops automatically.

## 3 Select the song and start playback. ....

When you select a song, the demo automatically starts playing in the selected play mode. There are three ways to select a demo song, as described below:

**(A) To listen to one of the featured demo songs, press one of the buttons under the numbers 1 through 4 in the display.**

→ The current song number is highlighted during playback.

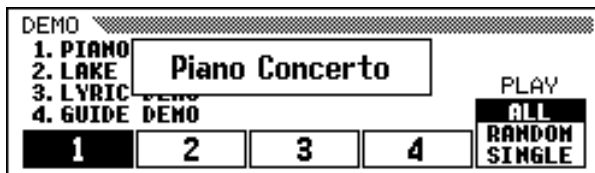

### NOTE

- You can also start the demo playback, beginning with the first feature song, by pressing [START/STOP] or [PLAY/STOP].
- For a complete list of the Clavinova's demo songs, refer to page 9 of the Reference Booklet.

**(B) To listen to a voice demo, press the VOICE button corresponding to the desired voice category.**

- ▶ Playback starts from the first demo song for the selected category. The lamp of the corresponding VOICE button flashes.

**NOTE**

There are two demo songs for each voice category. To skip to the second song, press the flashing button a second time.

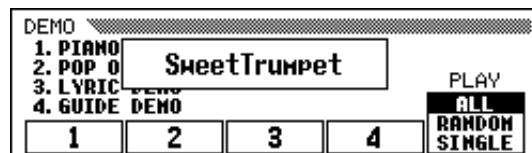
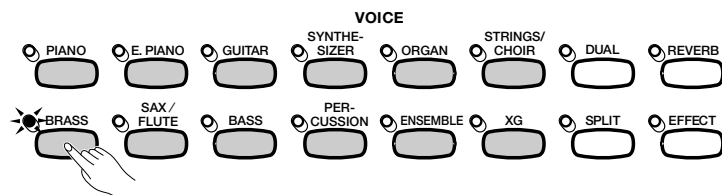

**(C) To listen to a style demo, press the STYLE button corresponding to the desired style category.**

- ▶ Playback starts from the first demo song for the selected category. The lamp of the corresponding STYLE button flashes.

**NOTE**

There are two demo songs for each style category. To skip to the second song, press the flashing button a second time.

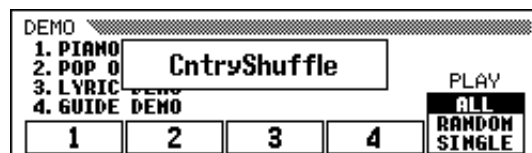
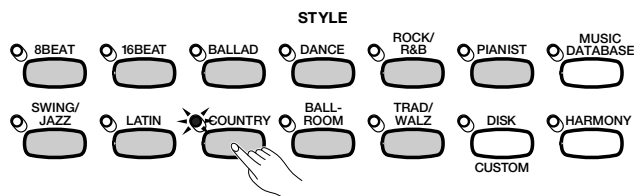

## 4 Adjust the volume. ....

Use the [MASTER VOLUME] slider to adjust the volume.

**NOTE**

The [ACMP/SONG VOLUME] control cannot be used.

## 5 Stop the demo playback. ....

To stop playback, press either [START/STOP] or [PLAY/STOP], or the LCD button corresponding to the song that's currently playing.

**NOTE**

**To change songs during playback:**  
Press the LCD button, VOICE button, or STYLE button of another song; the song then changes. When ALL or RANDOM is selected as the play mode, the Clavinova will play other songs when the selected song is finished.

## 6 Exit the Demo mode. ....

To exit the Demo mode, press [DEMO] again (or press [EXIT]).

### ● Playing Along with the Demo Songs

You can play the keyboard while a demo song is playing back. You can also change the tempo (page 25) and use the [REW], [FF] and [PAUSE] buttons. When you play **3. Lyric Demo**, the Clavinova will display the lyrics so you can sing (as well as play) along. Also, you can use the Guide function (page 105) while the Clavinova is playing **4. GUIDE Demo**. You cannot change the voice selection while the demo is playing, however.

**NOTE**

Demo song data is not output through the [MIDI OUT] terminal; however, your keyboard performance data is output.

# CHAPTER 2: Basic Operation



## Using the LCD Display Controls .....

You will refer to the LCD display frequently as you operate your Clavinova. This section consists of a short tutorial that will help you learn how to read the LCD display and use the related controls.

### Selecting a Function

Many of the Clavinova's functions are displayed at the bottom of the LCD. The main display shown below contains two functions: **KBD VOL** and **RIGHT1 VOICE**. These items are displayed in rounded rectangles, which means they represent settings that can be changed.



Before you can change a function's setting, however, you have to select it first. In the main display, the **RIGHT1 VOICE** function is highlighted, indicating that this function is currently selected.

To select a function, press and quickly release the LCD button directly below that function. For example, you can select **KBD VOL** by pressing the leftmost LCD button.

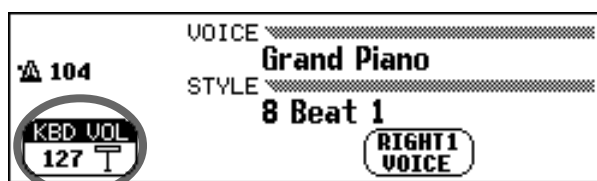

Press to select.

#### NOTE

##### Main display

Remember, the main display is the display that appears first when you turn the power on.

#### NOTE

##### Highlighted items

Selected items are highlighted (i.e., white letters on a dark background).

#### NOTE

##### LCD buttons

The five LCD buttons under the LCD display represent different functions, depending on the contents of the display.



## Changing a Setting

There are several ways to change a function's value. Here are two of the main ways:

### ■ Using the data dial or [-] and [+] buttons .....

Once you have selected a function, you can change its setting with the data dial or the [-] and [+] buttons. Since you have just selected **KBD VOL**, try turning the dial or pressing the [-] button until it reads **0**.

The **KBD VOL** function sets the keyboard volume. When you set it to **0**, you will find that the keyboard won't produce any sound, no matter how high you set the **[MASTER VOLUME]** slider!

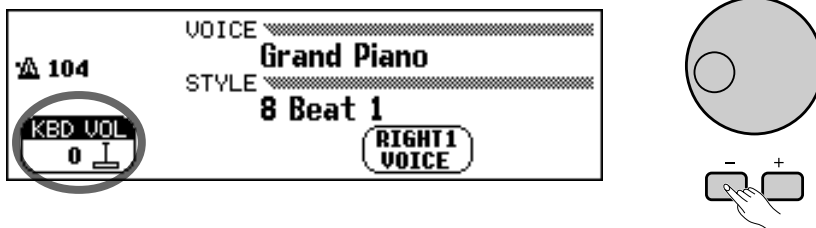

#### NOTE

You can press the [-] and [+] buttons repeatedly to change the value a little, or hold them down to change it quickly.

#### NOTE

Refer to page 23 for details on the **KBD VOL** function.

### ■ Using the LCD buttons .....

You can also increase a setting by simply pressing and holding the corresponding LCD button. For now, since you'll want to hear your keyboard later on, press and hold the leftmost LCD button until the value for **KBD VOL** is back up to **127**.

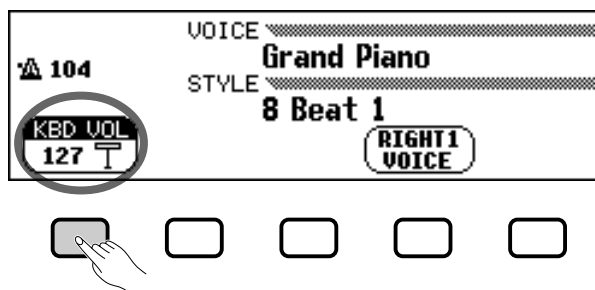

Hold down to increase.

Once you've got the keyboard volume back where it belongs, you can learn about a couple of other ways to change settings.

#### NOTE

This is why you should release the LCD button quickly when you select a function: you could end up raising its value when you want to lower it!

## Changing a Setting in a Menu Display

You can use either of the methods described previously to change the current voice selection. Just press **RIGHT1 VOICE** and hold the button down, or use the data dial or the [+] button to scan through the options. Try listening to a few of the voices while you're at it...

The problem with this method is that it can be hard to find the voice you're looking for — after all, the Clavinova has more than 600 voices! So you'll probably want to use a menu display to see what your choices are. Try pressing the [PIANO] button now.

**NOTE**

**Voice**

A voice is one of the sounds the Clavinova uses to make music.

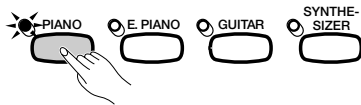

When you press one of the VOICE buttons, the LCD displays a new set of functions listing the voices of that type. You should now be looking at a menu of piano voices.

**NOTE**

Refer to page 29 for more details about selecting voices.

### ■ Using the LCD buttons

Each piano voice in this display is listed as a separate function in a rounded rectangle. This means that you can use the LCD buttons to select voices, just like you did to select the **KBD VOL** and **RIGHT1 VOICE** functions at the beginning of this tutorial.

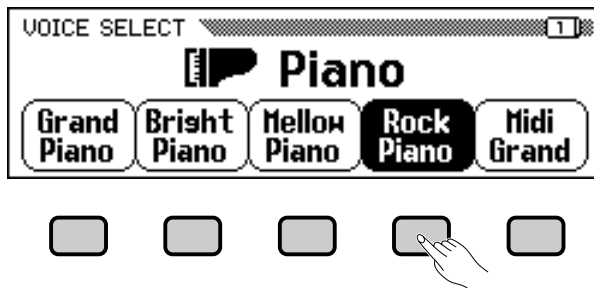

Press an LCD button to select the corresponding voice.

### ■ Using the data dial or [-] and [+] buttons

There is another way to select voices in this display. You can use the data dial or the [-] and [+] buttons to change the selection. Press [-] or turn the data dial counterclockwise to select a voice to the left; press [+] or turn the dial clockwise to select a voice to the right.

**NOTE**

**Menu displays**

You will use menu displays for only two purposes: to select a voice, as shown here, or to select an accompaniment style (page 49).

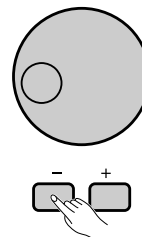

Use the data dial or [-] and [+] buttons to select a voice.

Keep in mind that you can use the data dial or [-] and [+] buttons to select functions only when viewing a *menu display*. In other displays, these controls will change the value of the currently selected function instead.

Try selecting different piano voices in this display before you move on to the next step.

## Displaying a Different Page

As you were trying out the piano voices in the preceding step, you may have been surprised to see all the voice names suddenly replaced by an entirely different set of voices. Specifically, this occurs when you select the rightmost voice in the display (**Midi Grand**), then turn the data dial clockwise or press the **[+]** button.

This happens because the CVP-103 has more piano voices than it can fit in the display. When one of the Clavinova's features includes more functions than will fit in the display, the functions are divided among two or more *display pages*. The VOICE SELECT Piano display consists of two display pages, as shown below:

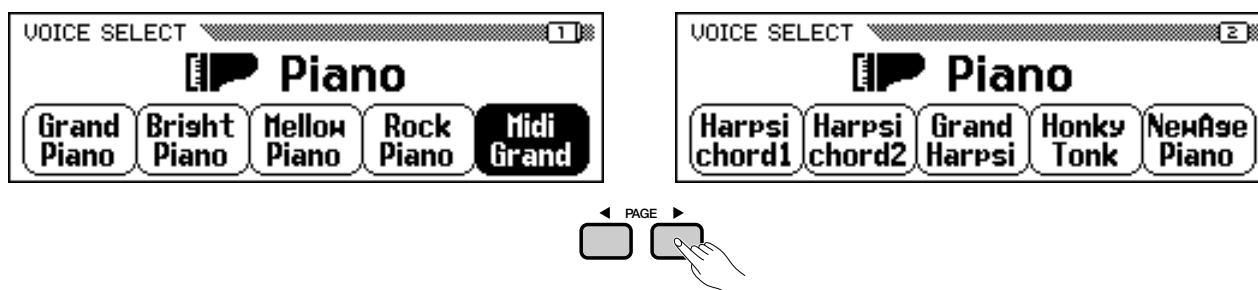

Use the PAGE buttons to switch between pages.

When a display is divided into pages, you can use PAGE buttons to change pages. Try it: press the **[◀]** button to see page 1, or the **[▶]** button to see page 2. Once you have displayed the desired page, you can use the LCD buttons select a voice in that page as described in the preceding step.

**NOTE**

**Display pages**

Some displays are divided into two or more pages, indicated by a series of overlapping boxes in the upper right corner of the display. The number in the topmost box is the number of the current display page.

**NOTE**

Refer to page 138 for details about the functions on the FUNCTION [PEDAL] display page.

## Resetting a Function's Value

After you have changed a function's value, you may find you want to restore its basic setting. To demonstrate this, we'll have to look at another of the Clavinova's displays. Press the **[FUNCTION]** button.

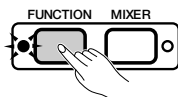

This button calls up one of the Clavinova's FUNCTION displays. You can use this display to tune and transpose the keyboard.

The **TUNE** function in this display corresponds to two LCD buttons labeled **▼** and **▲**. You can use these buttons to tune the keyboard up or down. Press and hold the **▼** button (or use the data dial or the **[-]** button) to tune the keyboard down as far as it will go.

**NOTE**

**Basic settings**

- The functions of the Clavinova are set to certain standard values or standard conditions when the instrument is shipped. These settings and conditions are called the basic settings.
- A function's basic settings are generally noted in the sidebar together with the possible settings for that function.
- You can also use the Recall function (page 153) to restore basic settings at any time.

**NOTE**

Refer to page 136 for details on the TUNE and TRANSPOSE functions.

## Using the LCD Display Controls

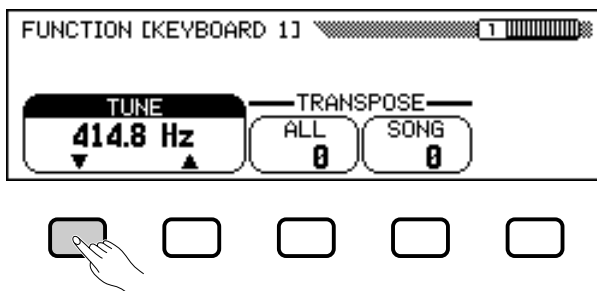

If you play a few notes, you'll notice that your Clavinova is flat by quite a bit. Now, let's assume that you want to reset the keyboard to the standard 440.0 Hz. You could use the ▲ button (or the data dial, or the [+] button) to return the value to its basic setting — but there's an easier way:

When a function has a basic setting, you can reset it to that value by pressing both the ▲ and ▼ buttons (or both the [-] and [+] buttons) simultaneously. Try doing this now.

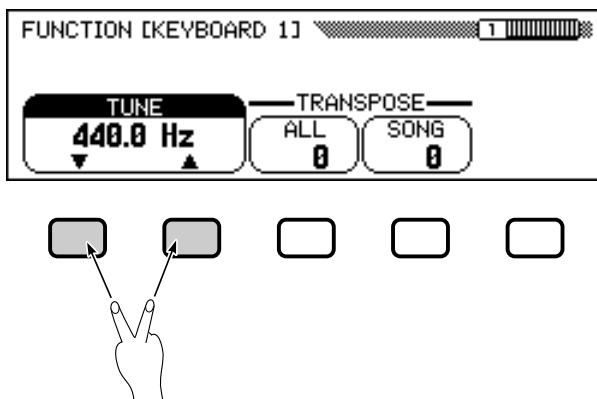

When you've got the keyboard back in tune, you're ready to go on to the next operation.

### NOTE

There are some functions whose settings cannot be returned to the basic value by pressing the ▲ and ▼ buttons (or [-] and [+] buttons) simultaneously.

## Using Functions in Non-rounded Rectangles

If you look at the upper right corner of the LCD, you'll notice that the FUNCTION display consists of several display pages. Press the PAGE [▶] key once to open the next page, which is titled FUNCTION [KEYBOARD 2]. We'll use the functions on this page to discuss the next operation.

In addition to the **FIXED VELOCITY** function, which is selected in this display, the FUNCTION [KEYBOARD 2] page has two functions in normal rectangles: **KEY TOUCH** and **VOICE SETTING**. Such functions cannot be selected; instead, pressing the corresponding LCD button changes the setting directly *without selecting the function*.



### NOTE

The **FIXED VELOCITY** function is described on page 137.

By pressing the LCD button under **KEY TOUCH**, for example, you can set the Clavinova's response to how hard you play. The value displayed in the rectangle switches from **NORMAL** to **SOFT**, then **FIXED**, then **HARD** — but the **FIXED VELOCITY** function remains selected.

The **VOICE SETTING** function determines whether reverb, chorus, effect, and other settings are automatically selected when a voice is selected. It works a little differently: when you press the LCD button, the highlighted setting switches between **AUTO** and **MANUAL**. Still, **FIXED VELOCITY** remains selected.

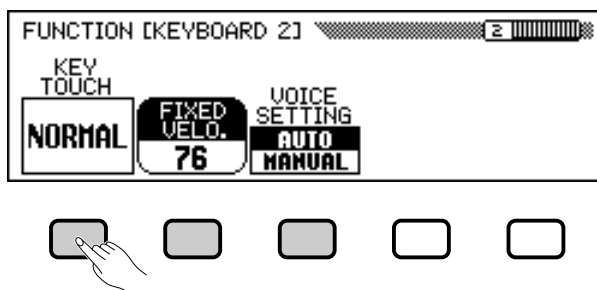

There are other sorts of functions that are displayed in non-rounded rectangles, like the ones you used to select a demo song in Demo mode (see page 14). The important thing to remember about these functions is that you don't *select* them, you *execute* them.

Now we're ready to return to the main display. First, however, set the **KEY TOUCH** and **VOICE SETTING** functions back to **NORMAL** and **AUTO**, respectively.

**NOTE**

For more details on the **KEY TOUCH** function, refer to page 137.

**NOTE**

For more details on the **VOICE SETTING** function, refer to page 137.

## Exiting to the Main Display

To exit the current display, press the **[EXIT]** button.

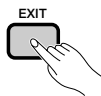

The main display should show the name of the last piano voice that you selected in the **VOICE SELECT** Piano display.

**NOTE**

You can usually use **[EXIT]** to get back to the main display. In some cases, however, this button will return you to a previous setting display instead. When this happens, pressing **[EXIT]** again will get you back to the main display.

## Using the Direct Access Function

The last function we need to discuss is Direct Access. The **[DIRECT ACCESS]** button lets you jump directly to pages with particularly useful settings. When you press **[DIRECT ACCESS]**, the “**Press a button to display corresponding settings**” message will appear in the LCD display.

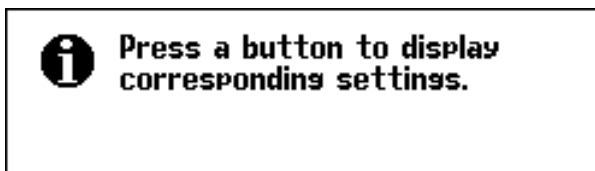

## Using the LCD Display Controls

This message will remain onscreen for about three seconds. Press the button corresponding to the settings you want to display before the message disappears.

Here is a list of pages you can access with Direct Access:

[DIRECT ACCESS] plus:	Displays:	See page:
[HARMONY]	HARMONY	69
[ACMP ON]	ACCOMPANIMENT MODE	59
[METRONOME]	METRONOME	26
Any VOICE button	KEYBOARD [RIGHT1] <sup>(1)</sup>	31
	KEYBOARD [RIGHT2] <sup>(2)</sup>	31
	KEYBOARD [LEFT] <sup>(3)</sup>	31
[DUAL]	KEYBOARD [RIGHT2]	34
[SPLIT]	KEYBOARD [LEFT]	37
[REVERB] <sup>(4)</sup>	REVERB	41
	REVERB DEPTH	43
[EFFECT] <sup>(4)</sup>	EFFECT	46
	EFFECT DEPTH	48
[REGISTRATION]	REGISTRATION [FREEZE]	91

### NOTE

You can also press an appropriate button while holding down the [DIRECT ACCESS] button.

### NOTE

<sup>(1)</sup> When RIGHT1 VOICE is selected in the main display.

<sup>(2)</sup> When RIGHT2 VOICE is selected in the main display.

<sup>(3)</sup> When LEFT VOICE is selected in the main display.

<sup>(4)</sup> Selects whichever page was most recently displayed.

### ● A Word about Messages

For ease of operation, the Clavinova displays various messages (like the message displayed by the Direct Access function as described above) that either prompt you to the next operation, ask for confirmation, or inform you that the last operation is not effective, valid, or appropriate. When such messages appear, follow the instructions as shown. For details about each message, please refer to the “Messages” section on page 165.

### ● Saving Your Changes

Now that you’ve started learning how to change the Clavinova’s settings, you may be wondering whether it will remember the changes you’ve made even after you’ve turned the power off. The answer is yes — but you need to tell it which settings you want it to remember.

By default, the Clavinova will not remember most of your setting changes. You have two ways to tell it which settings you want to remember:

- You can register your settings with the Registration function (page 89). Once you have registered your settings, you can restore them at any time by pressing a couple of buttons.
- You can instruct the Clavinova to remember certain settings when the power is off, and recall these settings when you turn the power back on. To do this, you need to change the settings of the Backup function (page 152).



# Adjusting the Volume .....

The Clavinova has two sliders that let you adjust the overall volume and the accompaniment or song playback volume. There are also settings that you can use to adjust the keyboard volume and the volume of each part of the automatic accompaniment or song.

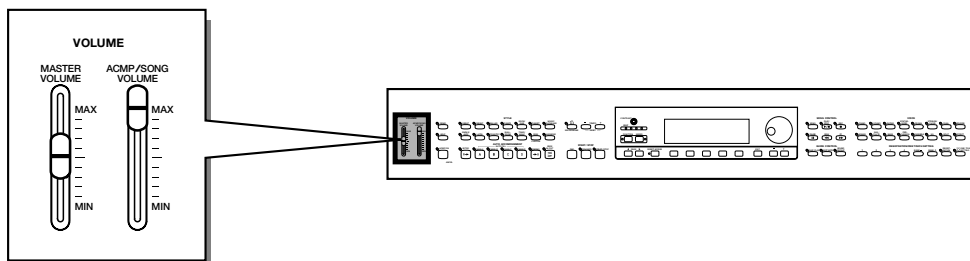

## Adjusting the Overall Volume

Use the [MASTER VOLUME] slider to set the overall volume of the Clavinova.

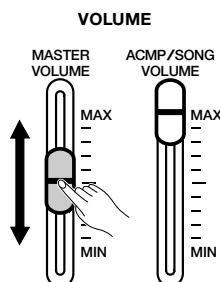

### NOTE

- The [MASTER VOLUME] slider also determines the output level of the signal at the [PHONES] jack.
- Signals input to the AUX IN jacks are also affected by the [MASTER VOLUME] setting; however, signals output via the AUX OUT jacks are not.

## Adjusting the Accompaniment or Song Volume

Use the [ACMP/SONG VOLUME] slider to set the playback volume of the automatic accompaniment and songs.

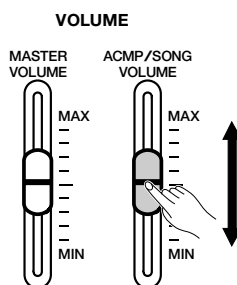

### NOTE

This control has no effect on the volume of your keyboard performance.

## Setting the Keyboard Volume

Select **KBD VOL** in the main display, then use the data dial or the [-] and [+] buttons to change the keyboard volume.

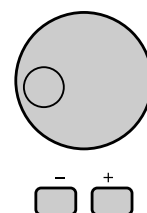
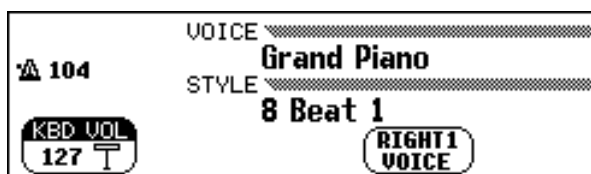

## Adjusting Accompaniment or Song Part Levels

Call up the MIXER display by pressing [MIXER]. In the Mixer display, the volume of Automatic Accompaniment and individual parts of a song can be adjusted. Press [MIXER] again (or [EXIT]) to return to the previous display.

There are two types of mixer display, as shown below.

### ● Automatic Accompaniment Mixer

This MIXER display appears when you're not using the Song mode. See "Adjusting Individual Part Levels" (page 65) for details.



### ● Song Mixer

This MIXER display appears in the Song mode. See "Adjusting Individual Track Levels" (page 100) for details.

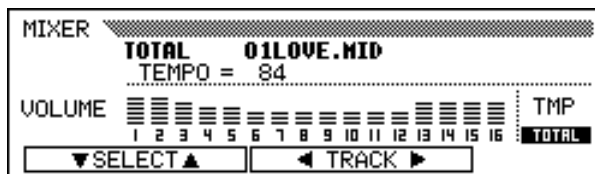





# Using the Metronome .....

The Clavinova features a convenient metronome that is ideal for practicing. The procedure for setting the metronome tempo can also be used to set the playback tempo for the Auto Accompaniment (page 49) and Song (page 93) modes.

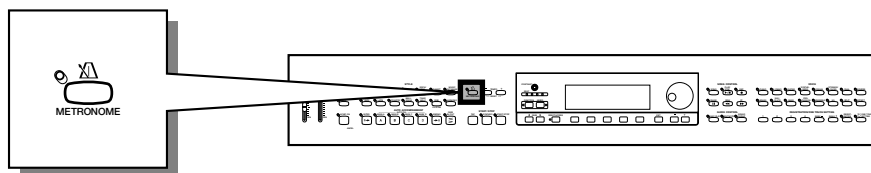

## Using the Metronome

You can start the metronome and set the tempo from any display, including the main display.

### Starting and Stopping the Metronome .....

To start the metronome, simply press the [METRONOME] button.

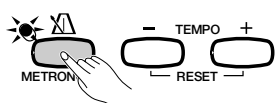

→ The [METRONOME] lamp lights, and the metronome starts keeping time (indicated by the flashing of the BEAT lamps).

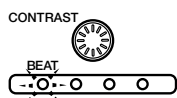

Press the [METRONOME] button again to stop the metronome.

### Adjusting the Tempo .....

The current tempo, indicated at the left edge of the display, depends on the selected style (see page 49). To change the tempo, press the TEMPO [-] and [+] buttons.

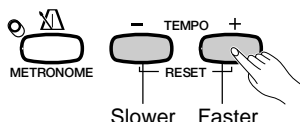

→ The tempo indication in the main display is highlighted, and the tempo changes.

You can either press TEMPO [-] or [+] buttons briefly to change the tempo value by one, or hold down the button to change it continuously.

When the tempo is highlighted in the display, you can also use the data dial or [-] and [+] buttons to set the tempo.

#### NOTE

- The metronome can also be used during playback in Auto Accompaniment (page 49) or Song mode (page 93).
- The metronome cannot be used when playing disk software that was recorded in free-tempo (see page 96).

#### NOTE

##### Tempo

- Range: 32 — 280
- Basic setting: Depends on style.

#### NOTE

##### Restoring the Basic Tempo

You can restore the preset tempo for the currently selected style by simultaneously pressing both TEMPO [-] and [+] buttons.

#### NOTE

##### During Style or Song Playback...

- If a style or song is started while the metronome is playing, the metronome will continue to sound along with the style or song.
- The metronome uses the time signature of the style or song instead of the BEAT setting during style or song playback.
- The metronome stops when the style or song stops.

## Changing the Metronome Settings

You can change the metronome's time signature and volume using the settings in the METRONOME page.

### ■ Displaying the Metronome Settings

To display the METRONOME page, press **[DIRECT ACCESS]**, then **[METRONOME]**.

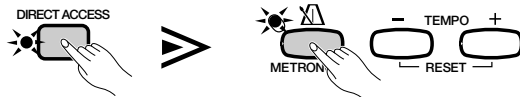

→ The METRONOME display appears.

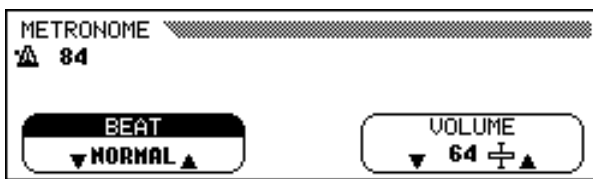

### ■ Setting the Beat (Time Signature)

Use the **BEAT** ▼ and ▲ buttons to change the time signature. (If the **BEAT** function is highlighted, you can also change its settings with the data dial or the [-] and [+] buttons.)

When **NORMAL** is selected, the metronome ticks steadily at the current tempo with no accented beats.

When **BEAT** is set to **2, 3, 4, or 5**, the metronome ticks off measures with the selected number of beats, playing a bell sound on the first beat of each measure.

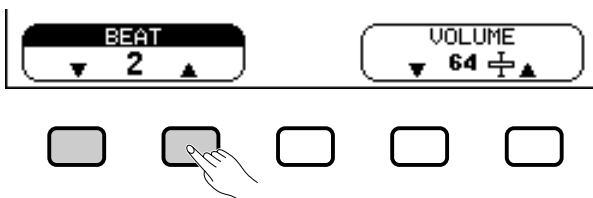

### ■ Setting the Metronome Volume

Use the **VOLUME** ▼ and ▲ buttons to change the metronome volume. (If the **VOLUME** function is highlighted, you can also change its settings with the data dial or the [-] and [+] buttons.)

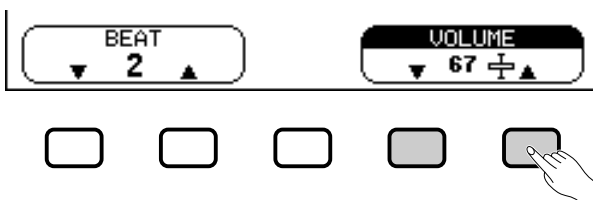

The volume of the metronome is determined by both the **VOLUME** function and the **[ACMP/SONG VOLUME]** slider (except in Song mode, in which case the volume of the metronome is not affected by the slider). If you use the slider, the playback volume for the Automatic Accompaniment (page 50) will also be affected.

#### NOTE

##### BEAT

- Settings: **NORMAL, 2 — 5**
- Basic setting: **NORMAL**

#### NOTE

##### VOLUME

- Range: **0 — 127**
- Basic setting: **64**



# Using the Help Mode .....

The Help mode provides convenient explanations of the main functions of the Clavinova. You can select help topics from a menu displayed on the LCD, or press a button on the panel to get help information related to that control.

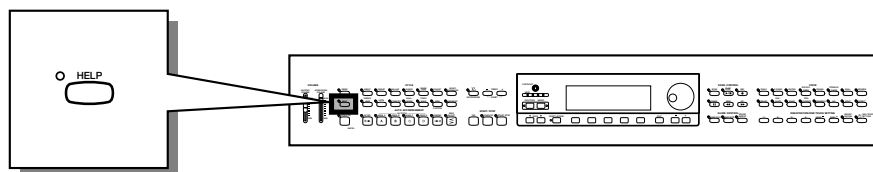

## 1 Call up the Help mode. ....

Press the [HELP] button.

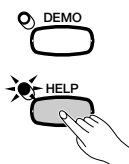

→ The Help menu display appears.

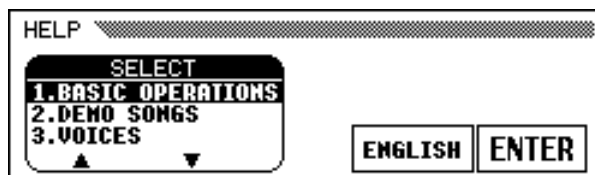

### NOTE

While the Help mode is active, no other operations can be performed.

## 2 Select the language if necessary. ....

Select the desired language for help (**ENGLISH, JAPANESE, GERMAN, FRENCH, or SPANISH**) by pressing the fourth LCD button.

### NOTE

The selected language is always backed up even after the power is turned off.

## 3 Select a help topic. ....

Use the **SELECT** ▲ and ▼ LCD buttons to select one of the following eight menu items.

### Help Topics

- Basic Operations
- Demo Songs
- Voices
- Styles
- Accompaniment
- Song Playback
- Song Recording
- Functions

- The selected menu is highlighted.
- Press the LCD button under ENTER to enter your selection.
- The first page of the selected help information is displayed.

## Using the Help Mode

### 4 Turn the pages and read the help information. ....

Use the fourth LCD button to advance the page. You can also press the third LCD button if you want to go back and read the previous page.



### 5 Exit the Help topic. ....

Press the LCD button under **EXIT** to return to the Help menu. You can select another menu item or panel button and read through other help topics.

### 6 Exit the Help mode. ....

To exit the Help mode and to go back to the main display at any time, simply press [**HELP**].

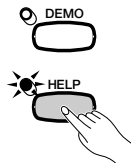

# CHAPTER 3: Voices



## Selecting Voices .....

The Clavinova features a wealth of rich, authentic voices, including piano, strings and brass instruments. It also features a Keyboard Percussion function that lets you play the realistic drum and percussion sounds directly from the keyboard.

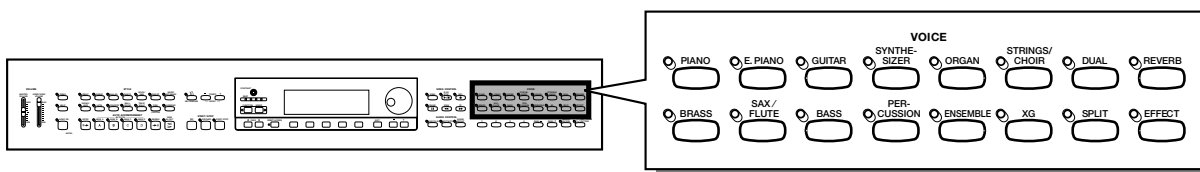

### ● Voice Types

- Clavinova Voices : 195
- XG Voices : 480
- Drum/SFX Kits : 12

\* For a list of the voices, see page 5 in the Reference Booklet.

\* The Clavinova's voices are divided into twelve groups, corresponding to the twelve VOICE buttons on the panel.

## Selecting a Voice from the VOICE SELECT Display

### 1 Select the voice group.....

Select the desired voice group by pressing the appropriate VOICE button.

→ The VOICE SELECT display appears.

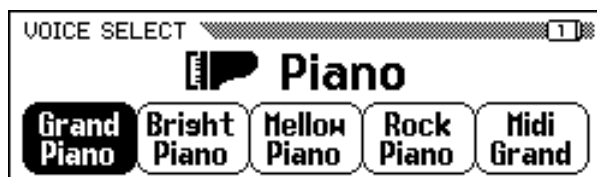
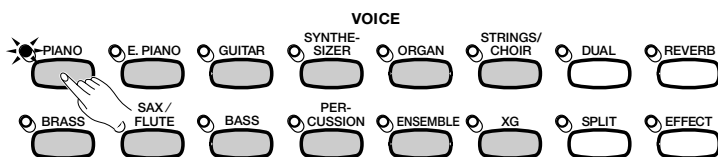

#### NOTE

##### Exiting the Display

To return to the main display, press [EXIT].

#### NOTE

##### Backing Up the Selected Voice

- When the power is turned ON, the Grand Piano voice is selected automatically. However, if the Backup function (page 152) is set to ON, the last selected voice will automatically be selected.
- The last selected voice in each group can be retained in memory, even after turning off the power, when the Backup function (page 152) is set to ON.

# Selecting Voices

## 2 Select the voice.....

Select the desired voice by pressing the appropriate LCD button. The data dial and [-] and [+] buttons can be also used.

Each VOICE SELECT display consists of two or more pages. Use the PAGE [◀] and [▶] buttons to call up the various pages.

## 3 Play the selected voice.....

Adjust the volume by using the [MASTER VOLUME] slider.

### NOTE

**Automatic Voice-related Settings**  
Selecting a voice automatically selects the best-suited reverb, chorus, effect, and other settings for that particular voice. You can disable this so that settings are not automatically selected by using the VOICE SETTING function (page 137).

# Selecting Voices from the Main Display

You can also select a voice using the **RIGHT1 VOICE** function in the main display.

## 1 Select the RIGHT1 VOICE function.....

If the **RIGHT1 VOICE** function is not already highlighted, press the fourth LCD button to highlight it.

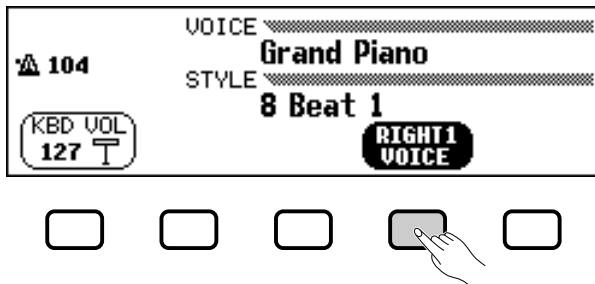

## 2 Select the voice.....

Select the voice using the data dial or [-] and [+] buttons. You can also hold down **RIGHT1 VOICE** to advance the voice selection continuously. (When selecting a voice in this way, the voice can be selected not only from a certain voice group but from all voices.)

## 3 Play the voice.....

Adjust the volume by using the [MASTER VOLUME] slider.

### NOTE

**About Ensemble Voices**  
The Clavinova's ensemble voices are rich, dual-like voices that you can play without entering the Dual mode (page 33.) Press the [Ensemble] button to display a menu of ensemble voices.

### NOTE

**About XG Voices**  
Yamaha's XG format is a major new enhancement to the GM (General MIDI) System Level 1 format. It provides for more instrument sounds and variations, as well as greater expressive control over voices and effects. XG also ensures compatibility with future instruments and software.

- Press the [XG] button to display a menu of XG voices.
- Press another VOICE button while holding down the [XG] button to display a list of XG voices in the corresponding category.

## Keyboard Percussion

The Clavinova has ten drum kits and two SFX kits, found on pages 3 and 5 of the [PERCUSSION] voice group. When one of the drum or SFX kits is selected, various drum, percussion, and special effect sounds are assigned to individual keys, letting you play the sounds from the keyboard.

The various drums and percussion instruments of the **Standard Kit** are indicated by symbols above the assigned keys.

See the drum/SFX kit list on page 10 in the Reference Booklet for a listing of the sounds in each drum/SFX kit.

**NOTE**

- When a drum kit is selected, only the keys with drum or percussion symbols printed above them will sound.
- When an SFX kit is selected, keys other than those which have been assigned a special effect sound will not produce any sound.
- The Transpose (page 136), Tune (page 136) and Octave (pages 32,34 and 38) functions do not affect the drum/SFX kits.

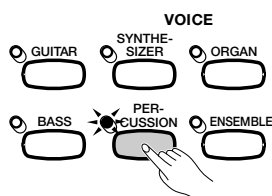

## Changing the Keyboard Settings for the Main Voice

You can use the settings in the KEYBOARD [RIGHT1] display page to change the volume, octave, and pan of the voice selected using the **RIGHT1 VOICE** function.

**NOTE**

The settings you make in this page affect any voices you select using the **RIGHT1 VOICE** function. Different settings cannot be made for each voice.

### ■ Displaying the Main Voice Keyboard Settings .....

- 1 If you are playing in Dual mode or Split mode, make sure **RIGHT1 VOICE** is selected in the main display.
- 2 Press [**DIRECT ACCESS**] followed by any of the **VOICE** buttons.
  - ➔ The **KEYBOARD [RIGHT1]** display appears.

**NOTE**

You can switch between the **KEYBOARD [RIGHT1]** page and the [RIGHT2] (page 34) or [LEFT] (page 37) displays using the **PAGE** [◀] and [▶] buttons.

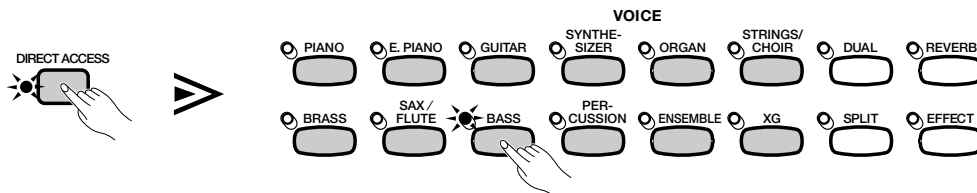

# Selecting Voices

## ■ Setting the Volume of the Main Voice .....

You can use the **VOLUME** function in the KEYBOARD [RIGHT1] page to change the volume of the main voice.

### 1 Press the **VOLUME** button.

→ The **VOLUME** function is highlighted.

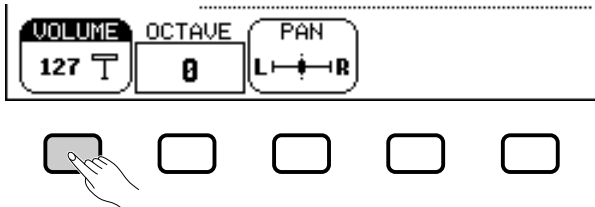

### 2 Adjust the volume of the main voice.

Use the data dial or [-] and [+] buttons to change the volume, or hold down the **VOLUME** button to increase the volume.

Press the [-] and [+] buttons simultaneously to restore the basic setting.

## ■ Setting the Octave of the Main Voice .....

The **OCTAVE** function in the KEYBOARD [RIGHT1] display lets you adjust the pitch of the main voice up or down by one or two octaves. Press the **OCTAVE** button.

→ The value changes each time you press the button.

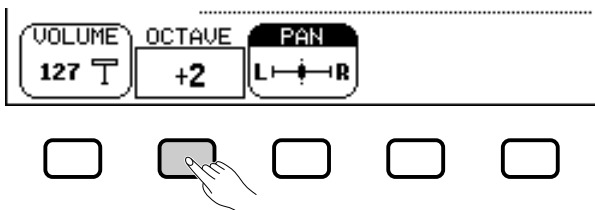

## ■ Setting the Stereo Position of the Main Voice .....

The **PAN** function in the KEYBOARD [RIGHT1] display lets you adjust the stereo position of the main voice.

### 1 Press the **PAN** button.

→ The **PAN** function is highlighted.

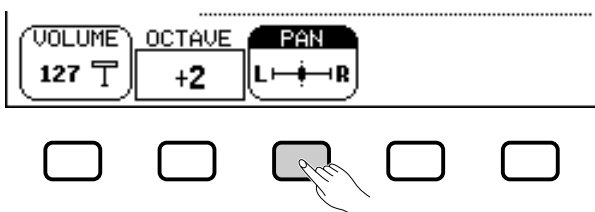

### 2 Adjust the stereo position.

Use the data dial or [-] and [+] buttons to change the stereo position, or hold down the **PAN** button to move the position to the right.

Press the [-] and [+] buttons simultaneously to restore the basic setting.

#### NOTE

To adjust the overall keyboard volume, use the KBD VOL function in the main display (page 23) instead.

#### NOTE

##### VOLUME

- Range: 0 — 127
- Basic setting: 127

#### NOTE

##### OCTAVE

- Settings: -2 (2 octaves lower)  
-1 (1 octave lower)  
0 (no octave shift)  
+1 (1 octave higher)  
+2 (2 octaves higher)
- Basic setting: 0

#### NOTE

Some voices have octave settings that are selected automatically when the voice is selected. (Such settings are not displayed by the OCTAVE function.) You can prevent the octave setting from changing when a voice is selected by setting the VOICE SETTING function (page 137) to MANUAL.

#### NOTE

##### PAN

- Settings: L — | — R
- Basic setting: | (center)





# Playing Two Voices Simultaneously — Dual Mode

The Dual mode of the Clavinova allows you to select and play two different voices simultaneously in a layer. This makes it easy to create exceptionally rich and thick tonal textures. You can also set the volume, octave, and stereo position for the second voice, and detune the second voice from the main voice to create a thicker sound.

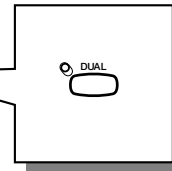
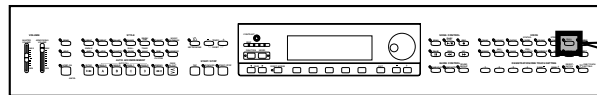

## Selecting the Second Voice

### 1 Select the main voice.

Select a voice in the normal way (page 29), then press [EXIT] to return to the main display.

### 2 Call up the Dual mode.

To call up the Dual mode, press the [DUAL] button.

➔ The **RIGHT2 VOICE** function appears in the lower right corner of the LCD display, and the current second voice is displayed to the right of the main voice (after the plus sign).

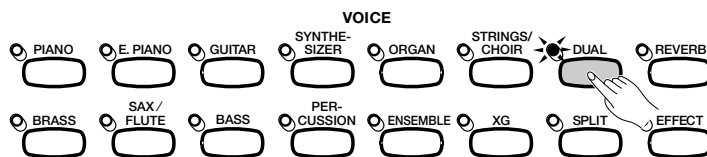

### 3 Select the second voice.

Select the second voice in the same manner as described for the main voice (page 29). To select the second voice, the **RIGHT2 VOICE** function must be highlighted.



#### Second Voice

- Range: All voices
- Basic setting: StringsSlow

## Changing the Main Voice in Dual Mode

To change the main voice while playing in Dual mode, select the **RIGHT1 VOICE** function then select the main voice in the normal manner.



If you use the VOICE buttons to select a voice while either the tempo or the KBD VOL function is highlighted, the voice you select will be used as the main voice.

## Changing the Keyboard Settings for the Second Voice

You can use the settings in the **KEYBOARD [RIGHT2]** display page to change the volume, octave, pan and detune of the voice selected using the **RIGHT2 VOICE** function.

### ■ Displaying the Second Voice Keyboard Settings .....

Press **[DIRECT ACCESS]**, then **[DUAL]**.

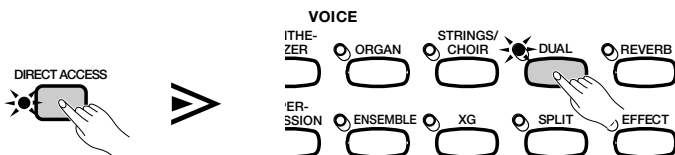

→ The **KEYBOARD [RIGHT2]** display appears.

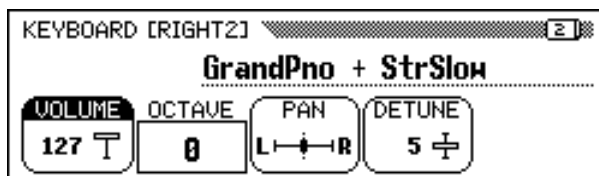

### ■ Setting the Volume of the Second Voice .....

You can use the **VOLUME** function in the **KEYBOARD [RIGHT2]** page to change the volume of the second voice.

#### 1 Press the **VOLUME** button.

→ The **VOLUME** function is highlighted.

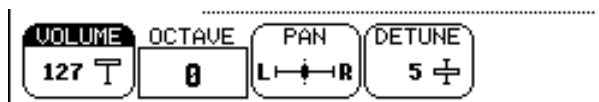

#### 2 Adjust the volume of the second voice.

Use the data dial or **[-]** and **[+]** buttons to change the volume, or hold down the **VOLUME** button to increase the volume.

Press the **[-]** and **[+]** buttons simultaneously to restore the basic setting.

### ■ Setting the Octave of the Second Voice .....

The **OCTAVE** function in the **KEYBOARD [RIGHT2]** display lets you adjust the pitch of the second voice up or down by one or two octaves. Press the **OCTAVE** button.

→ The value changes each time you press the button.

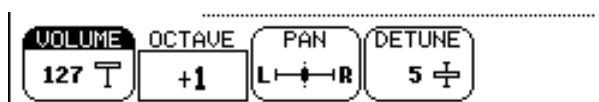

#### NOTE

The settings you make in this page affect any voices you select using the **RIGHT2 VOICE** function. Different settings cannot be made for each voice.

#### NOTE

If the **RIGHT2 VOICE** function is selected in the main display, you can also display the **KEYBOARD [RIGHT2]** page by pressing **[DIRECT ACCESS]** followed by any one of the **VOICE** buttons.

#### NOTE

You can switch between the **KEYBOARD [RIGHT2]** page and the **[RIGHT1]** (page 31) or **[LEFT]** (page 37) displays using the **PAGE** **[◀]** and **[▶]** buttons.

#### NOTE

To adjust the overall keyboard volume, use the **KBD VOL** function in the main display (page 23) instead.

#### NOTE

- VOLUME**
- Range: 0 — 127
  - Basic setting: 127

#### NOTE

- OCTAVE**
- Settings: -2 (2 octaves lower)
  - 1 (1 octave lower)
  - 0 (no octave shift)
  - +1 (1 octave higher)
  - +2 (2 octaves higher)
  - Basic setting: 0

#### NOTE

Some voices have octave settings that are selected automatically when the voice is selected. (Such settings are not displayed by the **OCTAVE** function.) You can prevent the octave setting from changing when a voice is selected by setting the **VOICE SETTING** function (page 137) to **MANUAL**.

## ■ Setting the Stereo Position of the Second Voice .....

The **PAN** function in the KEYBOARD [RIGHT2] display lets you adjust the stereo position of the second voice.

### 1 Press the **PAN** button.

→ The **PAN** function is highlighted.

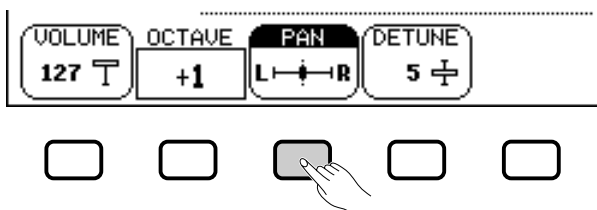

### 2 Adjust the stereo position.

Use the data dial or [-] and [+] buttons to change the stereo position, or hold down the **PAN** button to move the position to the right.

Press the [-] and [+] buttons simultaneously to restore the basic setting.



#### PAN

- Settings: L — R
- Basic setting: (center)

## ■ Detuning the Second Voice .....

The **DETUNE** function in the KEYBOARD [RIGHT2] display page lets you detune the pitch of the second voice slightly from that of the main voice, to produce an even richer sound.

### 1 Press the **DETUNE** button.

→ The **DETUNE** function is highlighted.

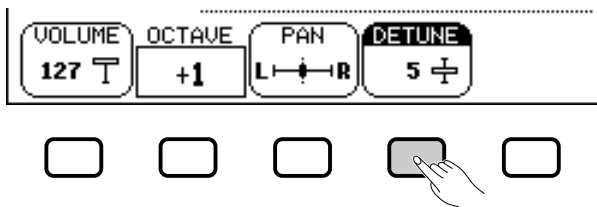

### 2 Adjust the detune depth.

Use the data dial or [-] and [+] buttons to change the detune depth, or hold down the **DETUNE** button to increase the detune depth.

Press the [-] and [+] buttons simultaneously to restore the basic setting.



#### DETUNE

- Range: 0 — 10
- Basic setting: 5

## Exiting the Dual Mode

Press the **[DUAL]** button to exit Dual mode.

→ The **[DUAL]** button lamp turns off, and the keyboard no longer plays in Dual mode.

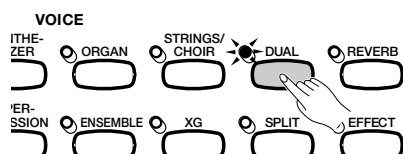

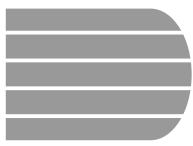

# Playing Two Voices on Different Sides of the Keyboard — Split Mode.....

The Split mode of the Clavinova allows you to select and play two different voices with each hand. For example, you can play the bass with your left hand and the piano with your right hand.

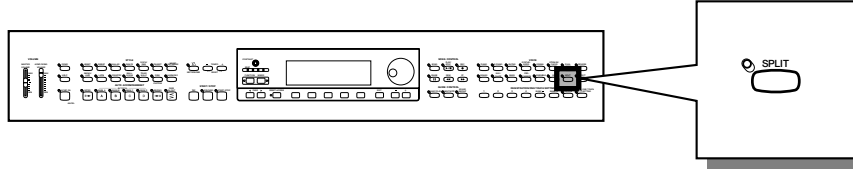

## Selecting the Left Voice

### 1 Select the main voice.

Select a voice in the normal way (page 29), then press [EXIT] to return to the main display. The voice you select will be played by the right range of the keyboard.

### 2 Call up the Split mode.

To call up the Split mode, press the [SPLIT] button.

- ➔ The **LEFT VOICE** function appears in the bottom center of the LCD display, and the current left voice is displayed to the left of the main voice (before the slash). Also, the keyboard guide lamp corresponding to the split point lights.

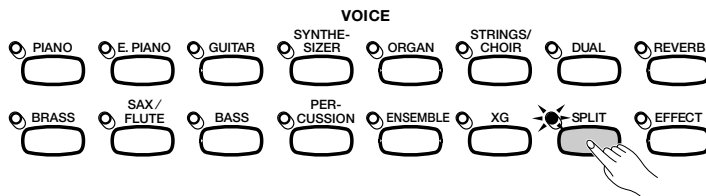

### 3 Select the left voice.

Select the left voice in the same manner as described for the main voice (page 29). To select the left voice, the **LEFT VOICE** function must be highlighted.

**NOTE**

#### Split point

The split point is the key that divides the right and left sides of the keyboard. You can change the split point using the **SPLIT POINT** function in the **KEYBOARD [LEFT]** display page (page 39).

**NOTE**

You can use the Single Finger, Multi Finger, Fingered1, or Fingered2 modes (page 59) of the Automatic Accompaniment function while playing in Split mode. In this case, pressing the keys in the left range will play the Automatic Accompaniment voices as well as the left voice.

**NOTE**

#### Left Voice

- Range: All voices
- Basic setting: Acous.Bass 1

## Changing the Main Voice in Split Mode

To change the main voice while playing in Split mode, select the **RIGHT1 VOICE** function then select the main voice in the normal manner.



**NOTE**

If you use the **VOICE** buttons to select a voice while either the tempo or the **KBD VOL** function is highlighted, the voice you select will be used as the main voice.

## Changing the Keyboard Settings for the Left Voice

You can use the settings in the **KEYBOARD [LEFT]** display page to change the volume, octave, and pan of the voice selected using the **LEFT VOICE** function. You can also select the keyboard range that is affected by the pedals, as well as the split point that separates the right and left ranges, using the functions in this page.

### ■ Displaying the Left Voice Keyboard Settings .....

Press **[DIRECT ACCESS]**, then **[SPLIT]**.

→ The **KEYBOARD [LEFT]** display appears.

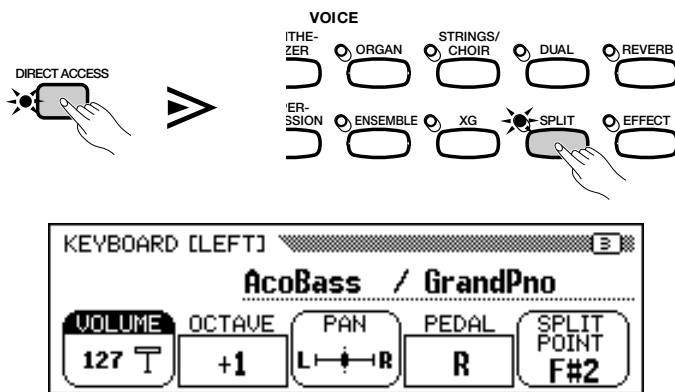

### ■ Setting the Volume of the Left Voice .....

You can use the **VOLUME** function in the **KEYBOARD [LEFT]** page to change the volume of the left voice.

#### 1 Press the **VOLUME** button.

→ The **VOLUME** function is highlighted.

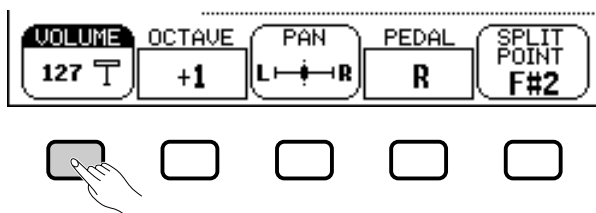

#### 2 Adjust the volume of the left voice.

Use the data dial or **[-]** and **[+]** buttons to change the volume, or hold down the **VOLUME** button to increase the volume.

Press the **[-]** and **[+]** buttons simultaneously to restore the basic setting.

#### NOTE

The settings you make in this page affect any voices you select using the **LEFT VOICE** function. Different settings cannot be made for each voice.

#### NOTE

If the **LEFT VOICE** function is selected in the main display, you can also display the **KEYBOARD [LEFT]** page by pressing **[DIRECT ACCESS]** followed by any one of the **VOICE** buttons.

#### NOTE

You can switch between the **KEYBOARD [LEFT]** page and the **[RIGHT1]** (page 31) or **[RIGHT2]** (page 34) displays using the **PAGE [◀]** and **[▶]** buttons.

#### NOTE

To adjust the overall keyboard volume, use the **KBD VOL** function in the main display (page 23) instead.

#### NOTE

**VOLUME**

- Range: 0 — 127
- Basic setting: 127

# Playing Two Voices on Different Sides of the Keyboard — Split Mode .....

## ■ Setting the Octave of the Left Voice .....

The **OCTAVE** function in the KEYBOARD [LEFT] display lets you adjust the pitch of the left voice up or down by one or two octaves. Press the **OCTAVE** button.

→ The value changes each time you press the button.

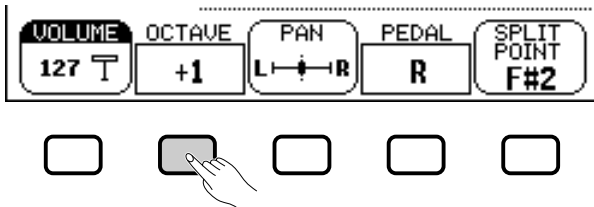

## ■ Setting the Stereo Position of the Left Voice .....

The **PAN** function in the KEYBOARD [LEFT] display lets you adjust the stereo position of the left voice.

### 1 Press the **PAN** button.

→ The **PAN** function is highlighted.

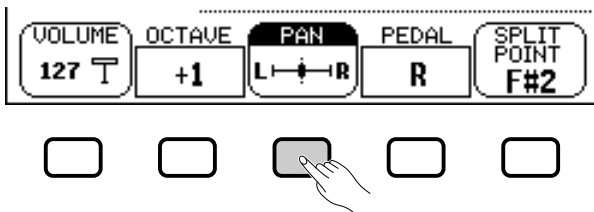

### 2 Adjust the stereo position.

Use the data dial or [-] and [+] buttons to change the stereo position, or hold down the **PAN** button to move the position to the right.

Press the [-] and [+] buttons simultaneously to restore the basic setting.

## ■ Setting the Range Affected by the Right and Left Pedals .....

The **PEDAL** function in the KEYBOARD [LEFT] display lets you specify which ranges of the keyboard will be affected by the damper and glide functions controlled by the left and right pedals when playing in Split mode. Press the **PEDAL** button.

→ The value changes each time you press the button.

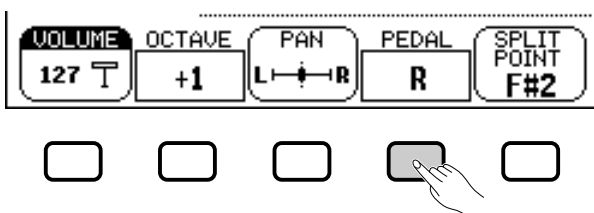

### NOTE

#### OCTAVE

- Settings: -2 (2 octaves lower)  
-1 (1 octave lower)  
0 (no octave shift)  
+1 (1 octave higher)  
+2 (2 octaves higher)
- Basic setting: +1

### NOTE

Some voices have octave settings that are selected automatically when the voice is selected. (Such settings are not displayed by the OCTAVE function.) You can prevent the octave setting from changing when a voice is selected by setting the VOICE SETTING function (page 137) to MANUAL.

### NOTE

#### PAN

- Settings: L — | — R
- Basic setting: | (center)

### NOTE

#### PEDAL

- Settings: R (right only)  
L (left only)  
L+R (both)
- Basic setting: R

### NOTE

See page 138 for a list of the functions that can be controlled by the left pedal.

# Playing Two Voices on Different Sides of the Keyboard — Split Mode

## ■ Changing the Split Point

You can use the **SPLIT POINT** function in the **KEYBOARD [LEFT]** display to set the split point at any desired key position. In Split mode, the left voice is played by all keys to the left of (and including) the split point.

The basic setting of the Split Point is F#2.

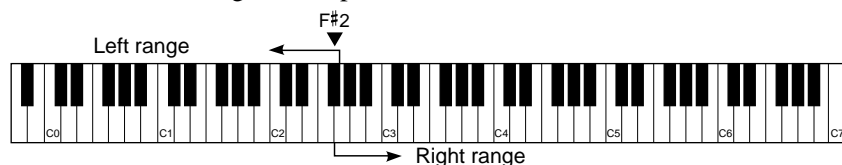

### 1 Press the **SPLIT POINT** button.

→ The **SPLIT** function is highlighted.

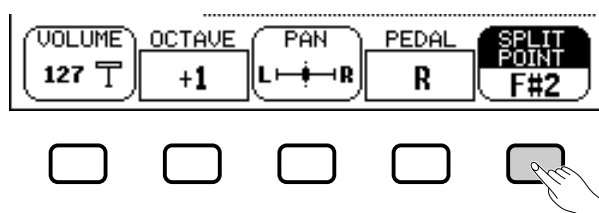

### 2 Change the split point.

Use the data dial or [-] and [+] buttons to change the split point, or hold down the **SPLIT POINT** button to move the split point to the right.

Press the [-] and [+] buttons simultaneously to restore the basic setting.

→ The keyboard guide lamp corresponding to the selected Split Point lights, and the key name is displayed by the **SPLIT POINT** function.

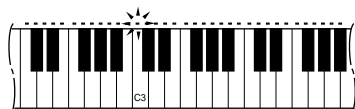

#### NOTE

#### SPLIT POINT

- Settings: Any key of the keyboard
- Basic setting: F#2

## Using the Dual and Split Functions Simultaneously

The **[DUAL]** and **[SPLIT]** buttons can be turned on simultaneously. When you do so, the right range of the keyboard will play both the main voice and the second voice.

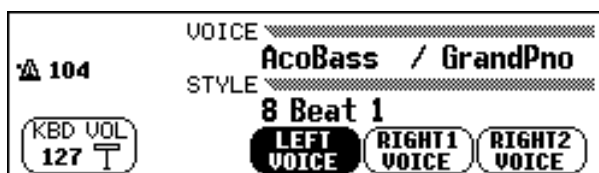

#### NOTE

When both the Dual and Split modes are turned on, the name of either the second voice or the left voice will be displayed together with the main voice in the main display.

## Exiting the Split Mode

Press the **[SPLIT]** button to exit Split mode.

→ The **[SPLIT]** button lamp turns off, and the keyboard no longer plays in Split mode.

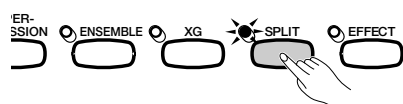



# Using the Pedals.....

The Clavinova has three pedals.

## Damper Pedal (Right)

The damper pedal performs the same function as the damper pedal on an actual acoustic piano, letting you sustain the sound of the voices even after releasing the keys.

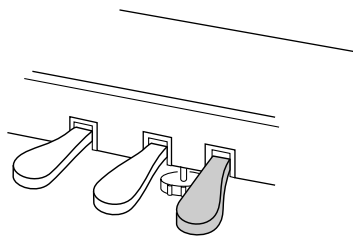

### NOTE

- Certain voices in the [PERCUSSION] and [XG] groups may not be affected by use of the damper pedal.
- Some voices may sound continuously or have a long decay after the notes have been released while the damper pedal is held.

## Sostenuto Pedal (Center)

If you play a note or chord on the keyboard and press the sostenuto pedal while the note(s) are held, those notes will be sustained as long as the pedal is held, but all subsequently played notes will not be sustained. This makes it possible to sustain a chord, for example, while other notes are played staccato.

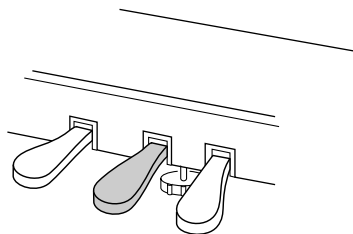

### NOTE

- Certain voices in the [PERCUSSION] and [XG] groups may not be affected by use of the sostenuto pedal.
- Certain voices, such as [STRINGS] or [BRASS], sustain continuously when the sostenuto pedal is pressed.

## Soft Pedal (Left)

Pressing this pedal reduces the volume and slightly changes the timbre of the notes you play.

You can also assign one of many other functions to this pedal; for example, you can use it to start/stop the Automatic Accompaniment, or use it to play Fill Ins. See page 138 for details.

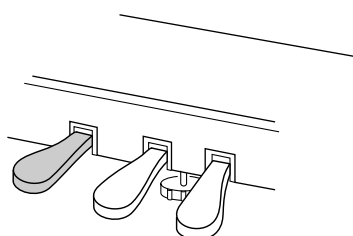

### NOTE

The effect of the soft pedal may differ slightly depending on the selected voice.



# CHAPTER 4: Reverb and Other Effects



## Reverb .....

Reverb is an effect that recreates the acoustic ambiance of a performance space — anything from a room in a jazz club to a concert hall. The Clavinova lets you choose from a variety of reverb effects; you can also set the depth of any reverb effect to your preference.

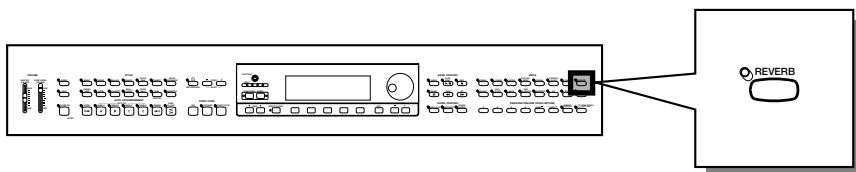

### Turning the Reverb On or Off

To apply reverb to the keyboard part(s), press the **[REVERB]** button.

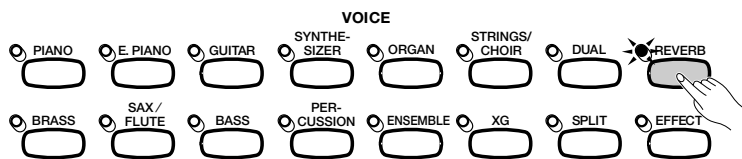

→ The lamp lights.

To turn the reverb off, press **[REVERB]** again.

→ The lamp turns off.

Because the basic setting of the **[REVERB]** button depends on the voice, the reverb may turn on or off automatically when you select a different voice.



**Reverb ON/OFF**  
Basic setting: Depends on voice.



The setting of the **[REVERB]** button has no effect on Song mode or Auto Accompaniment playback.

### Changing the Reverb Settings

You can change the reverb type and depth using the REVERB and REVERB DEPTH display pages.

#### ■ Displaying the Reverb Settings .....

1 Press **[DIRECT ACCESS]**, then **[REVERB]**.

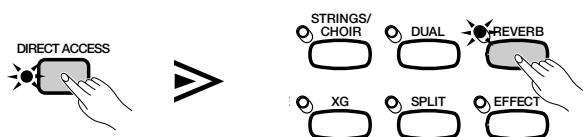

- The LCD displays either the REVERB page or the REVERB DEPTH page (whichever was selected most recently).

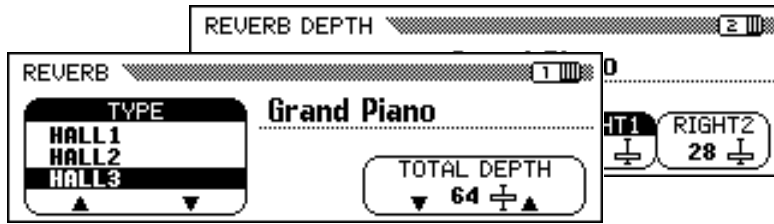

- Use the PAGE [◀] and [▶] buttons to switch between the REVERB page and the REVERB DEPTH page.

## ■ Changing the Reverb Type

You can change the reverb type using the REVERB display. Use the **TYPE** ▲ and ▼ buttons to change the reverb type, or select the **TYPE** function and use the data dial or the [-] and [+] buttons.

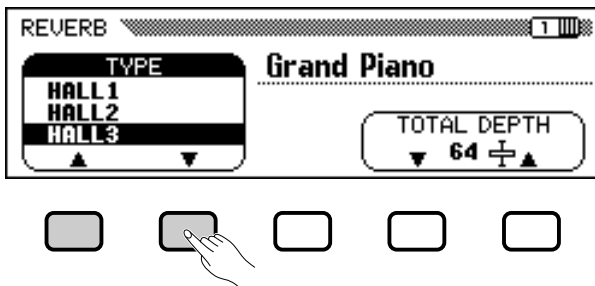

- The selected reverb type is highlighted.

Because the basic setting of the reverb type depends on the accompaniment style, the reverb type may change automatically when you select a different style.

## ■ Setting the Total Depth

The overall depth of the selected reverb effect can be set using the **TOTAL DEPTH** function in the REVERB display.

- Select the **TOTAL DEPTH** function.

- The **TOTAL DEPTH** function is highlighted.

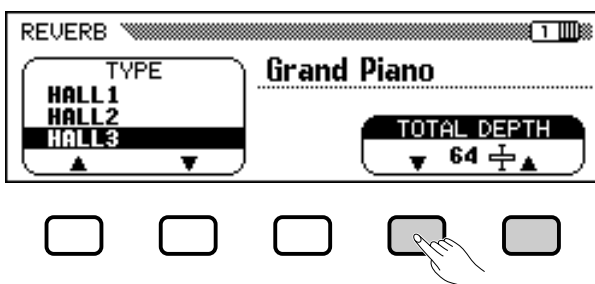

### NOTE

If you press the [▶] button while the REVERB DEPTH page is showing, the CHORUS page will be displayed. Refer to the other sections of this chapter for details on chorus and other effect settings.

### NOTE

#### Reverb Type

- Settings: See table on page 162.
- Basic setting: Depends on style.

### NOTE

- The reverb type selection affects all voices played by the keyboard or Auto Accompaniment. Different settings cannot be made for each part.
- Depending on the selected voice, the depth of the effect may sound stronger or weaker, even though the same reverb type is selected.
- The reverb effect cannot be applied to the sounds input through the AUX IN [R] and [L+R] jacks.
- It is also possible to apply reverb effects to the keyboard voices using the [EFFECT] button. See the Effect Type List on page 46 for details.
- If both the [REVERB] and [EFFECT] buttons are turned on, both effects will be applied.

### NOTE

#### TOTAL DEPTH

- Range: 0 (no effect) — 127 (max.)
- Basic setting: 64

## 2 Set the total depth of the reverb effect.

You can change the setting using the **TOTAL DEPTH** ▼ and ▲ buttons, the data dial, or the [-] and [+] buttons.

To reset the value to the basic setting of **64**, simultaneously press either the **TOTAL DEPTH** ▼ and ▲ buttons or the [-] and [+] buttons.

## ■ Setting the Reverb Depth for Each Part.....

The settings in the REVERB DEPTH display (page 42) let you set the reverb depth separately for the rhythm and accompaniment parts, as well as the parts you play from the keyboard.

### 1 Select a part.

Press the LCD button corresponding to **RHYTHM** to set the reverb depth for the drum part, or **ACMP** to set it for all other accompaniment parts. Select **LEFT**, **RIGHT1**, or **RIGHT2** to set the reverb depth for the corresponding keyboard part.

→ The selected function is highlighted.

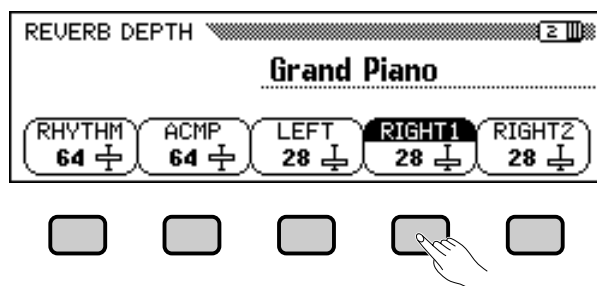

### 2 Set the reverb depth.

Set the reverb depth for the highlighted part by using the data dial or [-] and [+] buttons.

You can also advance a value by pressing the corresponding LCD button. To reset a value to its basic setting, simultaneously press the [-] and [+] buttons.

Because the basic settings of the **LEFT**, **RIGHT1**, and **RIGHT2** functions depend on the voices selected, a reverb depth setting may change automatically when you select a different part.

#### NOTE

- The **TOTAL DEPTH** setting globally affects all voices. Different settings cannot be made for each voice.
- You can also set the reverb depth separately for the rhythm and accompaniment parts, and for each keyboard part. (See the next operation.)

#### NOTE

- You can also select several parts at once and adjust their settings simultaneously.

#### NOTE

- RHYTHM and ACMP**
- Range: 0 (no effect) — 127 (max.)
  - Basic setting: 64

- LEFT, RIGHT1, and RIGHT2**
- Range: 0 (no effect) — 127 (max.)
  - Basic setting: Depends on voice.

#### NOTE

The amount of reverb that is applied to a part depends on both the part depth and **TOTAL DEPTH** settings. If one of the settings is 0, no reverb will be applied to that part even if the other setting is 127.

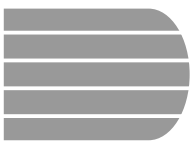

# Chorus

The Clavinova's chorus effects let you modify the voices you play from the keyboard, adding warmth for an even richer sound. Flanger effects add pronounced modulation, for a spacy futuristic quality. You can choose from a variety of chorus and flanger effects, and set the depth of the effect added to each keyboard voice.

## Changing the Chorus Settings

Unlike the reverb (page 41) and other effects (page 46), which can be turned on or off using the appropriate panel buttons, the chorus feature is always considered to be "on." How chorus is applied to any given voice depends on the current chorus type and depth settings. You can change these settings using the functions in the CHORUS display page.

### ■ Displaying the Chorus Settings

**1** Press [DIRECT ACCESS], then [REVERB].

→ The LCD displays either the REVERB page or the REVERB DEPTH page (whichever was selected most recently).

**2** Press the PAGE [▶] button once or twice, as needed.

Press PAGE [▶] twice if the REVERB page was displayed, or once if the REVERB DEPTH page was displayed.

→ The CHORUS page is displayed.

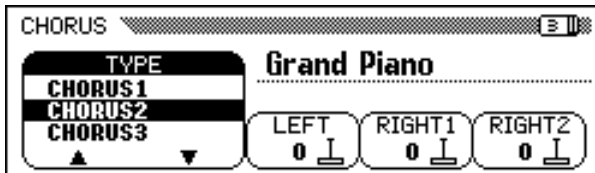

### ■ Changing the Chorus Type

You can change the chorus type selection in the CHORUS page.

Use the **CHORUS** ▲ and ▼ buttons to change the chorus type, or select the **CHORUS** function and use the data dial or the [-] and [+] buttons.

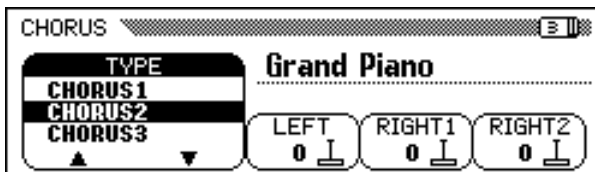

#### NOTE

The settings of the CHORUS display have no effect on Song mode or Auto Accompaniment playback.

#### NOTE

- You can also press [DIRECT ACCESS] followed by [EFFECT], then use the PAGE [◀] button to display the CHORUS page from either the EFFECT page or the EFFECT DEPTH page.
- Refer to the other sections of this chapter for details on reverb and other effect settings.

#### NOTE

##### Chorus Type

- Settings: See table on page 162.
- Basic setting: Depends on style.

→ The selected chorus type is highlighted.

Because the basic setting of the chorus type depends on the accompaniment style, the chorus type may change automatically when you select a different style.

## ■ Setting the Chorus Depth for Each Part .....

The other settings in the CHORUS page let you set the chorus depth separately for each part you play from the keyboard.

### 1 Select a part.

Press **LEFT**, **RIGHT1**, or **RIGHT2** to set the chorus depth for the corresponding keyboard part.

→ The selected function is highlighted.

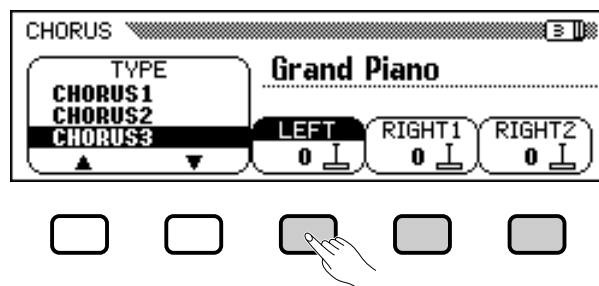

### 2 Set the chorus depth.

Set the chorus depth for the highlighted part by using the data dial or [-] and [+] buttons.

You can also advance a value by pressing the corresponding LCD button. To reset a value to its basic setting, simultaneously press the [-] and [+] buttons.

Because the basic settings of the chorus depth functions depend on the voices selected, a chorus depth setting may change automatically when you select a different voice.

#### NOTE

- The chorus type selection affects all keyboard parts. Different settings cannot be made for each part.
- Depending on the selected voice, the depth of the effect may sound stronger or weaker, even though the same chorus type is selected.
- It is also possible to apply chorus effects to the keyboard voices using the [EFFECT] button. See the Effect Type List on page 46 for details.

#### NOTE

You can also select several parts at once and adjust their settings simultaneously.

#### NOTE

##### Chorus Depth functions

- Range: 0 (no effect) — 127 (max.)
- Basic setting: Depends on voice.

#### NOTE

Since the chorus feature is always on, you should set a chorus depth of 0 for any parts that you don't want affected by the chorus effect.

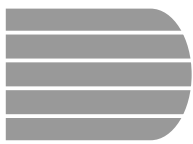

# Voice Effects.....

The Clavinova has a variety of effects besides reverb and chorus that you can use to enhance the sound of the voices or create wild, special effects. You can adjust the depth of the effect as desired.

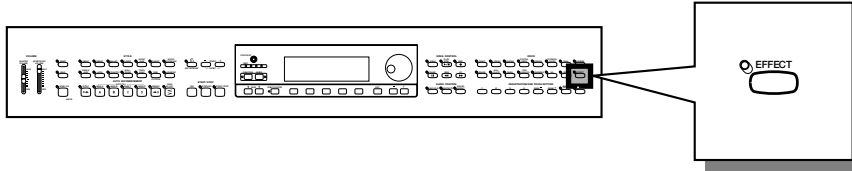

## Turning the Effects On

To apply the effect to the keyboard parts, press the [EFFECT] button.

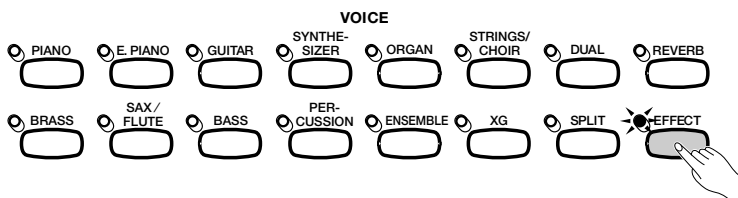

→ The lamp lights.

To turn the effect off, press [EFFECT] again.

→ The lamp turns off.

Because the basic setting of the [EFFECT] button depends on the voice, the effect may turn on or off automatically when you select a different voice.

**NOTE**

### Effect ON/OFF

Basic setting: Depends on voice.

**NOTE**

The [EFFECT] lamp will not light if the effect depth (page 48) is set to 0.

**NOTE**

When the effect system is also used by an accompaniment style or song, the effect being applied to the keyboard part(s) may automatically be turned off when you start the Auto Accompaniment or select the song for playback, depending on the effect type selected by the style or song. If this happens, you may be able to apply the effect to the keyboard part(s) by pressing the [EFFECT] button - again, this depends on the selected effect type. If you do so, the effect will not be applied to voices played by the Auto Accompaniment or song.

## Changing the Effect Settings

You can change the current effect type and depth using the EFFECT and EFFECT DEPTH display pages.

### ■ Displaying the Effect Settings.....

**1** Press [DIRECT ACCESS], then [EFFECT].

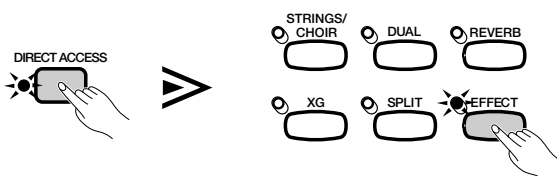

→ The LCD displays either the EFFECT page or the EFFECT DEPTH page (whichever was used most recently).



**NOTE**

If you press the [◀] button while the EFFECT page is showing, the CHORUS page will be displayed. Refer to the first two sections of this chapter for details on reverb and chorus settings.

2 Use the PAGE [◀] and [▶] buttons to switch between the EFFECT and EFFECT DEPTH pages.

### ■ Changing the Effect Type .....

You can change the effect type selection in the EFFECT page. Select an effect type using the **TYPE** ▲ and ▼ buttons, or highlight the **TYPE** function and use the data dial or the [-] and [+] buttons.

To reset the effect type to its basic setting, simultaneously press the **EFFECT TYPE** ▲ and ▼ buttons or the [-] and [+] buttons.

→ The selected effect type is highlighted.

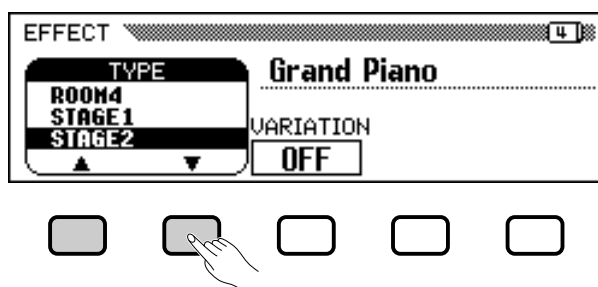

Because the basic setting of the effect type depends on the voice, the effect type may change automatically when you select a different voice.

### ■ Varying the Effect .....

Each of the Clavinova's effect types has a variation that can be selected using the **VARIATION** function in the EFFECT page. To vary the effect produced by the selected effect type, press the LCD button under **VARIATION**.

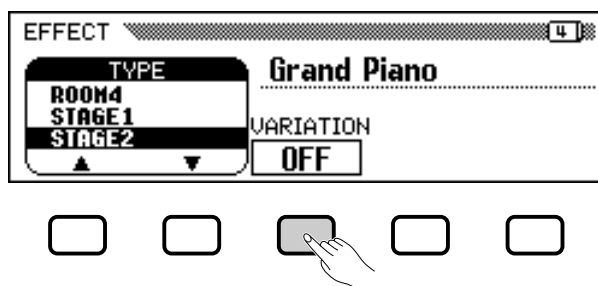

→ The value displayed by the **VARIATION** function switches between **OFF** and **ON**, and the effect changes.

The way in which the effect changes depends on the effect type (see the table on page 163). Also, because the basic setting of the **VARIATION** function depends on the voice, the setting of this function may change automatically when you select a different voice.

**NOTE**

**Effect Type**

- Settings: See table on page 163.
- Basic setting: Depends on voice.

**NOTE**

- The effect type selection affects all keyboard parts. Different settings cannot be made for each part.
- When the basic setting of the [EFFECT] button is ON for two or three voices selected in Dual and/or Split mode, the Clavinova will automatically select the most appropriate effect type and set the effect depth (page 48) for each part to an appropriate level.
- Depending on the selected voice, the depth of the effect may sound stronger or weaker, even though the same effect type is selected.
- If both the [EFFECT] and [REVERB] buttons are turned on, both effects will be applied.

**NOTE**

**VARIATION function**

- Settings: OFF, ON
- Basic setting: Depends on voice.

## ■ Setting the Effect Depth for Each Part .....

The settings in the EFFECT DEPTH page let you set the effect depth separately for each part you play from the keyboard.

### 1 Select a part.

Press **LEFT**, **RIGHT1**, or **RIGHT2** to set the effect depth for the corresponding keyboard part.

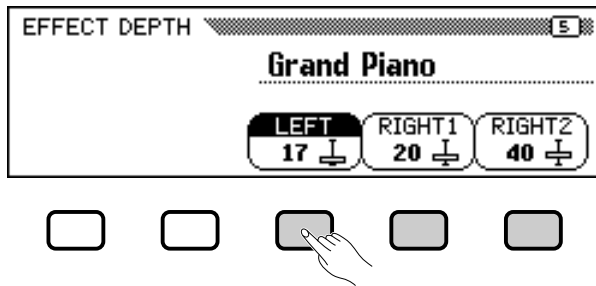

→ The selected function is highlighted.

### 2 Set the effect depth.

Set the effect depth for the highlighted part by using the data dial or [-] and [+] buttons.

You can also advance a value by pressing the corresponding LCD button. To reset a value to its basic setting, simultaneously press the [-] and [+] buttons.

Because the basic settings of the effect depth functions depend on the voices selected, an effect depth setting may change automatically when you select a different voice.

#### NOTE

##### **Effect Depth functions**

- Range: 0 (no effect) — 127 (max.)
- Basic setting: Depends on voice.



# CHAPTER 5: Accompaniment Styles

(Rhythm and Auto Accompaniment)

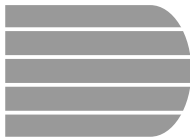

## Selecting Accompaniment Styles.....

The Clavinova has a wide variety of musical “styles” that you can use for simple percussion accompaniment, or as the basis of a fully orchestrated accompaniment — including bass and rhythm parts — using the Auto Accompaniment feature (page 57). There is also a selection of “Pianist” styles that let you play with piano accompaniment when you activate the Auto Accompaniment.

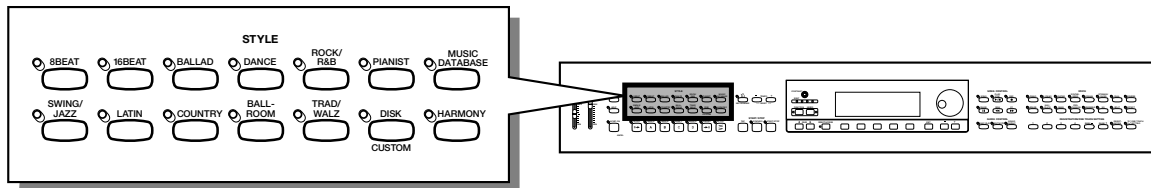

### ● Style Types

- Rhythm styles: 125
- Pianist styles: 35
- Custom styles: 4

- \* For information on the styles, see the Style List on page 12 in the Reference Booklet.
- \* The Clavinova's styles are divided into eleven groups, corresponding to the eleven STYLE buttons on the panel.
- \* The PIANIST styles and Guitar Waltz in the TRAD/WALTZ style group do not include drum sounds. Use the Auto Accompaniment (page 58) to play these styles.

## Selecting a Style

### 1 Select an accompaniment style group.....

Select the desired style group by pressing the appropriate STYLE button.

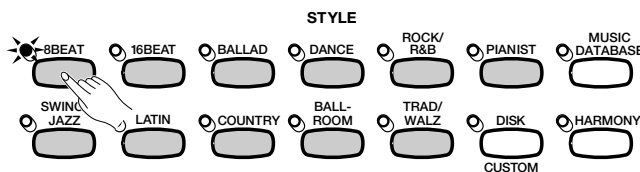

→ The corresponding STYLE SELECT display appears.



### NOTE

#### Disk and Custom Styles

The [DISK/CUSTOM] button lets you use styles on optional Style File Disks (page 86) or your original styles (page 73).

### NOTE

- The last selected style in each group can be retained in memory, even after turning off the power, when the Backup function (page 152) is set to ON.
- When the power is turned on, the 8 Beat 1 style is automatically selected. However, if the Backup function (page 152) is set to ON, the last selected style will be selected instead.
- Accompaniment styles cannot be selected in the Song Play mode page 93.

# Selecting Accompaniment Styles

## 2 Select a style.....

Select the desired style by pressing the appropriate LCD button.

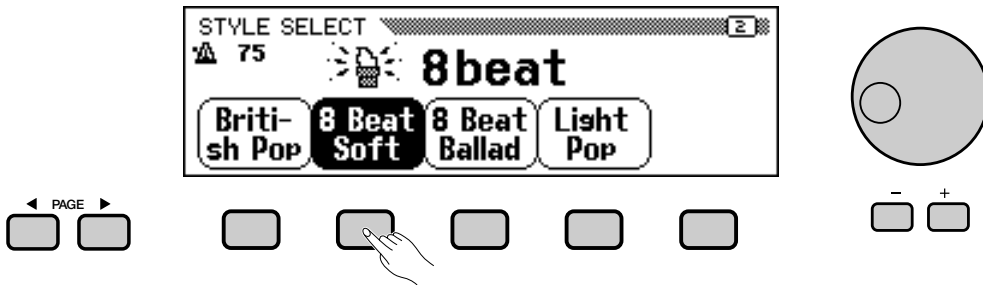

You can also select a style using the data dial or the [-] and [+] buttons.  
Each STYLE SELECT display consists of more than one page. Use the PAGE [◀] and [▶] buttons to switch between pages.

## 3 Return to the main display.....

Press [EXIT] to return to the main display.



### NOTE

#### Accompaniment Tempo

- Whenever you select a style, the preset tempo for that style is also selected (unless you change the style during playback, in which case the current tempo is maintained).
- Adjust the tempo as described on page 25.

### NOTE

#### Accompaniment Volume

Use the [ACMP/SONG VOLUME] slider to adjust the playback volume, as described on page 23.



# Playing the Accompaniment Styles .....

You will use the AUTO ACCOMPANIMENT buttons and the START/STOP buttons to select style variations and control style playback.

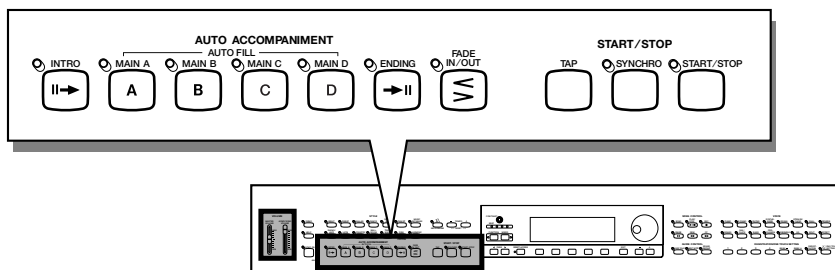

## Varying the Style

Each of the Clavinova's styles has four variations, corresponding to the AUTO ACCOMPANIMENT buttons labeled as [MAIN A], [MAIN B], [MAIN C], and [MAIN D].

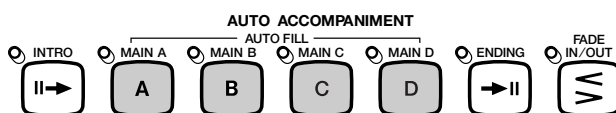

Use these buttons to select style variations.

Main A is generally the most rudimentary form of the style; the other variations are more or less lavish embellishments on the same basic theme. By judiciously switching between variations as you play, you can add variety and make the performance more interesting.

### Selecting a Variation .....

You can select a style variation before you start playing the style. To select a variation, simply press the corresponding button.

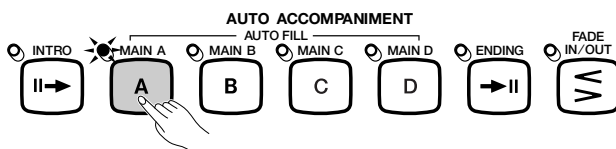

→ The button's lamp lights.

The Clavinova will begin playing the selected style variation when you start the style using one of the methods described in the next section.

### Playing Fill-in Patterns .....

If you select a different style variation while the style is playing, the Clavinova will play an automatic fill-in pattern as it switches to the new variation. The fill-in pattern, like the main pattern, is different for each variation.



#### Fill-in patterns

A "fill-in pattern" is an embellishment of the basic rhythm, usually played at the end of a musical phrase as an exciting transition into the next segment.

# Playing the Accompaniment Styles

To change the variation while the style is playing, press the button corresponding to the new variation.

➔ The button's lamp flashes as the Clavinova plays the fill-in pattern.

Generally speaking, the Clavinova will start the fill-in pattern soon after you press the button. If you select a variation after the last eighth note of a measure, however, it will begin the fill-in pattern from the start of the next measure.

➔ When the fill-in pattern is finished, the button's lamp lights steadily as the Clavinova plays the main pattern.

The auto fill-in feature provides an exciting transition as you switch from one variation to another. If Main A is playing and you press [MAIN B], for example, the Clavinova will play Fill-in B, then start playing Main B.

## More Fun With Fill-ins

### Changing the Fill-in

It is possible to switch variations while a fill-in pattern is playing. The Clavinova will switch to the fill-in pattern for the new variation, then continue with the new main pattern as usual.

### Repeating the Fill-in

If you hold down the flashing button, or press it after the last eighth note of the measure while the fill-in pattern is playing, the fill-in pattern will be repeated.

### Canceling the Fill-in

If you press the flashing button earlier than the last eighth note of the measure while the fill-in pattern is playing, the Clavinova will stop playing the fill-in pattern and continue with the main pattern.

NOTE

#### Using the Pedals

You can also use the left pedal to pause the style or play a special fill-in pattern by setting the LEFT PEDAL function (page 138) to BREAK or BREAK FIL.

NOTE

You can also play fill-in patterns without selecting a different variation. Just press the button for the variation that is playing. The Clavinova will play the fill-in for that variation, then return to the main pattern.

## Starting the Accompaniment Style

There are several ways to start the accompaniment style, as described below:

### Standard Start

This is the simplest way to start a style. If necessary, select a variation as described on page 51, then press the [START/STOP] button.

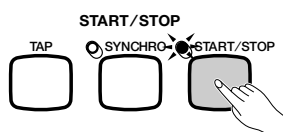

➔ The lamp lights and the style starts.

NOTE

#### Using the Pedals

You can also use the left pedal to start and stop the style by setting the LEFT PEDAL function (page 138) to START/STOP.

NOTE

#### Beat Indicator

During style playback, the leftmost beat lamp (red) flashes on the first beat of each measure, and the other lamps (green) flash for each successive beat. The current tempo and measure number are shown at the left edge of the main display.

## ■ Synchronized Start .....

This method lets you start the style by simply playing a note or chord on the keyboard.

### 1 Set the Synchronized Start function.

If necessary, select a variation as described on page 51, then press the [SYNCHRO] button.

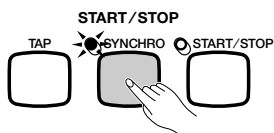

➔ The lamp lights, and the red [BEAT] lamp flashes in time with the current tempo.

### 2 Start playing.

When you are ready, play a note on the keyboard. The style starts playing when you play the first note.

➔ The [SYNCHRO] lamp turns off, the [START/STOP] lamp lights, and the style starts.

## ■ Tap Start .....

This function lets you set the tempo and start the style in one operation.

If necessary, select a variation as described on page 51, then tap the [TAP] button at the desired tempo. Tap four times for 2- and 4-beat styles, three times for 3-beat styles, and five times for 5-beat styles.

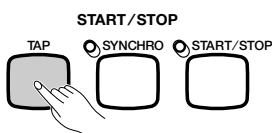

When playing a 4-beat style... ➤ Tap 4 times.

The [TAP] button can also be used to change the tempo during style playback (by tapping the button twice). In this case the tap “click” will not sound.

#### NOTE

- If the [SYNCHRO] button is pressed while a style is playing, style playback stops and Synchronized Start is automatically set to stand-by.
- When you play the keyboard in Split mode (page 36) or use the Auto Accompaniment in a mode other than FULL KEYBOARD (page 61), only the left-hand section of the keyboard will trigger a synchronized start.

#### NOTE

To cancel the Synchronized Start function before you start the style, press the [SYNCHRO] button again.

#### NOTE

If you do not tap the [TAP] button the required number of times (i.e., 3 times for a 3-beat style), the Tap Start function will be canceled after a few seconds.

# Playing the Accompaniment Styles

## ■ Adding an Introduction .....

This function lets you embellish the start of a tune by adding an introduction.

### 1 Set the introduction pattern.

Select the variation to play the intro pattern as described on page 51, then press the [INTRO] button. There are three introduction patterns, as shown below:

#### Intro Patterns

Pattern	Played by:
Intro A	[MAIN A]
Intro B	[MAIN B]
Intro C/D	[MAIN C] or [MAIN D]

➔ The [INTRO] lamp lights, and the lamp for the selected variation flashes.

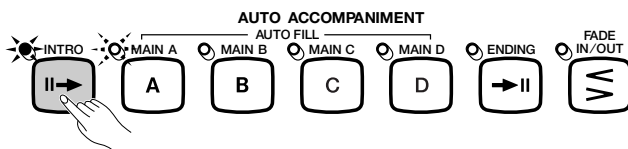

### 2 Select the main pattern.

Select the variation to play the main pattern when the intro is finished. (If you want the style to continue playing with the same variation as the introduction, you can skip this step.)

➔ The lamp for the previously selected button lights, and the lamp of the selected button flashes.

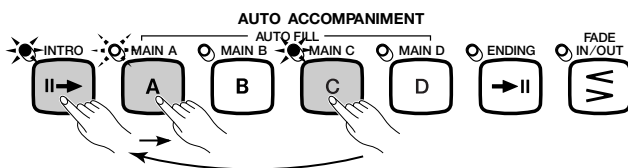

### 3 Start the style.

Use one of the three methods described on the preceding pages to start playing the style.

#### NOTE

The flashing light indicates the variation that will play after the intro. In the illustration at left, the Clavinova will play Intro A, followed by Main A.

#### NOTE

Since the flashing light indicates the variation that will play after the intro, the illustration at left indicates that the Clavinova will play Intro C/D, followed by Main A.

#### NOTE

To cancel the introduction before starting the style, press the [INTRO] button again.

## ■ Fading In .....

This function lets you gradually fade in the volume of the style. You can set the Fade In function at any time before you start the style, and use it in combination with any start method (including the Introduction function).

### 1 Press the [FADE IN/OUT] button.

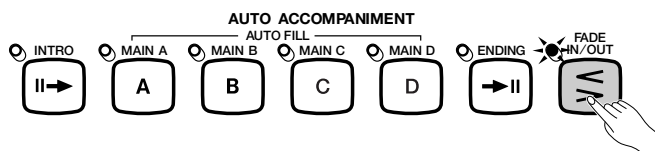

→ The lamp lights, and the Synchronized Start function (page 53) turns on automatically.

### 2 Start the style.

Use one of the three methods described on the preceding page to start playing the style.

→ The [FADE IN/OUT] lamp flashes during the fade-in, then turns off when the fade-in is completed.

#### NOTE

##### Using the Pedals

You can also use the left pedal to trigger a fade-in or fade-out by setting the LEFT PEDAL function (page 138) to FADE IN/OUT.

#### NOTE

To cancel the fade-in before starting the style, press the [FADE IN/OUT] button again.

## Stopping the Accompaniment Style

There are also several ways to stop accompaniment style playback, as described below:

## ■ Standard Stop .....

To stop style playback, press the [START/STOP] button.

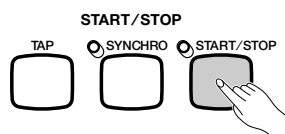

→ The lamp turns off and the style stops instantly.

## ■ Adding an Ending .....

To play an ending pattern before the style playback stops, press the [ENDING] button.

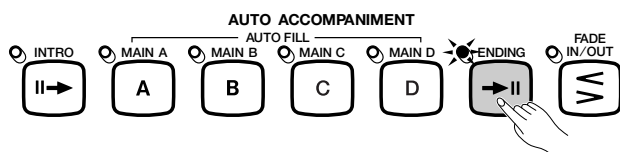

→ The ENDING lamp lights, and the Clavinova stops style playback after playing an ending pattern.

#### NOTE

##### Using the Pedals

You can also use the left pedal to start and stop the style by setting the LEFT PEDAL function (page 138) to START/STOP.

#### NOTE

If you press the [ENDING] button on or after the second beat of a measure, the ending pattern will start at the top of the next measure.

# Playing the Accompaniment Styles

The Clavinova will play one of three ending patterns, depending on the main pattern that is currently playing, as shown below.

## Ending Patterns

Pattern	Played by:
Ending A	[MAIN A]
Ending B	[MAIN B]
Ending C/D	[MAIN C] or [MAIN D]

Press **[ENDING]** a second time while the ending pattern is playing to produce a ritardando (gradually slowing) effect.

## ■ Fading Out

You can have the style fade out and automatically stop by pressing the **[FADE IN/OUT]** button.

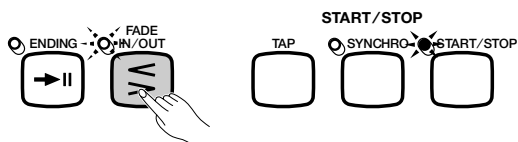

→ The lamp flashes as the style fades out.

You can use the Fade Out function in combination with any pattern (including the Introduction and Ending functions).

### NOTE

#### Using the Pedals

You can also use the left pedal to trigger the ending pattern and ritardando by setting the LEFT PEDAL function (page 138) to ENDING/RIT.

### NOTE

#### Using the Pedals

You can also use the left pedal to trigger a fade-in or fade-out by setting the LEFT PEDAL function (page 138) to FADE IN/OUT.





# Playing with the Auto Accompaniment . . . .

The Clavinova includes a sophisticated Auto Accompaniment system that can provide automated rhythm, bass and chord backing for your performance in 125 different styles, as well as 35 different types of piano-only accompaniment.



*The Auto Accompaniment playback data is normally not output by the MIDI [OUT] terminal. To send the Auto Accompaniment data to another MIDI instrument, use the ACMP&RHY and HARMONY functions in the FUNCTION [MIDI 4] display described on page 150.*

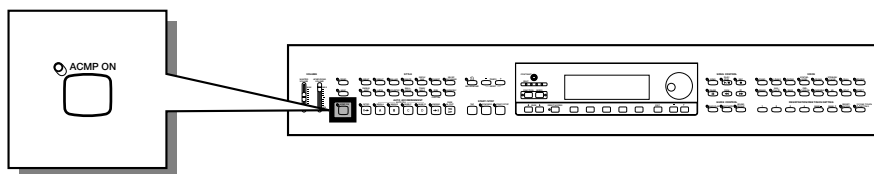

## Using the Auto Accompaniment

You can use one of several methods to indicate the chords that are to be played by the Auto Accompaniment. Choose the accompaniment mode that best suits your playing style.

### ● Single Finger

The Single Finger method makes it easy to obtain accompaniment in major, seventh, minor, and minor-seventh chords by pressing certain keys (according to simple rules) to the left of the split point indicated by the keyboard guide lamp. (See page 60.)

### ● Multi Finger

When you select the Multi Finger mode, you can use either the Single Finger method or the Fingered 1 method to indicate chords for the accompaniment. (See page 60.)

### ● Fingered 1

The Fingered 1 method lets you control the Auto Accompaniment by playing full chords to the left of the split point. (See page 60.)

### ● Fingered 2

This mode accepts the same fingerings as the Fingered 1 mode, with the exception that the lowest note played to the left of the split point is used as the bass root (in Fingered 1 mode, the root of the chord is always used as the bass root). Hence, you can select this mode to play “on bass” or “fraction” chords. (See page 61.)

### ● Full Keyboard

The Full Keyboard mode automatically produces appropriate automatic accompaniment for virtually anything you play, anywhere on the keyboard. (See page 61.)



*Detailed explanations of each accompaniment mode are given on pages 60 and 61.*

## Starting the Auto Accompaniment

You may want to select an accompaniment mode (page 59) before you start playing. If the accompaniment mode is set to your liking, you can start the Auto Accompaniment as follows:

### 1 Select a style.

Select the desired style. (See page 49.)

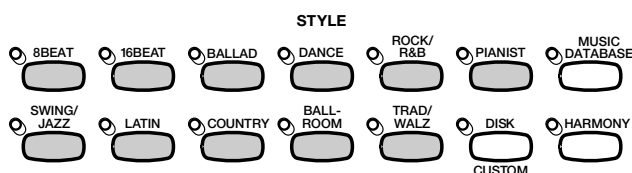

### 2 Set the tempo and accompaniment volume.

Use the TEMPO buttons to adjust the tempo (page 25), and the [ACMP/SONG VOLUME] slider to adjust the volume of the accompaniment parts (page 23).

### 3 Turn on the Auto Accompaniment.

Press the [ACMP ON] button.



→ The [ACMP ON] lamp lights.

The [SYNCHRO] lamp also lights, indicating that you can start the Auto Accompaniment with the Synchronized Start function (page 53). Also, a keyboard lamp shows the current split point.

### 4 Start the Auto Accompaniment.

Begin playing to start the Auto Accompaniment with the Synchronized Start function, or start the style using one (or more) of the other methods described on pages 52 and 55.

The methods used to indicate Auto Accompaniment chords are described in the following pages.

#### NOTE

##### Pianist styles

You can play the PIANIST styles and Guitar Waltz in the TRAD/WALTZ style group with the Auto Accompaniment (page 49). Since these styles do not contain drum parts, you'll have to indicate a chord as you start the style to hear the accompaniment.

#### NOTE

- The Auto Accompaniment will automatically turn on when you select a style in the Pianist style group.
- The Auto Accompaniment can also be turned on during playback of song data recorded on the CVP-109/107/105/103.
- If you turn the Auto Accompaniment on while playing back songs recorded using the Auto Accompaniment, the recorded accompaniment track will be dropped in favor of the accompaniment you play on the keyboard.

#### NOTE

- You can also select style variations and play fill-in patterns as described on page 51 while playing along with the Auto Accompaniment.
- Press the [ACMP ON] button again to turn the Auto Accompaniment off before you start playing.

## Stopping the Auto Accompaniment

Use one of the methods described on page 55 to stop playback of the style, including the Auto Accompaniment.

To turn Auto Accompaniment off, press the [ACMP ON] button so that the lamp goes out.

## Changing the Auto Accompaniment Settings

You can change the accompaniment mode (which selects the chord indication method), the split point, and other Auto Accompaniment settings in the ACCOMPANIMENT MODE display page.

### ■ Displaying the Auto Accompaniment Settings .....

Press [DIRECT ACCESS], then [ACMP ON].



→ The ACCOMPANIMENT MODE display appears.

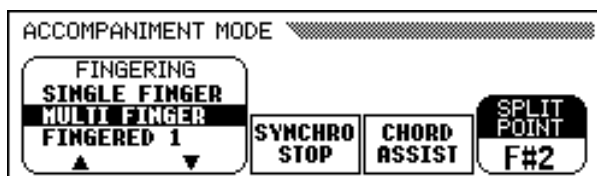

### ■ Selecting an Accompaniment Mode .....

Use the **FINGERING** ▲ and ▼ buttons to select an accompaniment mode.

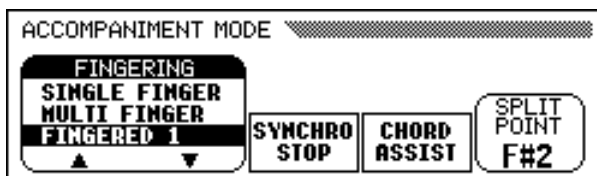

→ The selected accompaniment mode is highlighted.

The method for indicating chords in each accompaniment mode are described in detail below.

**NOTE**

**Accompaniment Mode**

- Settings: See insert below.
- Basic setting: MULTI FINGER

## Accompaniment Modes

### ● Single Finger

To control the Auto Accompaniment, press one, two, or three keys in the left range of the keyboard (below and including the split point), following the rules described below. Play the melody in the right range along with the Auto Accompaniment.

#### ■ Single Finger Chords

The following four chord types can be played in Single Finger mode:



- **Major**  
Press the root note of the chord.



- **Minor [m]**  
Simultaneously press the root note of the chord and any black key to the left of it.



- **Seventh [7]**  
Simultaneously press the root note of the chord and any white key to the left of it.

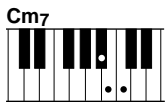

- **Minor Seventh [m7]**  
Simultaneously press the root note of the chord and any white and black keys to the left of it (three keys at once).

### ● Multi Finger

This method allows you to control the Auto Accompaniment using either the Single Finger method (described above) or the Fingered 1 method (described below). However, when indicating minor, seventh or minor seventh chords, it is necessary to play the white key and/or black key nearest the root note of the chord.

### ● Fingered 1

To control the Auto Accompaniment, play any chord in the left range of the keyboard (below and including the split point). Play the melody in the right range along with the Auto Accompaniment.

#### NOTE

- The Clavinova displays the names of the chords you play at the left edge of the main display, below the tempo.
- The same accompaniment continues (even after you release the chord in the left range) until you play the next chord.

#### NOTE

The illustration below shows the key corresponding to each root note.

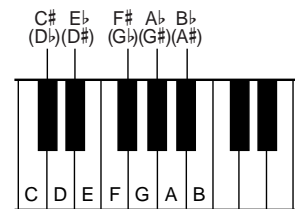

#### NOTE

- The automatic accompaniment will sometimes not change when related chords are played in sequence (e.g. some minor chords followed by the minor seventh).
- If the Clavinova cannot recognize a chord you play, an asterisk "\*" will appear instead of the chord name in the display.
- Drums-only accompaniment can be produced by pressing any three consecutive keys (e.g., C, C#, D) simultaneously. This lets you create dynamic "drum breaks" in the accompaniment. A series of dashes "-" will appear instead of a chord name in the display.

#### NOTE

Two-note fingerings will produce a chord based on the previously played chord.

## ■ Chords in Fingered 1 mode

The chord types below can be played in Fingered 1 mode. For a fingering chart showing all chords in the example key of C, see page 15 of the Reference Booklet.

- Major
- Sixth [6]
- Major seventh [M7]
- Major seventh flatted fifth [M7 (♭5)]
- Major seventh sharp eleventh [M7 (#11)]
- Added ninth [add 9]
- Major seventh ninth [M7 (9)]
- Six ninth [6 (9)]
- Flatted fifth [(♭5)]
- Augmented [aug]
- Seventh augmented [7 (#5)]
- Major seventh augmented [M7 (#5)]
- Minor [m]
- Minor sixth [m6]
- Minor seventh [m7]
- Minor seventh flatted fifth [m7 (♭5)]
- Minor added ninth [m add 9]
- Minor seventh ninth [m7 (9)]
- Minor seventh eleventh [m7 (11)]
- Minor major seventh flatted fifth [mM7 (♭5)]
- Minor major seventh [mM7]
- Minor major seventh ninth [mM7 (9)]
- Minor flatted fifth [m (♭5)]
- Diminished seventh [dim7]
- Seventh [7]
- Seventh suspended fourth [7sus4]
- Seventh ninth [7 (9)]
- Seventh sharp eleventh [7 (#11)]
- Seventh added thirteenth [7 (13)]
- Seventh flatted fifth [7 (♭5)]
- Seventh flatted ninth [7 (♭9)]
- Seventh added flatted thirteenth [7 (♭13)]
- Seventh sharp ninth [7 (#9)]
- Suspended fourth [sus4]

## ● Fingered 2

To control the Auto Accompaniment, play chords in the left range of the keyboard as for Fingered 1. In this mode, however, the lowest note you play in the will be used as the bass root, as shown at right.

### ■ Chords in Fingered 2 mode

The Clavinova will recognize the same chord types as listed above for Fingered 1 mode.

## ● Full Keyboard

When the Full Keyboard mode is selected, the Clavinova will automatically create appropriate accompaniment while you play just about anything using both hands, anywhere on the keyboard. You don't have to worry about specifying the accompaniment chords. The name of the detected chord will appear in the display.



### On-bass Chords

C



C on E



C on G



- Although Full Keyboard mode is designed to work with many types of music, some arrangements may not be suitable for use with this feature.
- Chord detection occurs at approximately 8th-note intervals. Extremely short chords — less than an 8th note in length — may not be detected.



**Keep in mind...**  
You can use the Dual and Split modes together with the Auto Accompaniment.

# Playing with the Auto Accompaniment

## ■ Using the Synchronized Stop Function .....

The **SYNCHRO STOP** function in the ACCOMPANIMENT MODE display automatically stops the Auto Accompaniment when you're not holding down any keys to the left of the split point.

Press the **SYNCHRO STOP** button to turn the function on.

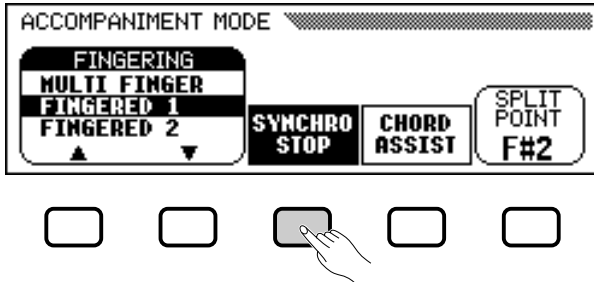

→ The **SYNCHRO STOP** function is highlighted, and the [SYNCHRO] lamp lights.

The Auto Accompaniment automatically starts when you play in the left range of the keyboard, and stops when you release it.

To turn the function off, press **SYNCHRO STOP** again.

## ■ Getting Help With Chords .....

The **CHORD ASSIST** function in the ACCOMPANIMENT MODE display uses the keyboard guide lamps to show you appropriate fingerings for chords.

### 1 Turn the Chord Assistance function on.

Press the **CHORD ASSIST** button.

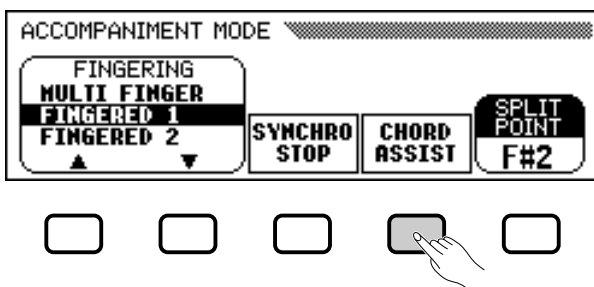

→ The CHORD ASSIST display appears, and the accompaniment mode automatically changes to Fingered 1.



### NOTE

This function can only be turned on if the Auto Accompaniment is on and Full Keyboard mode is not selected.

### NOTE

This is useful for beginning players who have difficulty playing in precise time. It is also effective for creating accompaniment "breaks" during the performance.

### NOTE

#### Chord Assistance

The Chord Assistance feature is essentially an electronic "chord book" that shows you appropriate fingerings for chords; it is useful when you want to quickly learn how to play certain chords. Simply specify the desired chord via the display, and the fingerings for the Fingered 1 method are indicated by the keyboard guide lamps.

### NOTE

- If the [ACMP ON] button is off, it will turn on.
- If the split point is set below F#2, it will automatically be reset to F#2.
- The keyboard guide lamps do not indicate the split point when Chord Assistance is on, since they are used to indicate chord fingerings instead.

## 2 Start the Auto Accompaniment.

Press [START/STOP] or use the Synchronized Start function (page 53) to start the Auto Accompaniment.

## 3 Enter the chord root.

Use the **ROOT** button to select a root.

→ The **ROOT** function is highlighted, and the root changes.

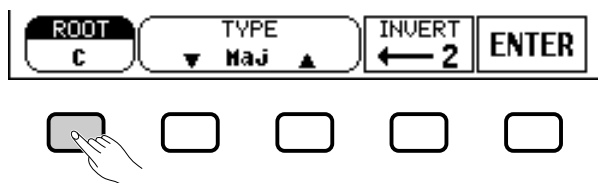

When the **ROOT** function is highlighted, you can also use the data dial or the [-] and [+] buttons to select a root.

## 4 Enter the chord type.

Use the **TYPE** ▼ and ▲ buttons to select a chord type.

→ The **TYPE** function is highlighted, and the type changes.

When the **TYPE** function is highlighted, you can also use the data dial or the [-] and [+] buttons to select a chord type.

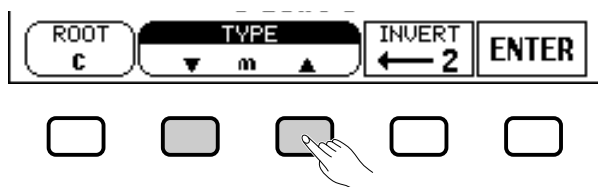

The following chord types can be specified in the display:

Major [Maj]	Augmented [aug]
Minor [m]	Minor flatted fifth [m (b5)]
Seventh [7]	Seventh suspended fourth [7sus4]
Minor seventh [m7]	Seventh augmented [7 (#5)]
Minor seventh flatted fifth [m7 (b5)]	Diminished seventh [dim7]
Sixth [6]	Flatted fifth [(b5)]
Minor sixth [m6]	Seventh flatted fifth [7 (b5)]
Major seventh [M7]	Minor major seventh [mM7]
Suspended fourth [sus4]	

## 5 Rotate the fingering as desired.

Press **INVERT** to shift the fingering down the keyboard. Each time the **INVERT** button is pressed, the next viable fingering for the chord appears. The **INVERT** function displays the inversion number.



### ROOT function

Settings: See sidebar on page 60.



If you hold the **ROOT** button down, the **INVERT** setting may also change.



### TYPE function

Settings: See list at left.

# Playing with the Auto Accompaniment

## 6 Enter the chord.

The keyboard guide lamps indicate the fingering for the selected chord. At this point you can either play the chord on the keyboard or press the **ENTER** button to hear the accompaniment play it.

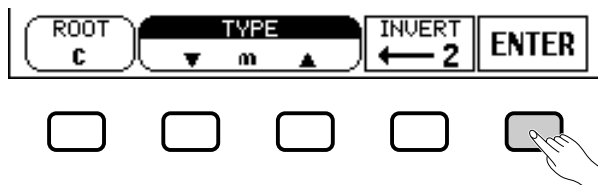

## 7 Stop the Auto Accompaniment.

When you're done with Chord Assistance, press **[START/STOP]** or **[ENDING]** to stop the accompaniment.

## 8 Turn Chord Assistance off.

To turn Chord Assistance off, press **[EXIT]** or **[ACMP ON]**.

➔ The main display appears. If you press **[ACMP ON]**, the Auto Accompaniment is turned off at the same time.

## Changing the Split Point

You can use the **SPLIT POINT** function in the ACCOMPANIMENT MODE display to set the split point at any desired key position. The keys to the left of (and including) the split point control the chords played by the Auto Accompaniment in every accompaniment mode except Full Keyboard.

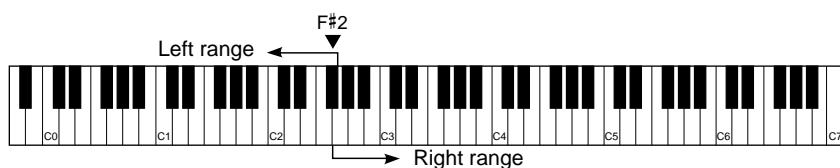

Use the data dial or the **[-]** and **[+]** buttons to change the split point. Press the **[-]** and **[+]** buttons simultaneously to restore the basic setting.

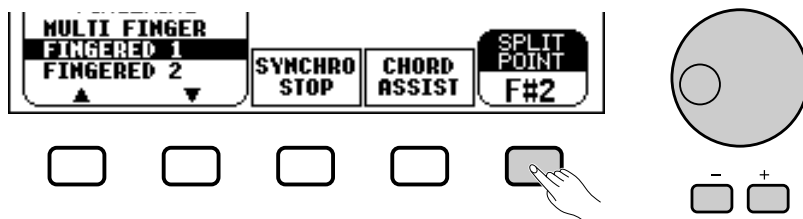

➔ The selected key name is displayed by the **SPLIT POINT** function.

If the Auto Accompaniment or the Split mode (page 36) is on, the keyboard guide lamp corresponding to the selected split point lights.

### NOTE

- Any chords recognized in Fingered 1 mode can be entered from the keyboard.
- The Clavinova displays the name of the chord recognized from the keyboard at the left edge of the LCD display, under the tempo. You can compare this chord root and type displayed by the ROOT and TYPE functions to make sure you're fingering the chord correctly. When the root of the chord being played corresponds to one of the black keys on the keyboard, the root may be displayed as either flat or sharp; for example, B $\flat$  may also be displayed as A# (see the sidebar on page 60 for details).
- A flashing keyboard guide lamp indicates a note which may be omitted.

### NOTE

#### SPLIT POINT function

- Settings: Any key of the keyboard
- Basic setting: F#2

### NOTE

- The split point cannot be set when Full Keyboard mode is selected.
- Changing the split point here also changes it for the Split mode (see page 39).



## Adjusting Individual Part Levels

The Clavinova has five accompaniment parts: Rhythm, Bass, Chord, Pad, and Phrase.

<b>RHYTHM</b>	This part forms the basis of the accompaniment. The Rhythm part usually plays one of the drum kits.
<b>BASS</b>	The Bass part uses voices appropriate to each style, including acoustic bass and synth bass.
<b>CHORD</b>	The Chord part provides appropriate rhythmic chordal accompaniment for each style. You'll find guitar, piano, and other chordal instruments here.
<b>PAD</b>	The Pad part plays long chords where necessary, using sustained instruments such as strings, organ, and choir.
<b>PHRASE</b>	The Phrase part is used for embellishments such as punchy brass stabs, arpeggiated chords, and other extras that make the accompaniment more interesting.

The volume settings for the five accompaniment parts can be adjusted individually in the MIXER display page.

### 1 Press the [MIXER] button.

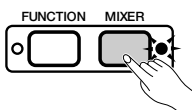

→ The lamp lights, and the MIXER page appears.



### 2 Select a part.

Press the LCD button for the part whose level you want to set.

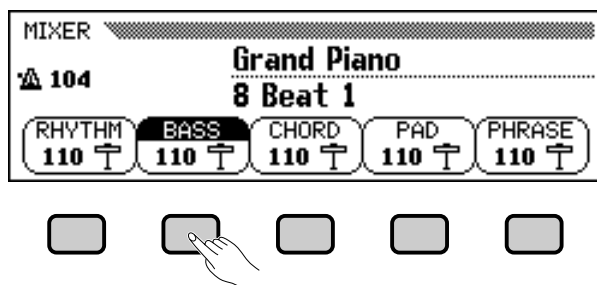

→ The selected function is highlighted.

#### NOTE

- The overall accompaniment playback volume can be adjusted using the [ACMP/SONG VOLUME] slider.
- By adjusting the volume balance of the various parts, or setting the volume of some parts to 0, you can create variations on the basic style accompaniment.
- Some styles may not use all five accompaniment parts.
- You can also adjust the level of reverb that is applied to the Auto Accompaniment parts. See page 43 for details.

#### NOTE

##### Part volume relationships

- The volume level of each Auto Accompaniment part is relative to the [ACMP/SONG VOLUME] setting.
- The [ACMP/SONG VOLUME] setting is relative to the [MASTER VOLUME] setting.

## 3 Set the volume level. ....

Use the data dial or [-] and [+] buttons to adjust the volume level. You can also increase the level by holding down the button you used to select the part.

You can set the volume of the highlighted part to **0** by pressing and quickly releasing its button. Press and release the button a second time to restore the previous value.

To reset the highlighted part's volume to the basic setting of **110**, simultaneously press the [-] and [+] buttons.

## 4 Repeat steps 2 and 3 . ....

Repeat the preceding steps to set the level for other parts. (You can also select several parts and adjust their volume settings simultaneously.)

## 5 Exit the MIXER display. ....

To exit the function, press the [MIXER] button again, or press [EXIT].

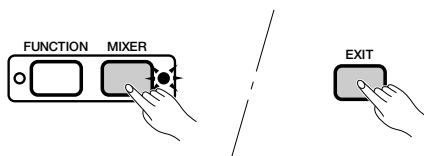

→ The lamp turns off, and the main display appears.

### NOTE

#### Part volume levels

- Range: 0 (min.) — 127 (max.)
- Basic setting: 110



# Other Auto Accompaniment Functions . . . .

The Clavinova has many other features and functions that make the use of the Auto Accompaniment even more convenient and enjoyable. With these functions you can easily select panel settings to suit a certain type of music, have the Clavinova play harmony to your melody line.

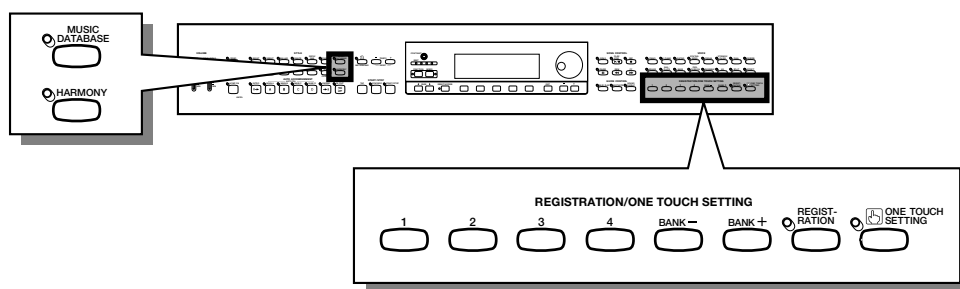

## Music Database

The Clavinova's built-in Music Database gives you a convenient way to select the style, voice, and effect settings that will suit a particular type of music. Just select one of the 463 entries in the Music Database; the Clavinova does the rest!

For a list of Music Database setup parameters, refer to page 13 of the Reference Booklet.

### 1 Display the Music Database.

Press the [MUSIC DATABASE] button.



→ The lamp lights, and the MUSIC DATABASE display appears.

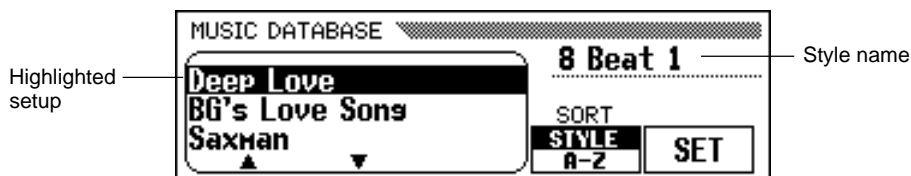

#### NOTE

- When you display the Music Database, the Clavinova automatically recalls a panel setup that uses the current style. (The name of this setup is highlighted in the Music Database display.) If you want to use the selected setup, you can simply skip to step 4 of this procedure.
- The Automatic Accompaniment also turns on when you display the Music Database. If you access the Music Database before starting the style, the Synchronized Start function (page 53) is also turned on.

The MUSIC DATABASE display contains a listing of panel setups that can be sorted either by style or alphabetically. The name of the style that is used by the currently highlighted setup is shown at the upper right edge of the display.

## Other Auto Accompaniment Functions

### 2 Sort the list, if necessary.

Press the **SORT** button to switch the highlighted setting between **STYLE** and **A-Z**.

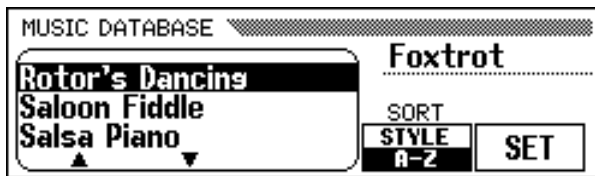

- When **STYLE** is highlighted, the menu list is sorted by style, and a panel setup that uses the currently selected style is highlighted.
- When **A-Z** is highlighted, the menu is sorted alphabetically.

### 3 Select and recall a panel setup.

Use the data dial or the [-] and [+] buttons to highlight the desired panel setup in the Music Database list, then press the **SET** button to recall the highlighted setup.

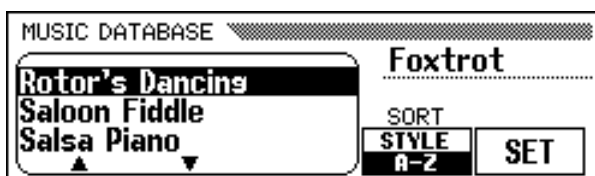

- The style, voice, and effect settings change automatically.

Once you have selected a panel setup from the Music Database, you can change the style, voice and effect settings to suit your preferences. You can also use the Registration function (page 89) to save the panel setup in the Clavinova's memory.

### 4 Return to the main display.

Press **[EXIT]** to exit the Music Database menu display.

- The previous display appears.

### 5 Turn off the Music Database.

When you're done using the Music Database setup, press the **[MUSIC DATABASE]** button again.

- The **[MUSIC DATABASE]** lamp turns off, and the panel settings you were using before you accessed the Music Database are restored.

#### NOTE

To display the panel setups for a specific style group, simply press the corresponding **STYLE** button. The menu is automatically sorted by style, and a panel setup that uses the currently selected style in the chosen group is highlighted.

#### NOTE

The Harmony function will not be turned on if the Full Keyboard mode is selected, even if the selected Music Database setup includes "Harmony On."

# Harmony

This feature adds harmony or embellishment notes to the melody you play using the main voice in the right range of the keyboard. The harmony notes are produced automatically to match chords played with Auto Accompaniment.

## ■ Adding Harmony .....

Since the Harmony function can be turned on and off while playing, you can add “spice” and professional polish to your performance by applying harmony to selected phrases as you play.

### 1 Turn the Harmony function on.

Press the [HARMONY] button.

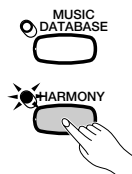

→ The lamp lights.

### 2 Play the keyboard.

Play the keyboard along with the Auto Accompaniment.

### 3 Turn the Harmony function off.

Press the [HARMONY] button again.

→ The lamp turns off.

## ■ Displaying the Harmony Settings .....

You can change the harmony type, the volume of the harmony voice, and other harmony settings in the HARMONY display page.

To display the HARMONY page, press [DIRECT ACCESS], then [HARMONY].

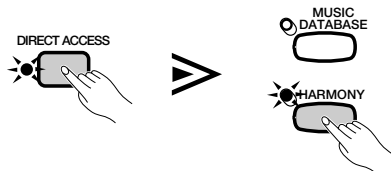

→ The HARMONY display appears.

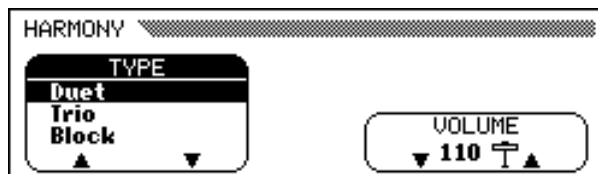

#### NOTE

- The Harmony feature cannot be turned on when Full Keyboard is selected as the accompaniment mode (page 59).
- The Harmony feature can be used while playing back the intro or ending, or while the Auto Accompaniment is off, if one of the following harmony types (page 70) is selected: Octave, 1+5, Echo, Tremolo, or Trill.

#### NOTE

- With some Harmony types the voice used for the Harmony will be different from the currently selected main voice.
- When chords are played in the right-hand section of the keyboard, the harmony will be applied to the last note played.

#### NOTE

##### Using the Pedals

- If you set the LEFT PEDAL function to HARMONY (page 138), the Clavinova will play harmony only while the left pedal is pressed.
- If you use the left pedal to control the harmony, that pedal will have no effect when the Harmony function is off (i.e., when the [HARMONY] lamp is not lit).

## Other Auto Accompaniment Functions

### ■ Selecting a Harmony Type .....

You can change the type of harmony that is played using the **TYPE** function in the HARMONY display.

Use the **TYPE** ▲ and ▼ buttons to select a harmony type, or select the **TYPE** function and use the data dial or [-] and [+] buttons.

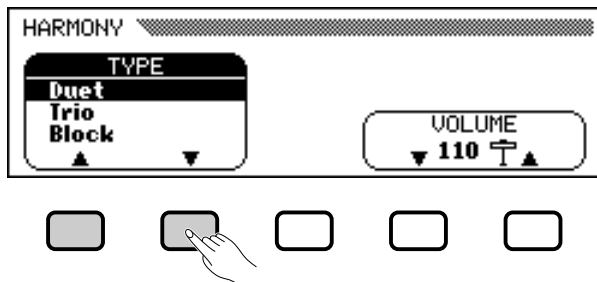

→ The selected harmony type is highlighted.

To restore the basic setting for the currently selected main voice, press the **TYPE** ▲ and ▼ buttons or the [-] and [+] buttons simultaneously.

Since the basic setting of the **TYPE** function depends on the currently selected main voice, a different harmony type may be selected automatically if you change the main voice selection.

#### Harmony Types

Type	Speed
Duet	—
Trio	—
Block	—
4 Part	—
Country	—
Octave	—
1+5	—
Echo	○
Tremolo	○
Trill	○
Strumming	—
Add Jazz Gtr	—
Add Brass	—
Add Strings	—
In The Forest	—

#### NOTE

##### TYPE function

- Settings: See table on this page.
- Basic setting: Depends on main voice.

#### NOTE

- Some harmony types (indicated by a "○" in the Speed column of the table at left) have a speed setting that can be adjusted. See the next topic for details.

## ■ Changing the Harmony Speed .....

You can change the speed of the harmony notes played by the **Echo**, **Tremolo**, and **Trill** harmony types using the **SPEED** function in the HARMONY display.

### 1 Select the **SPEED** function.

Press the LCD button under the **SPEED** function.

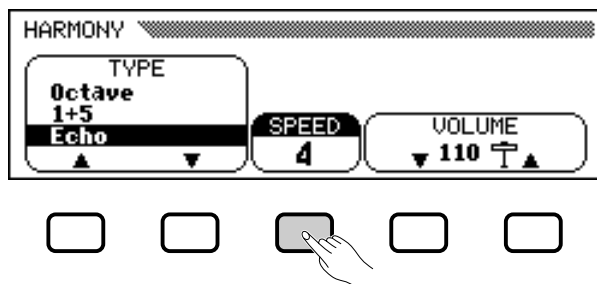

→ The **SPEED** function is highlighted.

### 2 Change the **SPEED** setting.

Use the **SPEED** button, the data dial, or the [-] and [+] buttons to change the value of the **SPEED** function.

## ■ Changing the Harmony Volume .....

You can change the volume of the harmony notes using the **VOLUME** function in the HARMONY display.

### 1 Select the **VOLUME** function.

Press the one of the LCD buttons under the **VOLUME** function.

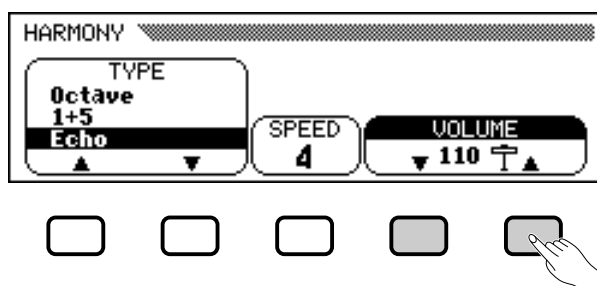

→ The **VOLUME** function is highlighted.

### 2 Change the **VOLUME** setting.

Use the **VOLUME** ▼ and ▲ buttons, the data dial, or the [-] and [+] buttons to change the value of the **VOLUME** function.

To restore the **VOLUME** function to its basic setting for the currently selected main voice, press the **VOLUME** ▼ and ▲ buttons or the [-] and [+] buttons simultaneously.

#### NOTE

##### **SPEED** function

- Settings: 4, 6, 8, 12 (Echo)  
8, 12, 16, 32 (Tremolo)  
12, 16, 24, 32 (Trill)
- Basic setting: Depends on main voice.

#### NOTE

##### **VOLUME** function

- Settings: 0 (min.) — 127 (max.)
- Basic setting: Depends on main voice.

## One Touch Setting

The Clavinova's convenient One Touch Setting function makes it easy for you to select voices and effects that are appropriate to the style you're playing. Each style has four preprogrammed panel setups that you can select by pressing a single button.

For a list of the One Touch Setting parameters, refer to page 13 of the Reference Booklet.

### 1 Select a style.....

Select the desired style in the normal way (see page 49).

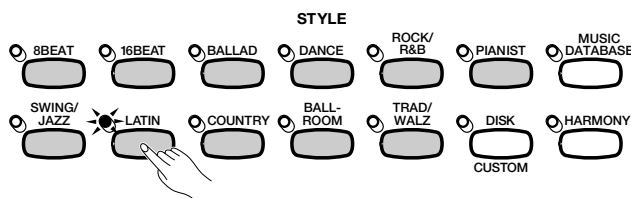

### 2 Make sure the ONE TOUCH SETTING function is on.

If necessary, press the [ONE TOUCH SETTING] button.

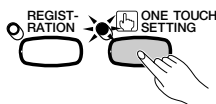

→ The [ONE TOUCH SETTING] button lamp lights.

### 3 Select a panel setup.....

Press one of the four numbered buttons under REGISTRATION/ONE TOUCH SETTING.

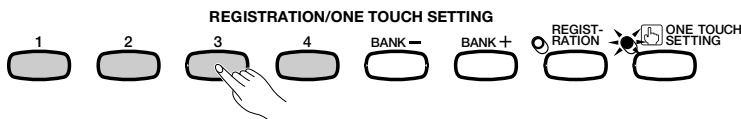

→ The voice and effect settings change automatically.

Once you have selected a panel setup using the One Touch Setting function, you can change the voice and effect settings to suit your preferences. You can also use the Registration function (page 89) to save the panel setup in the Clavinova's memory.

#### NOTE

The One Touch Setting function cannot be used with styles in the [DISK/CUSTOM] group.

#### NOTE

- When you select a panel setup, the Auto Accompaniment turns on automatically. If you select a panel setup before starting the style, the Synchronized Start function (page 53) will also turn on.
- The Harmony function will not be turned on if the Full Keyboard mode is selected, even if the selected One Touch Setting setup includes "Harmony On."





# Creating Your Own Styles.....

The Clavinova lets you create custom accompaniment styles that you can recall and play back at any time, just like the presets. Up to four custom styles can be maintained in the Clavinova's memory at the same time, and any number can be saved to disk for later reloading and use.

## Recording a Custom Style

Use the following procedure to record your own custom styles.

### 1 Select the DISK/CUSTOM style group.....

Press the [DISK/CUSTOM] button.

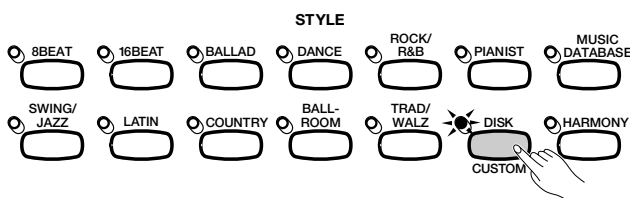

→ The lamp lights, and the DISK/CUSTOM STYLE display appears.

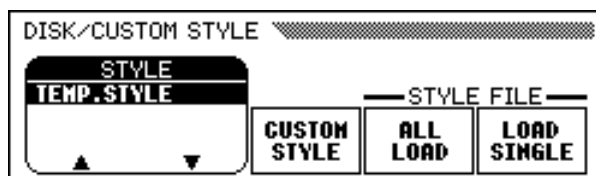

### 2 Select the CUSTOM STYLE function.....

Press the CUSTOM STYLE button.

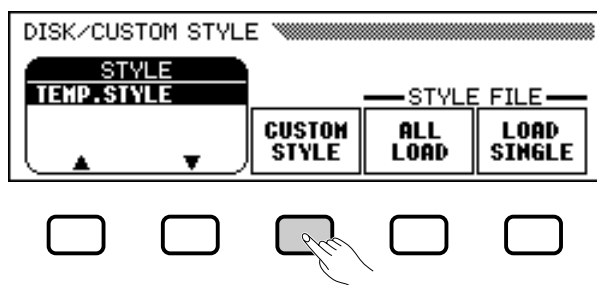

#### NOTE

- One temporary style (named TEMP.STYLE) is automatically loaded into the DISK/CUSTOM style memory when the power is turned on.
- If you have loaded other style data (see page 87), you can select any of the styles from the DISK/CUSTOM STYLE menu to serve as the basis for your new custom style.

# Creating Your Own Styles

- The “**Select a source style**” message is displayed for a few seconds, then replaced by page 1 of the CUSTOM STYLE display. The style that was selected in the DISK/CUSTOM STYLE display begins playing.

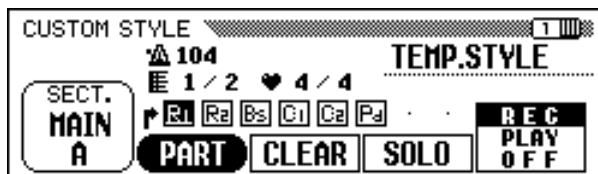

### 3 Select a source style.

Select a preset style that is close to the style you want to create. Preset style selection is carried out in the normal way (page 49).

You can also use the style already selected in the DISK/CUSTOM STYLE display as the basis for your new style, or select a different DISK/CUSTOM style just as you would a preset style.

### 4 Select the section you want to record.

In page 1 of the CUSTOM STYLE display, press the **SECT.** button as many times as necessary to display the section you want to record: MAIN A, MAIN B, MAIN C, MAIN D, INTRO, FILL IN, or ENDING.

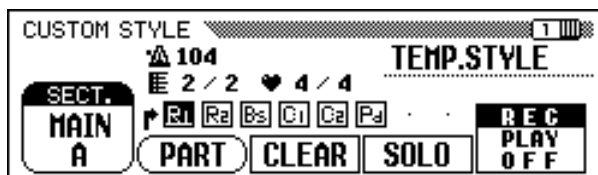

- The **SECT.** function is highlighted, and each section is displayed in turn. The Clavinova plays the currently displayed section repeatedly.

### 5 Change the beat and section length.

If you want to create a style with a different time signature than the selected style, or change the number of measures in the selected section, press the PAGE [▶] button.

- Page 2 of the CUSTOM STYLE display appears.

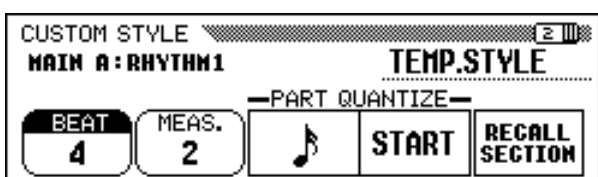

#### NOTE

- In the CUSTOM STYLE display, the variations and patterns that make up a style are referred to as “sections.”
- A custom style includes only one intro section, one fill-in section, and one ending section.
- The custom style’s intro, fill-in, and ending sections are based on the corresponding patterns for the style variation (MAIN A, MAIN B, MAIN C, or MAIN D) that was selected when the CUSTOM STYLE button was pressed (page 73).

## ● Changing the beat:

Press the **BEAT** button to select a different time signature.

→ The “Clear style?” message is displayed.

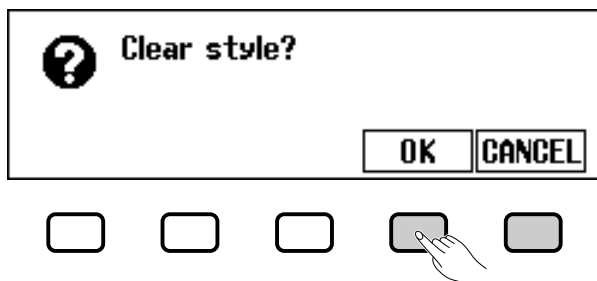

➤ Press **OK** to clear the style, or **CANCEL** to abort. Once the style has been cleared, you can use the **BEAT** button, the data dial, or the **[-]** and **[+]** buttons to select a new time signature.

## ● Changing the section length:

Press the **MEAS.** button to change the number of measures in the current section.

→ The “Clear section?” message is displayed.

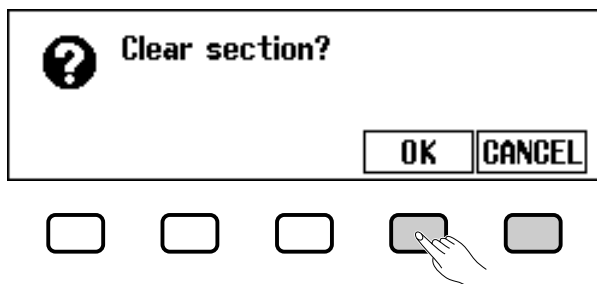

➤ Press **OK** to clear the section, or **CANCEL** to abort. Once the style has been cleared, you can use the **MEAS.** button, the data dial, or the **[-]** and **[+]** buttons to set the section length.

## ● When you're done here:

Once the **BEAT** and/or **MEAS.** parameters have been set as required, press the PAGE [**◀**] button to return to page 1 of the CUSTOM STYLE display.

### NOTE

#### BEAT function

- Settings: 2, 3, 4, 5
- Basic setting: Depends on style.

### NOTE

#### Clear style?

Since the patterns of the selected style will not match the new beat, you will have to completely clear the style and start recording from scratch if you change the time signature.

### NOTE

#### MEAS. function

- Settings: 1 — 8
- Basic setting: Depends on style.

### NOTE

#### Clear section?

- You will have to clear all parts of the currently selected section and start recording from scratch if you change the number of measures.
- The “Clear section?” message will not be displayed if you have already cleared the section by changing the beat, as described above.

### NOTE

The length of the FILL IN section can only be set to one measure.

# Creating Your Own Styles

## 6 Select the part you want to record.....

Use the **PART** LCD button, the data dial, or [-] and [+] buttons to select the part you want to record.

**NOTE**

The R1 part is initially selected and set to record.

R1	Rhythm 1
R2	Rhythm 2
Bs	Bass
C1	Chord 1
C2	Chord 2
Pd	Pad
P1	Phrase 1
P2	Phrase 2

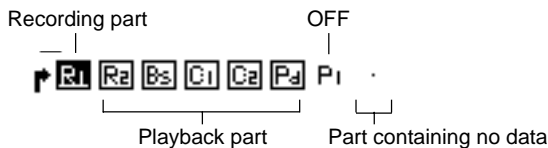
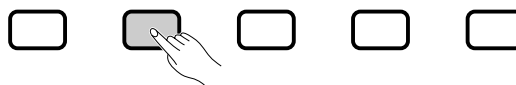
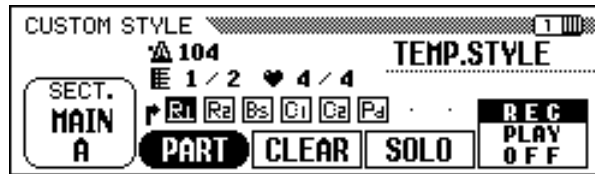

Any part you select can be set to record by using the rightmost LCD button to select **REC** after selecting the part.

- The part number is highlighted. If you have selected a part other than **R1** or **R2**, the “**Clear part?**” message will be displayed.

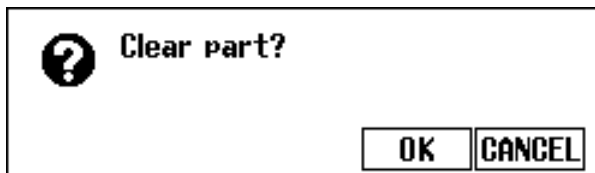

➤ Press **OK** to clear the part and continue, or **CANCEL** to abort.

**NOTE**

- Only one part can be set to record.
- All other parts will be set to **PLAY** (the part number is surrounded by a box) or **OFF** (only the part number is displayed).

**NOTE**

### Clear part?

- If the source style is a preset style or a style loaded from an optional Style File disk, parts other than R1 and R2 must be cleared before they can be re-recorded.
- The “Clear part?” message will not be displayed if the selected part does not contain any data.

## 7 Select the voice for the part. ....

At this point you can also select the voice you want to record the part with. Select the voice as you would the main keyboard voice (see page 29).

**NOTE**

The preset voice for the part being recorded is initially selected.

Part	Voices that can be used
R1	Any drum or SFX kit in PERCUSSION group
R2	Any
Others	Any except a drum kit or SFX kit

## 8 Record the selected part.....

You can now record new notes in the selected part by playing the keyboard at the appropriate timing. Record non-percussion parts in C major seventh (CM7), since the custom style is recorded as a C major seventh pattern.

If you want to create a totally new part from scratch, press the **CLEAR** LCD button to clear the selected part before beginning to record. If both the **R1** and **R2** parts are cleared, the metronome will sound to provide a timing guide. (The metronome sound is not recorded, and will stop as soon as the custom style is stored.)

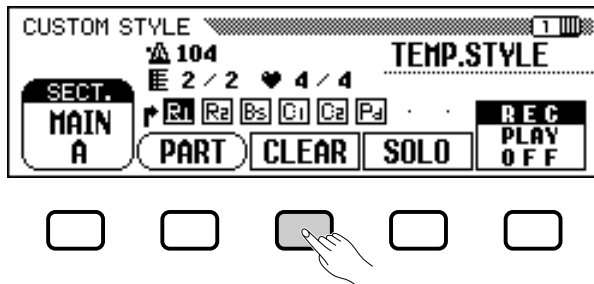

When recording a drum kit voice in part **R1** or **R2**, you can clear a single drum instrument from the part by pressing the key corresponding to the instrument to be cleared while holding down the C1 key on the keyboard. (The C1 key is labeled "CANCEL.") The metronome timing guide can also be cleared in this way.

Another useful recording aid is the **SOLO** LCD button: when this button is pressed and highlighted, only the selected part will sound. Press the **SOLO** button again to turn the solo function off and hear all parts in the selected section.

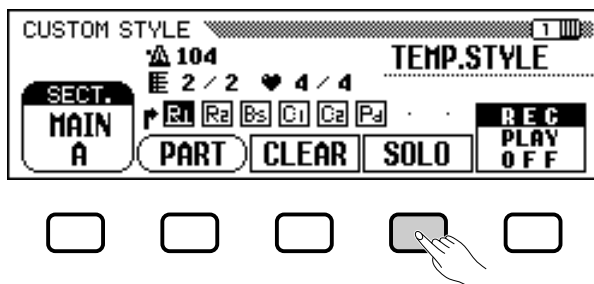

### NOTE

- Playback of the custom style can be started and stopped by pressing the [START/STOP] button. (Data cannot be recorded while playback is stopped.)
- All notes are automatically stopped at the end of the style (i.e., at the point between repeats when recording). It is therefore not advisable to record over this point.

# Creating Your Own Styles

## 9 Quantize the recorded part, if necessary.

You can “tighten up” the timing of a recorded part by using the **PART QUANTIZE** functions in page 2 of the CUSTOM STYLE display to align all the notes to a specified beat. Press the PAGE [▶] button to display the function, then press the middle LCD button to select the quantize size:

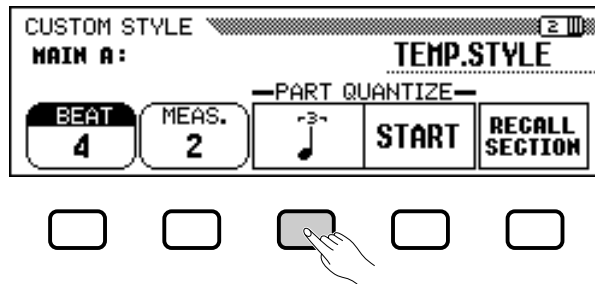
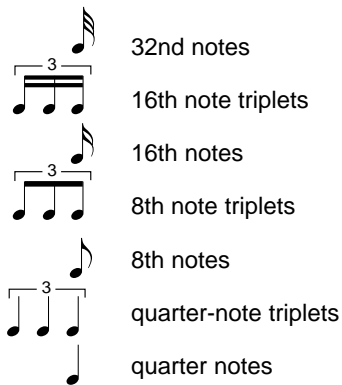

Once the required quantize size has been selected, press the **START** LCD button to quantize the current part. The part will begin to play using the new timing, and the **START** button will change to **UNDO**, allowing you to undo the quantize operation and return to the pre-quantized data if the results are not as you expected. You will not be able to **UNDO** once another button has been pressed.

## 10 Repeat until the custom style is complete.

Repeat steps 4 through 9 to record other parts for the currently selected section.

Repeat steps 4 through 10 to record other sections, until all sections have been recorded.

## 11 Name the custom style.

When your custom style is complete, use the PAGE buttons to select page 3 of the CUSTOM STYLE display, then press the **STYLE NAME** LCD button to display the NAME page.

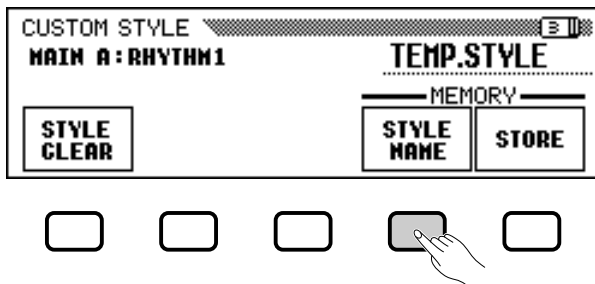

### NOTE

During custom style recording, no MIXER display is available.

Use the ► LCD button to position the underline cursor at the character you want to change (style names can be up to 12 characters in length). Use the data dial and/or the [-] and [+] buttons to select the character you want to enter from the list in the center of the display, then press the **CH.SET** LCD button to enter the character at the current cursor position. Repeat this procedure until your name is complete. The **BACK** LCD button can be used to back up one space and delete the preceding character.

When the name is complete, press **OK** to register the name for the current custom style, or **CANCEL** to abort.

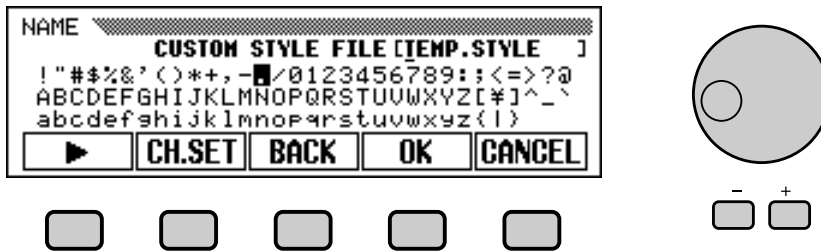

## 12 Store the custom style.

Press the **STORE** LCD button in page 3 of the CUSTOM STYLE display to store the current custom style in the Clavinova's memory.

### NOTE

The current tempo setting at the time the custom style is stored becomes the preset tempo for that style.

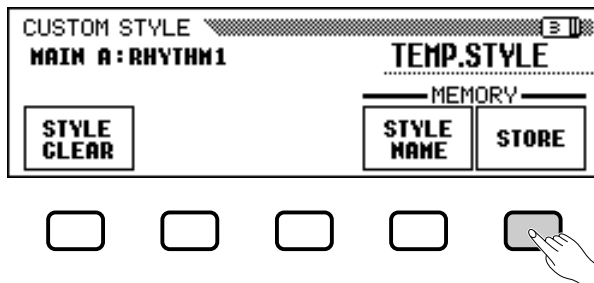

→ The Clavinova displays a message asking you to confirm your decision to store the style.

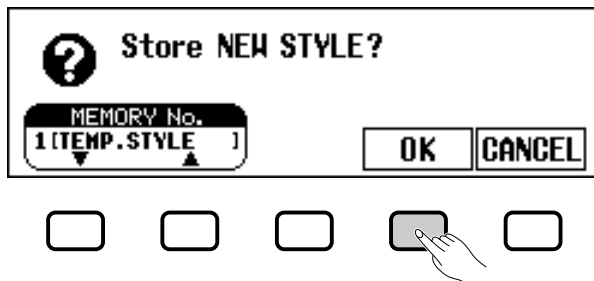

➤ Use the **MEMORY No.** ▼ and ▲ buttons, the data dial, or the [-] and [+] buttons to select the memory number (1 through 4) where you want to store the custom style, then press **OK** to store or **CANCEL** to abort.

### NOTE

If the selected memory number already contains a style, the style name will appear next to the memory number. The existing style will be overwritten when a new style is stored.

# Creating Your Own Styles

## ● Be Sure to Save Your Data!

Custom style data is not retained in memory when the power is turned off, so be sure to save your custom style before turning the power off (see page 82).

## ⓘ Exit when done.....

Press the [EXIT] button to exit the CUSTOM STYLE display and return to the main display.



## Other Custom Style Functions

In addition to the various functions described in the basic custom style recording procedure, above, the CUSTOM STYLE display pages include several other functions that you may find useful when creating custom styles.

## ■ RECALL SECTION function .....

This function makes it possible to recall the last-stored version of the currently selected section (all parts of the section are recalled). Simply press the **RECALL SECTION** LCD button in page 2 of the CUSTOM STYLE display. If the Clavinova cannot recall the preceding operation (i.e., after time signature has been changed), the “**Can’t recall!**” message will be displayed. If this happens, press **OK** to return to the previous display.

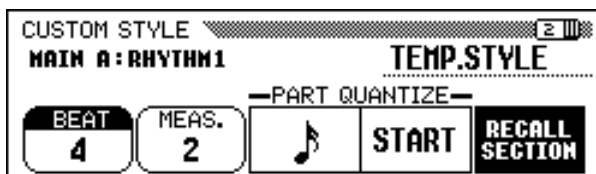

## ■ STYLE CLEAR function .....

Press the **STYLE CLEAR** LCD button in page 3 of the CUSTOM STYLE display to completely clear the current custom style. The “**Are you sure?**” message will be displayed. Press **YES** to clear the style, or **NO** to cancel the change.

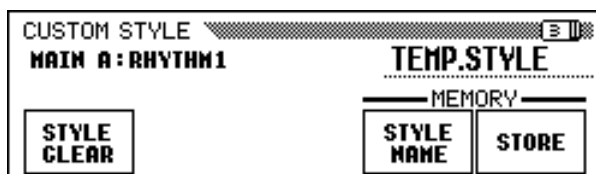



■ **Volume and Effects** .....

Page 4 of the CUSTOM STYLE display includes several functions that let you set the volume, reverb, chorus type and depth, and pan for each part of each custom style section.

**1** Select the section and part.

Use the **SECT.** function to select a section (or select **ALL** for all sections), and the **PART** function to select a part (or select **ALL** for all parts).

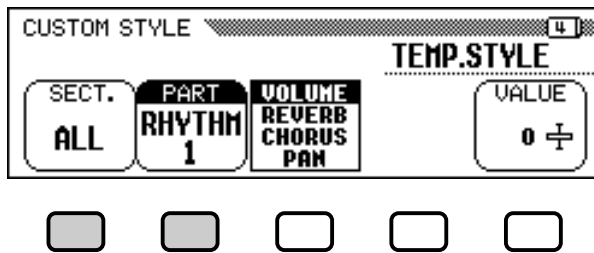

**2** Select the parameter you want to set.

The third LCD button selects the parameter to be set for the current section and part. Choose from **VOLUME**, **REVERB**, **CHORUS**, or **PAN**.

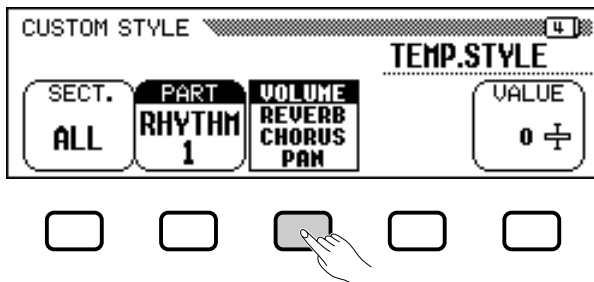

**3** Select the chorus type.

If you selected **CHORUS** in step 2, the **TYPE** function is displayed above the fourth LCD button. Use this function to select the chorus type you want to apply to the current section and part.

**Chorus Type List**

- CHORUS 1
- CHORUS 2
- CHORUS 3
- CELESTE 1
- CELESTE 2
- CELESTE 3
- FLANGER 1
- FLANGER 2
- OFF

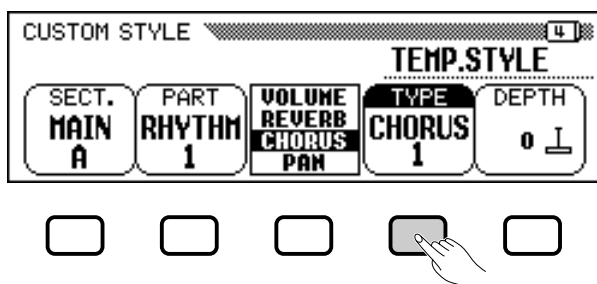

## 4 Set the value or depth of the selected parameter.

The **VALUE** (or **DEPTH**) function displayed above the rightmost LCD button sets the amount or depth for the parameter selected in step 2.

When **VOLUME** is selected, the **SECTION** setting is fixed at **ALL** and the **VALUE** range is from **-50** to **+50** (this value is relative to the preset volume of the source style). When the **REVERB** or **CHORUS** parameter is selected, the **DEPTH** can be set in a range from **0** to **127**. When **PAN** is selected, the **VALUE** function can be set in a range from **L10** (full left) to **C** (center) to **R10** (full right).

## 5 Repeat as necessary.

Repeat the preceding steps to set other parameters for each part and section in the custom style.

## ■ Saving Styles to Disk

Page 5 of the **CUSTOM STYLE** display lets you save custom styles on a disk. You can save custom styles individually, or in a complete set of up to four styles.

After inserting a properly formatted disk (page 111) in the Clavinova's disk drive, use the **MEMORY No.** ▼ and ▲ buttons to select the custom style you want to save to disk, or select **ALL** to save a complete set of up to four custom styles. When this is done, press the **SAVE** LCD button to start saving the data to disk. At this point the **SAVE** display appears.

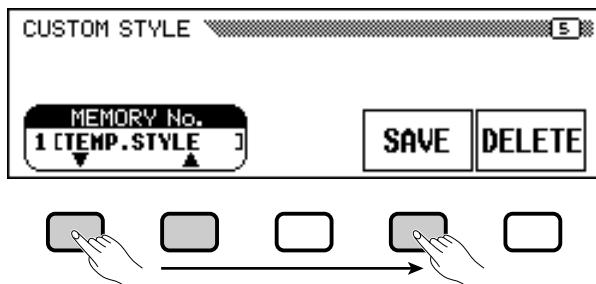

Enter a name for the style file. The procedure for entering the filename is the same as that used to enter a name for a custom style (page 140). Press **SAVE** when the name has been entered. If a file with the same name already exists, the “**Same name! Overwrite?**” message will be displayed. Press **OK** to overwrite the existing file, or **CANCEL** to abort the save operation.

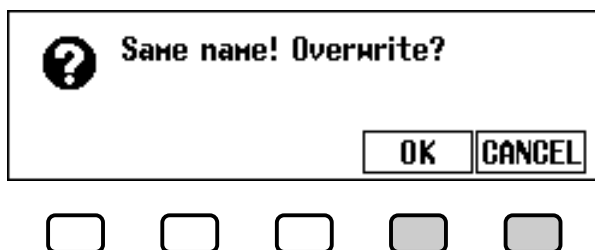

### NOTE

- The reverb type used for the custom style are determined by the style that was selected as the basis for custom style creation.
- Normally the **VALUE** and chorus **TYPE** settings from the preset style are initially selected. If the **PART** function is set to **ALL**, the preset values for part **R1** are displayed. If the **SECTION** function is set to **ALL**, the preset values for **MAIN A** are displayed.
- The word “**OTHERS**” may appear as the chorus type if the preset style uses a chorus type other than those in the list. The **OTHERS** setting cannot be re-selected once you select a different chorus type.

Custom styles must be stored in the Clavinova's memory before they can be saved to a disk. If a custom style has not been stored and you attempt to save it to disk, the “**Store in memory before saving to disk**” message will be displayed. If this happens, press **OK** to return to page 5 of the CUSTOM STYLE display. Store the custom style (see step 12 on page 79), then try saving again.

**NOTE**

Style files can be loaded from disk using the ALL LOAD and SINGLE LOAD functions, as described in the “Loading Style Files” section (page 86).

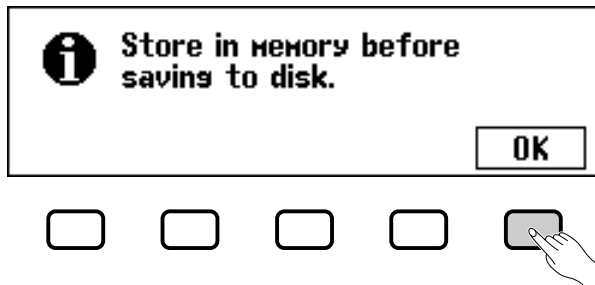

## ■ Deleting Style Files .....

Style files can also be deleted from a disk using the DELETE function on page 5 of the CUSTOM STYLE display.

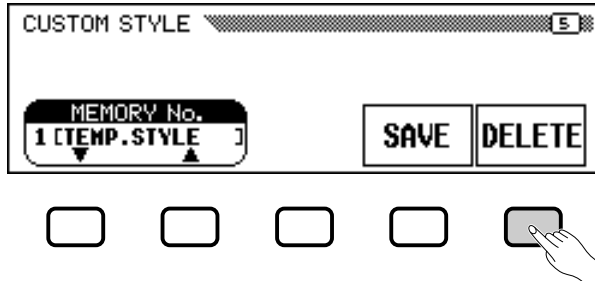

After inserting a disk that contains style files in the Clavinova disk drive, press the **DELETE** LCD button. Use the **FILE** ▲ and ▼ buttons to select the style file you want to delete from the disk. The “**Are you sure?**” message will be displayed. Press **YES** to delete the style file, or **NO** to cancel.

## ■ Exiting Custom Style Mode .....

Press the **[EXIT]** button to exit the Custom Style mode and return to the main display.

## Playing Back Your Custom Styles

Once created, your original custom styles can be selected for playback by pressing the [DISK/CUSTOM] button, then using the **STYLE** ▲ and ▼ LCD buttons, the data dial, or the [-] and [+] buttons to select the custom style you want to play. The selected style can then be played in exactly the same way as the preset styles (page 51).

**NOTE**

Since only one intro pattern, one fill-in pattern, and one ending pattern can be recorded for each custom style, no intro, fill-in, or ending variations are produced during playback.

## Messages in Custom Style Mode

The following messages may appear when creating and storing a style in Custom Style mode.

### ■ Memory Full During Recording .....

This message will be displayed if the memory becomes full during recording or editing.

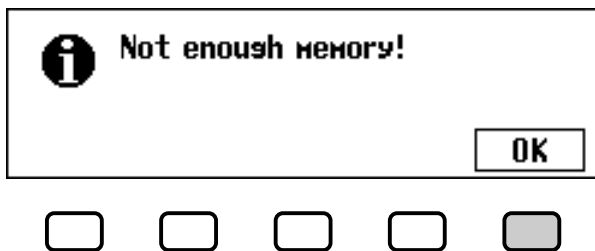

Press **OK** to return to the CUSTOM STYLE display, then simplify the style by clearing a part, etc.

### ■ Insufficient Memory To Store .....

This message will be displayed if there is not enough memory to perform a store operation.

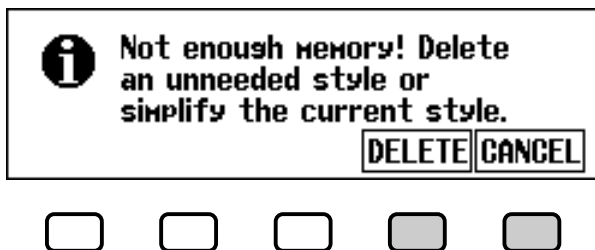

In this case it will be necessary to either delete a style you don't need, or simplify the style you are currently recording. Press **CANCEL** to return to the CUSTOM STYLE display and simplify the current style (by clearing a part, etc.), or **DELETE** to delete one or more styles.

If you select the **DELETE** function, the "Select style to delete" message will be displayed:

**NOTE**

The amount of memory being used by each style is displayed next to the style name (in approximate kilobytes). You can refer to this amount to judge how much memory (out of the total 100 KB) will become available when a particular style is deleted.

Use the **MEMORY No.** ▼ and ▲ buttons to select the style you want to delete, then press **OK** to delete the style, or **CANCEL** to cancel the operation.

If the Clavinova displays the “**Can’t delete this style!**” message when you try to delete a style, it is because you have tried to delete the style that your custom style was based on. If this happens, press **OK** to return to the “**Select style to delete**” display, then select a different style to delete.

## ■ Exit Before Store .....

If you press [EXIT] button to exit the Custom Style mode before storing the style, the Clavinova will display a message like the one shown below:

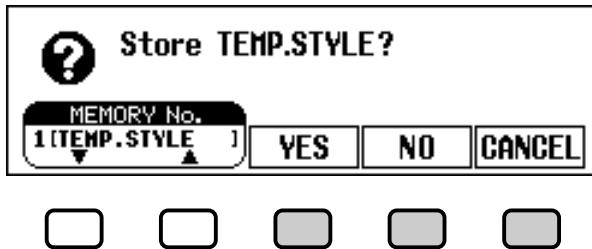

Select a memory number and press **YES** to store the style and exit, press **NO** to exit without storing the style, or press **CANCEL** to return to the Custom Style mode.

## ■ Style Change Before Store .....

If you attempt to select a different source style before storing the style you’ve just edited, the following display will appear:

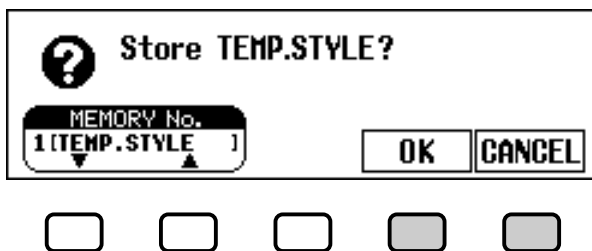

Select a memory number and press **OK** to store the style and select a new source style, or press **CANCEL** to return to the Custom Style mode.

### NOTE

*If you want to select a different source style without storing the current style, exit the Custom Style mode without storing the style (see “Exit Before Store” above), then re-enter the Custom Style mode.*

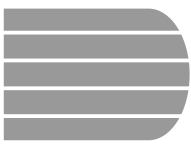

# Using Style Files .....

You can load and play style files created in the Style File Format either from optional Yamaha “Style File” disks, or from disks containing custom style files you’ve created yourself.

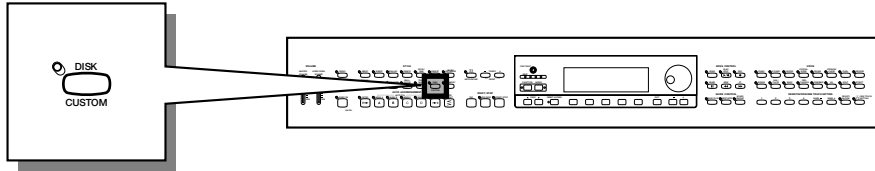

## About the Yamaha Style File Format

The Style File Format is Yamaha’s original auto-accompaniment format, which has evolved through years of development and refinement. The Style File Format features a unique conversion system that allows you to play exceptionally high-quality accompaniments with a variety of chord types. In addition to the internal styles, the Style File Format lets you use other sophisticated styles from optional Style File disks, as well as styles that were created and saved to disk in the Custom Style mode.

### NOTE

Style files created for Clavinova models prior to the CVP-103 may have slightly different formats. If you try loading such files, the data may not play back as expected. (This also applies to the use of CVP-103 style data by earlier-model Clavinovas.)

## Loading Styles from a Disk

### 1 Insert a disk.....

Insert a disk containing style files into the disk drive. The [DISK IN USE] lamp will light briefly while the Clavinova reads and identifies the disk. When a Style File disk is inserted, the STYLE FILE LOAD display (see step 2 below) will appear automatically.

If the disk is already inserted and the STYLE FILE LOAD display is not showing, press the [DISK/CUSTOM] button to open the DISK/CUSTOM STYLE display, then press the **LOAD SINGLE** button.

### NOTE

If a disk containing both song data and style files is inserted, the SONG PLAY display will automatically appear. If this happens, press the [SONG] button or the [EXIT] button to return to the main display, then press the [DISK/CUSTOM] button.

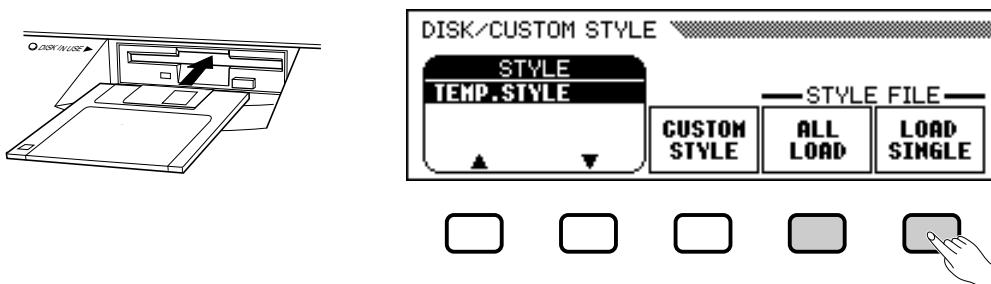

To load a set of four style files that was created by selecting ALL as the memory number when the files were saved in Custom Style mode (see page 82), press the **ALL LOAD** LCD button rather than the **LOAD SINGLE** button.

## 2 Select a style file.....

Select the desired style using the data dial or the [-] and [+] buttons.

You can preview the selected style by pressing the **LISTEN** LCD button. (The **LISTEN** function is not available in the ALL LOAD display.) To stop listening, press the **LISTEN** LCD button again, or press the **[START/STOP]** button.

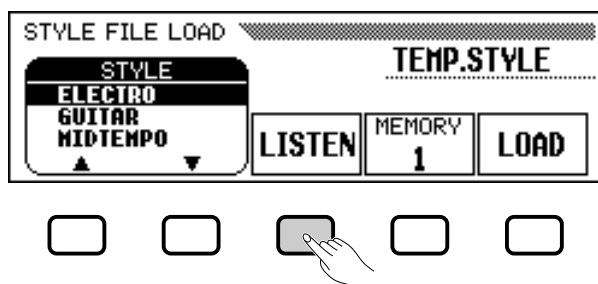

## 3 Select a memory number and load the style.....

Use the **MEMORY** LCD button to select the memory number to which the selected style file is to be loaded (1 through 4), then press the **LOAD** LCD button to load the style file.

Repeat steps 2 and 3 to select and load other style files.

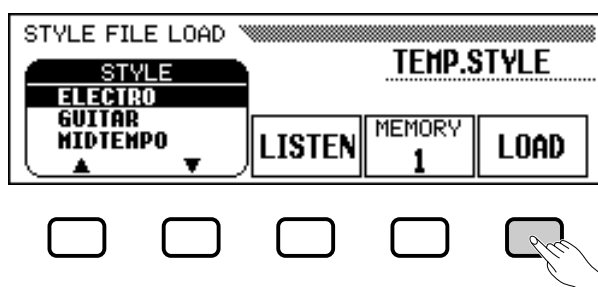

It is not necessary to select a memory number when **ALL LOAD** is selected in step 1. Simply press **OK** to load or **CANCEL** to abort.

If there is not enough memory to load the specified style file, the “**Not enough memory! Delete an unneeded style?**” message will be displayed. In this case it will be necessary to delete a style you don’t need before loading the new style. Use the **MEMORY No.** ▼ and ▲ buttons to select the number of the style you want to delete, then press **DELETE** to delete the style, or **CANCEL** to abort.



### NOTE

- If a tempo is set prior to loading the style, that tempo becomes the default for the loaded style.
- Some styles are too large to preview with the **LISTEN** function. In this case the “Too much data for **LISTEN** function! Please load data.” message will be displayed. If this happens, load the style directly as in step 4.
- The Auto Accompaniment is automatically turned on when the **LOAD SINGLE** button is pressed, and the style is played back automatically with the Auto Accompaniment in C Major when the **LISTEN** LCD button is pressed. You can change the chord or try playing on the keyboard while previewing a style.

### NOTE

- If the selected memory number already contains a style, the name of that style will appear above the **MEMORY** and **LOAD** functions in the display. The existing style will be overwritten when a new style is loaded. (One pre-programmed temporary style is automatically loaded into the **[DISK/CUSTOM]** memory whenever the power is turned on.)

### NOTE

- The **ALL LOAD** display is as follows:

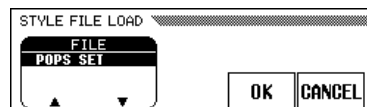

When **ALL LOAD** is executed, all data in the four memories will be replaced by new data.

- The amount of memory being used by each style is displayed next to the style name (in approximate kilobytes). You can refer to this amount to judge how much memory (out of the total 100 KB) will become available when a particular style is deleted.

# Using Style Files

## 4 Eject the disk when you're done.....

When you've finished with the Style File disk, press the disk drive EJECT button to remove it and return to the normal play mode display. You can return to the normal play mode without removing the disk by pressing the [EXIT] button.

### CAUTION

The [DISK IN USE] lamp will light while the style is being loaded. NEVER attempt to remove a disk while the [DISK IN USE] lamp is lit.

### NOTE

The LISTEN, LOAD, [EXIT], and STYLE buttons will not function while the style data is being loaded (i.e., while the [DISK IN USE] lamp is lit).

## Playing Loaded Style Files

Once loaded, style files can be selected for playback by pressing the [DISK/CUSTOM] button, then using the STYLE ▲ and ▼ LCD buttons, the data dial, or the [-] and [+] buttons to select the style you want to play. The selected style can then be played in exactly the same way as the preset styles (page 51).

### NOTE

Loaded disk styles will be retained in memory only until the power is turned off.

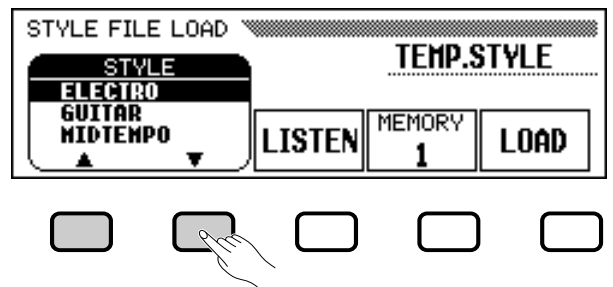
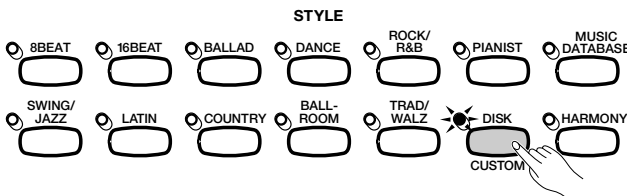



# CHAPTER 6: Registrations

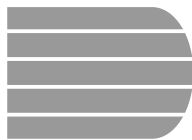

## Using Registrations (Registering and Recalling Panel Setups)

The Registration feature lets you store complete panel setups that you can recall whenever needed. A total of 20 setups (5 banks containing 4 memories each) can be registered in the Clavinova's memory.

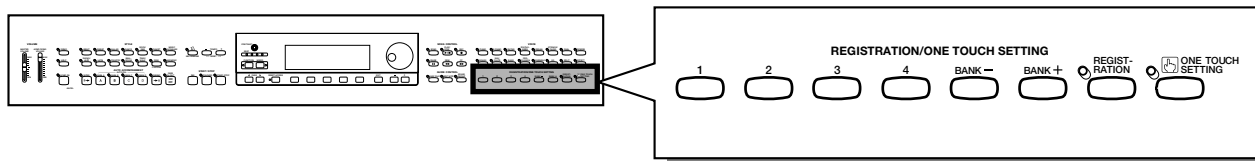

### Storing a Panel Setup

Use the following procedure to store a panel setup as a registration in the Clavinova's memory.

#### 1 Set up the controls as needed.....

For a list of the settings that are memorized by the Registration function, refer to page 13 of the Reference Booklet.

#### 2 Select a registration bank.....

Use the [BANK +] and [BANK -] buttons to select the desired bank.

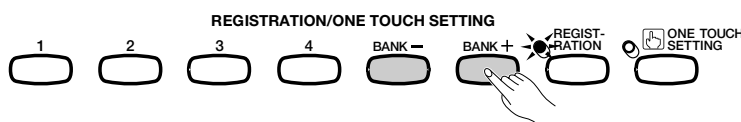

→ The selected bank is displayed in the upper left corner of main display.

Registration bank



#### NOTE

##### Registration bank

- Range: A — E
- Basic setting: A

# Using Registrations

## 3 Register the panel setup.

While holding down the [REGISTRATION] button, press one of the buttons labeled [1] through [4] under REGISTRATION/ONE TOUCH SETTING corresponding to the registration memory where you want to save the setup.

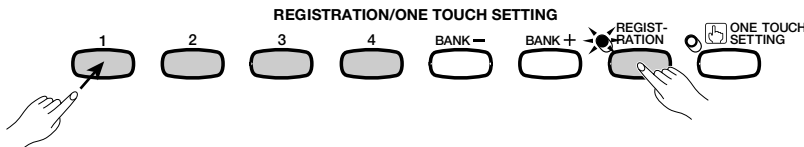

→ The number of the selected registration memory appears next to the bank name in the upper left corner of the main display. The panel settings that were previously stored in the selected registration are cleared and replaced by the new settings.

Registration number



### NOTE

#### Registration Memory

- Range: 1 — 4 (each bank)
- Basic setting: None

### NOTE

- Pre-programmed settings are initially stored in all registration memories when the Clavinova's power is first turned on.
- By default, the registration settings are preserved even when the Clavinova's power is turned off (see page 152). You can also save individual registrations (or complete sets of 20 registrations) to floppy disk for future recall (see page 139).

## Recalling the Registered Panel Settings

### 1 Press the [REGISTRATION] button.

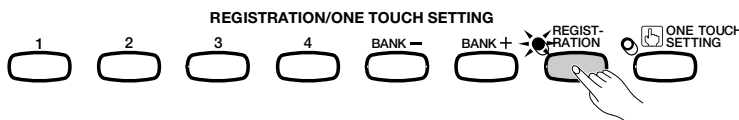

→ The [REGISTRATION] lamp lights.

### 2 Select a bank.

Use the [BANK +] and [BANK -] buttons to select the bank that contains the desired registration.

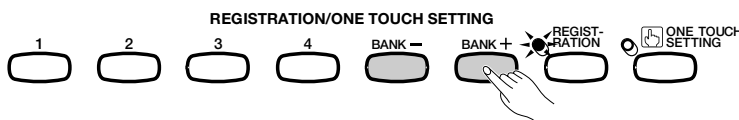

→ The selected bank is displayed in the upper left corner of the main display.

### 3 Select a registration.

Press one of the buttons labeled [1] through [4] under REGISTRATION/ONE TOUCH SETTING corresponding to the registration memory you want to recall.

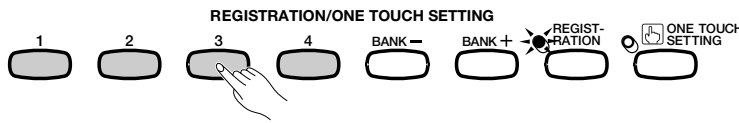

→ The number of the recalled registration appears next to the bank name in the upper left corner of in the main display.

A pencil icon will appear to the right of the registration number in the display as soon as any change is made to the panel buttons or settings. The pencil icon is displayed to remind you that the current panel settings are different from those stored by the Registration function.



**NOTE**

- Registered panel settings are not recalled when a bank is selected. The settings are recalled only when one of the numbered buttons ([1] through [4]) is pressed.
- When the LEFT PEDAL function is set to REGISTRATION (see page 138), the left pedal can be used to select the registration memories in sequential order (A1 through E4), letting you recall a different registration each time the pedal is pressed. However, other left pedal settings saved by the Registration function cannot be recalled in this case.

## Protecting Panel Settings

You can use the Registration Freeze function to prevent certain panel settings from being changed when a Registration is recalled. This allows you to recall various registrations while using the Auto Accompaniment without suddenly changing the style or volume settings.

### 1 Open the REGISTRATION [FREEZE] display. ....

Press [DIRECT ACCESS], then [REGISTRATION].

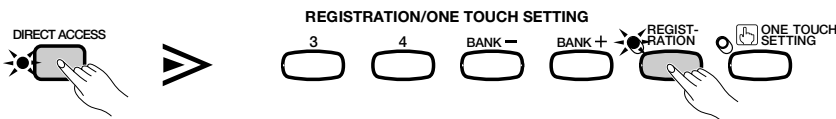

→ The REGISTRATION [FREEZE] display appears.

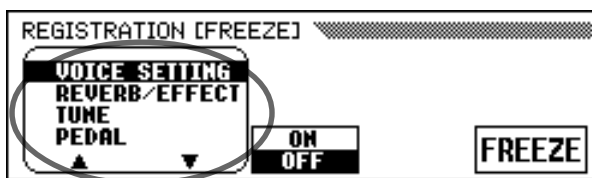

Freeze categories

Categories to be frozen are marked by an asterisk (\*) in the menu listing. Also, the **ON** setting (in the **ON/OFF** function over the middle LCD button) is highlighted when a category to be frozen is selected.

**NOTE**

For a list of the settings in each freeze category, see page 13 in the Reference Booklet.

# Using Registrations

## 2 Indicate the categories to be frozen.....

Use the ▲ and ▼ buttons, the data dial, or the [-] and [+] buttons to select a category, then press the **ON/OFF** button to mark or unmark the selected category.

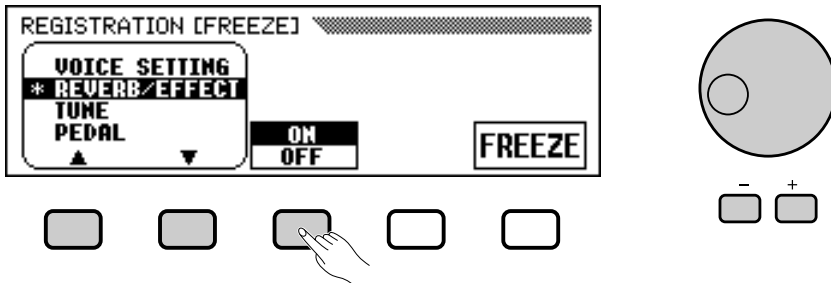

Repeat this step to mark or unmark other categories, as needed.

## 3 Turn the Freeze function on or off.....

Press the **FREEZE** LCD button to freeze or unfreeze the categories you marked in step 2.

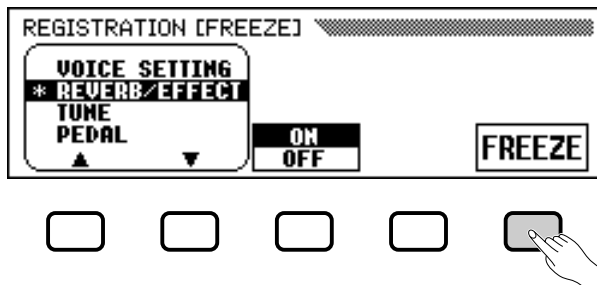

→ The **FREEZE** function is highlighted when the marked categories are frozen. When the Freeze function is off, the settings in all categories are not protected.

## 4 Exit the display. ....

To exit the REGISTRATION [FREEZE] display and return to the main display, press **[EXIT]**.

### NOTE

#### Freeze Categories

- Settings: ON, OFF
- Basic setting: ON (ACMP SETTING)  
OFF (others)
- Backup of last settings: ON

### NOTE

#### FREEZE

- Settings: ON (highlighted),  
OFF (unhighlighted)
- Basic setting: OFF
- Backup of last setting: ON

# CHAPTER 7: Song Control



## Song Playback

The Clavinova can play back songs recorded using the Song Record function (page 110), as well as song data included on various commercially available software disks. You can also play along on the keyboard as the songs play back. Moreover, when song data software includes lyrics, you can view the lyrics in the display during playback.

**NOTE**

• See “Handling the Floppy Disk Drive (FDD) and Floppy Disks” (page 9) for information on using floppy disks.

**NOTE**

• The Clavinova can play back up to 99 songs recorded on a single disk. Any songs exceeding this number will not be available for playback.

**NOTE**

• Playback data is normally not output via MIDI. However, you can set the Clavinova to output song data using the Song Transmission function in the FUNCTION [MIDI 4] display (page 150).

**NOTE**

• In addition to songs you’ve recorded yourself, the CVP-103 can play back commercially available disks of Yamaha DOC software, XG software, and Disklavier PianoSoft as well as GM software. See “Playing Other Types of Music Data” on page 104.

• Consult your Yamaha dealer for information on song data that is compatible with the Lyric Display function of the Clavinova.

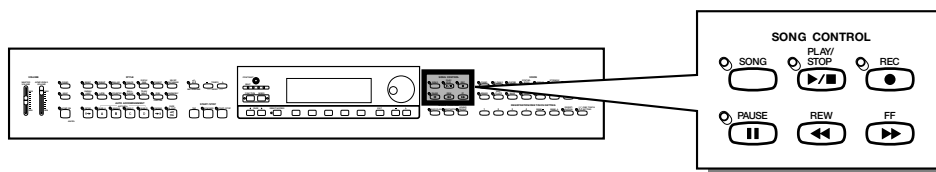

## Song Playback

### 1 Enter the Song Play mode.

Gently insert the included “Music Software Collection” disk or a disk containing songs you’ve recorded yourself into the disk drive. Make sure to insert the disk face up in correct direction, as shown in the illustration, until it clicks into place. The Song Play mode is automatically called up when a song disk is inserted in the disk drive.



**NOTE**

The Song Play mode is not automatically engaged if the disk is inserted when one of the disk-related FUNCTION displays (page 139) or the CUSTOM STYLE display (page 74) is showing.

# Song Playback

- The DISK IN USE lamp lights while the Clavinova reads and identifies the disk. Once the disk has been identified, the SONG PLAY [MAIN] display (display page 1) appears and the [SONG] lamp lights.

If a song disk has been inserted but the Song Play mode is not engaged, press the [SONG] button.

- The [SONG] lamp lights. Press the PAGE [◀] and [▶] buttons to select the first page, if the SONG PLAY [MAIN] display is not shown.

## 2 Select a song number.

Select the desired song number for playback by using the **SONG** button, data dial or [-] and [+] buttons.

- The selected song number, name, current tempo and the file icon which indicates the type of the file are displayed.

Select “**ALL**” if you want all songs on the disk to be played in order. Select “**RANDOM**” if you want all songs on the disk to be played at random. For either selection “**ALL**” or “**RANDOM**” the songs will be repeated until playback is stopped.

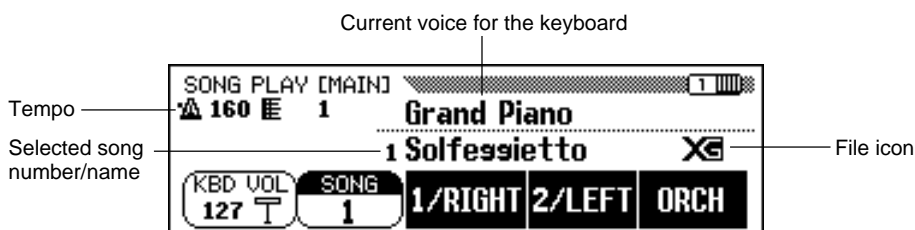

### NOTE

Song numbers 1 through 99 are displayed, including song numbers that contain no song data. However, no song names are displayed for song numbers that contain no data.

### ● File Icons

There are four icons (shown below) that indicate the type of the file.

Icons	File Type
XG	XG/SMF format file
DOC	DOC/ESEQ format file
Piano	Yamaha Disklavier PianoSoft or XG/ESEQ file
CVP	Song data recorded with the CVP-103

### NOTE

- Refer to “MIDI and Data Compatibility” (page 172) for information on file formats.
- Icons are not shown for GM song files or song data files recorded with CVP models other than the CVP-109/107/105/103, the CVP-98/96/600, or the CVP-94/92.

Use the PAGE [◀] and [▶] buttons to call up the SONG PLAY [LIST] display (display page 3), to view the entire list of the song names in the disk. The desired song can be selected easily by using the data dial or the [-] and [+] buttons. Up to eight song titles are shown in the display at a time. If more songs are on the disk, the next eight titles will appear when you scroll past the last title shown in the display.

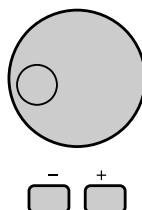
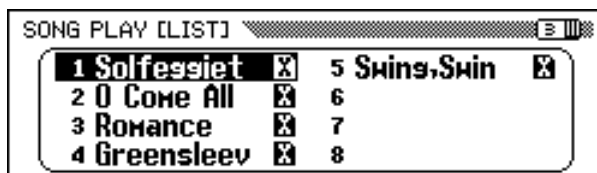

### NOTE

#### When nothing appears in the song name location...

This indicates that there is no song data for this song number.

### NOTE

#### Repeat Playback from a Specific Song

If you first select ALL in the SONG PLAY [MAIN] display, and then select a song in the SONG PLAY [LIST] display (display page 3), all songs will be repeatedly played back starting from the selected song.

### NOTE

#### Repeat Playback of a Single Song

If you select a song in the SONG PLAY [MAIN] display or in the SONG PLAY [LIST] display (display page 3), and then select 1 SONG in the SONG PLAY [REPEAT] display (display page 4), only the selected song will be played back repeatedly until stopped.

### NOTE

#### Voice Selection During Playback

The voice you play from the keyboard can be changed during song playback by selecting a voice in the normal way (page 29). The voices of the 1/RIGHT and 2/LEFT parts being played back can be changed in the SONG PLAY [L&R VOICE] display (page 98).

### NOTE

Please note that the song may not start immediately after you press [PLAY/STOP].

### NOTE

#### Turning off the Keyboard Guide Lamp

The keyboard guide lamps corresponding to the notes being played by the 1/RIGHT and 2/LEFT parts will light in real time. These guide lamps can be turned off in the SONG PLAY [GUIDE MODE] display (display page 5). (See page 109.)

### NOTE

#### Turning Off the Lyric Display

Lyrics are shown in the display when playing back software which contains lyric data. If you want to stop the lyrics from appearing, you can disable this function in page 5 of the SONG PLAY [GUIDE MODE] display.

### NOTE

#### Using the Pedal to Start/Stop Playback

When you set the Left Pedal Function to START/STOP in the FUNCTION [PEDAL] display (display page 3), the left pedal will function like the [START/STOP] button. (See page 138.)

## 3 Start and stop playback.....

Start playback of the selected song by pressing the [PLAY/STOP] button.

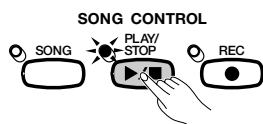

- Playback of the selected song starts. Unless **ALL** or **RANDOM** has been selected, the selected song will play through to the end, then playback will stop automatically. The current measure number and tempo will be shown in the display during playback.

You can also start playback of the selected song by pressing the [START/STOP] button.

Press the panel [PLAY/STOP] button to stop playback.

- Song playback stops.

You can also stop playback by pressing the [START/STOP] button.

To exit the Song Play mode, press [SONG] or [EXIT]. The lamp turns off and the previous display appears.

## ● Adjusting the Tempo

The playback tempo of the song can be changed as desired. (See page 25.) The preset tempo for the selected song can be restored at any time by simultaneously pressing the TEMPO [-] and [+] buttons.

Usually the tempo is indicated by numbers. However in case of the free tempo software, “- - -” will appear in place of the tempo in the display, and the measure numbers shown in the display will not correspond to the actual measure; this only serves as a reference as to how much of the song has been played back. The increase or decrease of the tempo based on the basic tempo is indicated by a percentage figure in the display when the tempo is changed (from -99 to +99 at maximum; the range differs depending on the software).

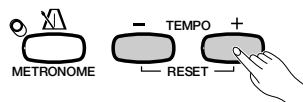

### NOTE

The BEAT lamps (page 52) may not flash during playback of free-tempo software.

### NOTE

With some songs, the displayed measure numbers may not match those marked on the score.

## 4 Eject the disk.

When you've finished with the currently loaded disk, simply press the disk drive's EJECT button to remove it.

➔ The LCD display returns to the main display.

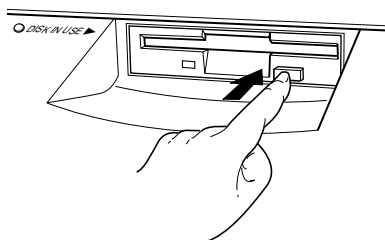

### CAUTION

Never take out the disk while the DISK IN USE lamp is lit or while a song is being played back.

### NOTE

#### Volume Adjustment for Each Part

The volume of each part can be adjusted in the MIXER display.

### NOTE

#### Adjusting the Level Balance of Song Playback and the Keyboard Voices

Use the [ACMP/SONG VOLUME] control (page 23) to adjust the volume.

### NOTE

When playing back a song recorded on the CVP-109/107/105/103, the Auto Accompaniment can be turned on by pressing the [ACMP ON] button.



## Part Cancel

The **1/RIGHT** (right hand), **2/LEFT** (left hand) and **ORCH** (accompaniment) buttons in the SONG PLAY [MAIN] display can be used to turn playback of the corresponding parts on or off. The buttons are highlighted when the parts are turned on. For example, you can turn off the right- and/or left-hand parts so you can practice them on the keyboard.



In this example, 1/RIGHT is canceled.

The track assignment for each button can be changed in display page 6 of the SONG PLAY [L&R VOICE] display (page 98).

### ■ Turning Individual Accompaniment Parts On or Off

Normally, pressing the **ORCH** (accompaniment) LCD button turns all orchestra parts (tracks 3 through 16) — or all parts other than **1/RIGHT** and **2/LEFT** — on or off at once. You can, however, turn these parts on or off individually in the SONG PLAY [TRACK PLAY] display (display page 2).

#### 1 Select the SONG PLAY [TRACK PLAY] page.

Use the PAGE [◀] and [▶] buttons to select the SONG PLAY [TRACK PLAY] display (display page 2).

- ➔ Tracks which contain data are indicated above the **TRACK** ◀ and ▶ buttons. Tracks enabled for playback are indicated by a box surrounding the track number. Tracks which do not contain data are not displayed.

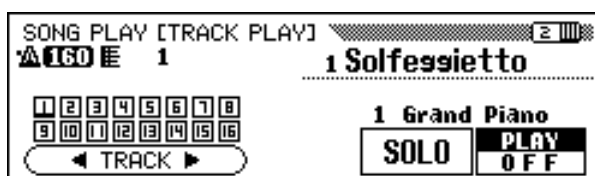

#### NOTE

- Parts can be switched on and off during playback.
- Parts not having any data cannot be turned on. This applies when there is actually no data in the assigned track (page 98), or when the track assigned to the 2/LEFT part is set to "TRK -- (OFF)."

#### NOTE

In the case of Yamaha Disklavier PianoSoft files, DOC files and XG/ESEQ files, the part indication does not appear for the parts without data.

#### NOTE

All track numbers appear whether, the tracks contain data or not, when a Standard MIDI file song is selected (except songs recorded on the CVP-109/107/105/103, the CVP-98/96/600, and the CVP-94/92).

## 2 Select the desired track for playback (PLAY/OFF, SOLO).

Select the track by using the **TRACK** ◀ and ▶ buttons, the data dial, or the [-] and [+] buttons.

➔ The selected track is indicated by an underline mark.

Turn playback on or off for the selected track by pressing the rightmost LCD button to select **PLAY** (playback) or **OFF**.

When a track is muted, the box surrounding the track number disappears. The voice used by the currently selected track is shown above **PLAY/OFF**.

Select a track, then press and highlight the **SOLO** LCD button to hear only the selected track. Press the **SOLO** LCD button again to cancel the Solo function.

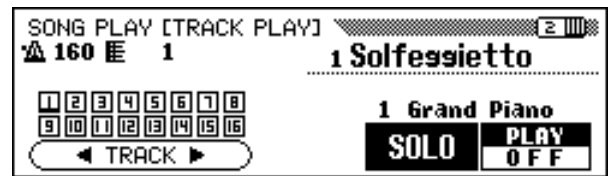
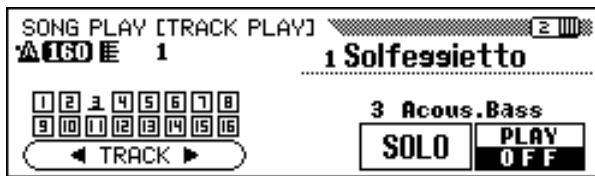

## Assignment of Tracks to 1 /RIGHT and 2 /LEFT, and Voice Assignment

### ■ Assigning Tracks to 1 /RIGHT and 2 /LEFT .....

Specific tracks can be assigned to the **1 /RIGHT** and **2 /LEFT** functions in the SONG PLAY [MAIN] display, allowing you to selectively turn playback of assigned tracks on or off. **TRK - - (OFF)** can be assigned to **2 /LEFT**. The same track cannot be assigned to both parts.

Select the SONG PLAY [L&R VOICE] display (display page 6) by using the PAGE [◀] and [▶] buttons.

➤ Press the **1 /RIGHT** button or the **2 /LEFT** button to highlight the corresponding function in the display, then use the data dial or [-] and [+] buttons to assign the desired track.

You can also select the track by pressing the **1 /RIGHT** or **2 /LEFT** button.

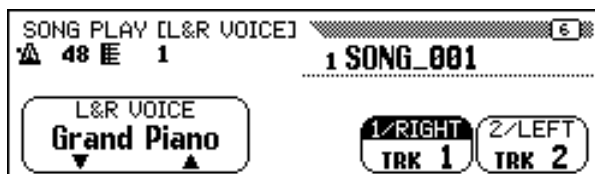

#### NOTE

##### 1 /RIGHT

- Settings: 1 — 16
- Basic setting: Depends on file type.

##### 2 /LEFT

- Settings: 1 — 16, -- (off)
- Basic setting: Depends on file type.

#### NOTE

The track assignments of DOC files and Yamaha Disklavier PianoSoft files are fixed, and therefore cannot be changed.

#### NOTE

Tracks can only be assigned when playback is stopped at the top of the song.

### ■ Selecting Voices for 1/RIGHT and 2/LEFT Parts

The playback voices for the 1/RIGHT and 2/LEFT parts can be selected in the SONG PLAY [L&R VOICE] display.

Press **L&R VOICE** ▼ or ▲ to highlight the corresponding function in the display, then select the playback voice for 1/RIGHT and 2/LEFT parts by using the data dial or [-] and [+] buttons.

You can also select a voice by using the **L&R VOICE** ▼ or ▲.

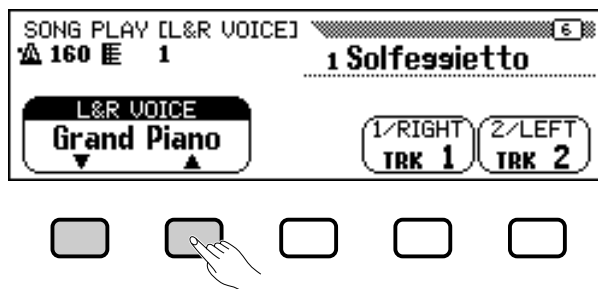

**NOTE**

The playback voice can only be changed when playback is stopped at the top of the song.

## Overall Song Playback Volume Control

The [ACMP/SONG VOLUME] slider can be used to control the overall volume of song playback.

When you enter the Song Play mode, the song volume level is automatically set to the volume level that was last set in the Song Play mode, regardless of the slider's position. After that, moving the slider will set the volume to the corresponding level.

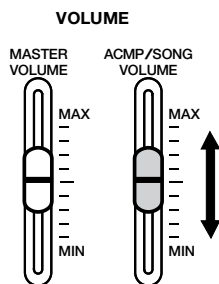

**NOTE**

If the Auto Accompaniment is turned on during playback of an original song that was recorded on the CVP-109/107/105/103, the [ACMP/SONG VOLUME] control will affect the level of the Auto Accompaniment rather than that of song playback.

## Adjustment of Track Settings

To adjust the playback volume, voice, and pan settings, as well as the reverb, chorus, and effect depth for individual tracks, press the [MIXER] button while in the Song Play mode to call up the MIXER display.

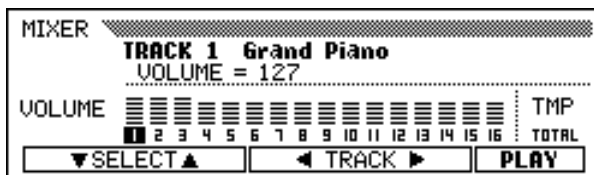
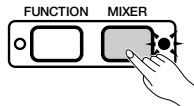

You can use the MIXER display to set the parameters listed below. See the indicated reference pages for descriptions of each parameter.

### Parameters available in the MIXER display

- **When track 1 — 16 is selected:**
  - VOLUME (See page 32.)
  - VOICE (See page 29.)
  - PAN (See page 32.)
  - REVERB DEPTH (See page 43.)
  - CHORUS DEPTH (See page 45.)
  - EFFECT DEPTH (See page 48.)
- **When TOTAL is selected:**
  - TEMPO (See page 25.)
  - Overall REVERB DEPTH (See page 42.)
  - REVERB TYPE (See page 42.)
  - CHORUS TYPE (See page 44.)
  - EFFECT TYPE (See page 47.)

#### NOTE

The Program Change Number (PRG#), Bank LSB (BKL), and Bank MSB (BKM) parameters, which are used to select voices via MIDI, are displayed when VOICE is selected.

#### NOTE

Depending on the file type, some parameters cannot be changed. For such parameters, a "Fixed" indication is shown.

## Changing Settings in the MIXER Display

### 1 Select the track to be changed.

Select the desired track by pressing **TRACK** ◀ or ▶. Selecting **TOTAL** will change the overall settings of the song rather than the settings of individual tracks.

Press the rightmost LCD button to select **PLAY** (playback), **OFF**, or **SOLO** for the selected track. Select **SOLO** if you want to play only the selected track.

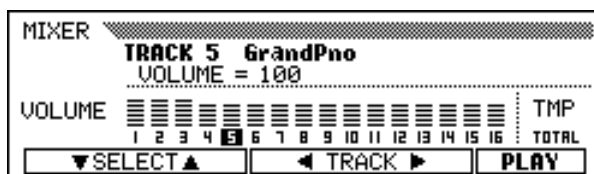

## 2 Select the parameter to be edited. ....

Press **SELECT** ▼ or ▲ to select the desired parameter.

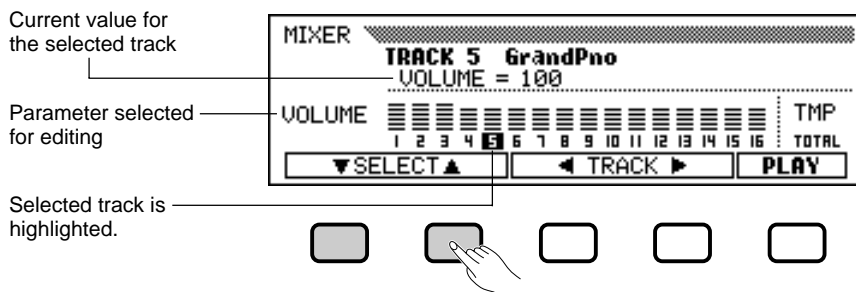

## 3 Edit the value or setting. ....

Use the data dial or [-] and [+] buttons to change the value or setting. You can make changes to the parameters while the song is playing back, letting you immediately hear the results of your edits.

### NOTE

Depending on the file type, voice changes may only be possible for tracks 1 and 2.

### NOTE

- Selecting **TOTAL** and changing the **REVERB DEPTH** value will also affect the sound of your keyboard performance.
- The voices of tracks to which **Auto Accompaniment**, **rhythm**, and **harmony** data have been recorded can also be changed.
- **Volume range: 0 — 127**
- If another song is selected, all settings will return to the basic settings for the song (or the settings used to record the song).
- If the **Auto Accompaniment** is turned on during playback of an original song that was recorded on the CVP-109/107/105/103, the **MIXER** display will function as **Auto Accompaniment Part Volume Control** (page 65) instead of **Song Track Volume Control**.

## Repeat Functions

The Clavinova has convenient repeat functions that let you repeatedly play back the same song or sections within the song. This function is useful when you want to practice a difficult phrase.

Select the desired mode from the available four Repeat modes from the **SONG PLAY [REPEAT]** display (display page 4).

### Four Repeat modes

- **OFF** (Repeat function is turned off)
- **PHRASE** (Phrase Repeat)
- **1 SONG** (1 Song Repeat)
- **AB mode** (AB Repeat)

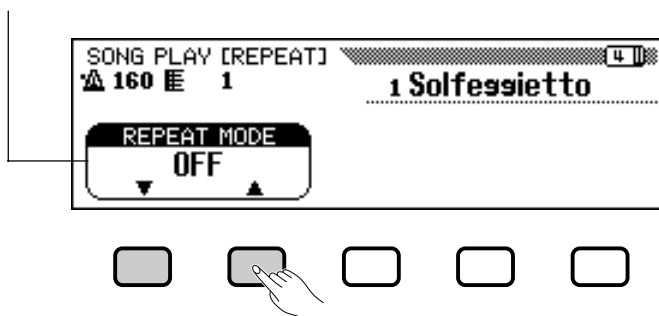

### NOTE

- The **ALL** or **RANDOM** playback mode (in the **SONG PLAY [MAIN]** display) will be disengaged when any of the Repeat modes are selected.
- Any previously set Repeat mode will be reset to **OFF** when a different song is selected.

## ■ Phrase Repeat

When playing back Yamaha software that includes special phrase marks, such as DOC files, you can select specific phrase numbers (as indicated on the accompanying sheet music) and repeatedly practice only the selected phrase. (Phrase Repeat can be used for the four songs for which notation is provided in the included Music Book.)

If you select **PHRASE** by using the **REPEAT MODE** ▼ or ▲ buttons, the **PHRASE** display for selection of the phrase number will appear at the right of the button. Press **PHRASE** ▼ or ▲ to highlight the corresponding function in the display, then select the phrase number by using the data dial or [-] and [+] buttons.

You can also select the phrase number by pressing **PHRASE** ▼ or ▲.

Once song playback is started, the selected phrase will be played back repeatedly until playback is stopped.

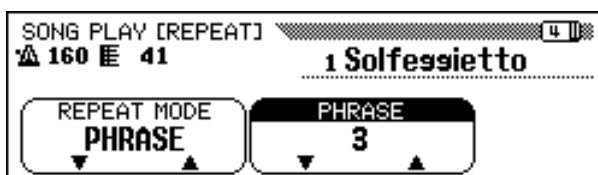

## ■ 1 Song Repeat

When **1 SONG** is selected by pressing the **REPEAT MODE** ▼ or ▲ button, any song selected and played as described above will play repeatedly until stopped.

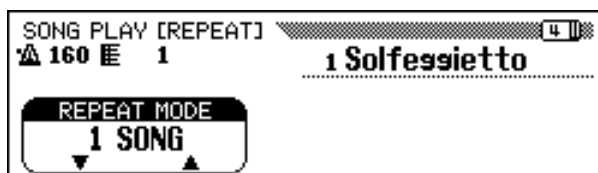

## ■ AB Repeat

This function allows you to specify any section (between point A and point B) of a song, letting you repeatedly play back the selected section for practice.

When **AB mode** is selected by the **REPEAT MODE** ▼ or ▲ buttons, **A →** and **B** will appear at the right of the buttons in the display to specify points A and B.

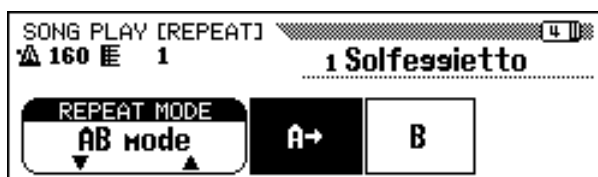

### NOTE

- Parts can be turned on/off even during the performance.
- The Guide function can also be used simultaneously with Phrase Repeat.
- When Phrase Repeat is started, a lead-in count automatically plays before the phrase. However, for free-tempo songs, a lead-in count is not available.

### NOTE

Lead-in count is not played.

### NOTE

- The specified A and B points will be erased when a new song number or another Repeat mode is selected.
- A lead-in count automatically plays before the specified section A-B Repeat playback is started. However, for free-tempo songs, a lead-in count is not available.
- To specify the A point as the beginning of the song, press A → before playback starts. In this case a lead-in count is not available.
- Specifying only the A point results in repeat playback between the A point and the end of the song.
- The B point cannot be selected unless an A point is selected.

While the song is playing back, press the **A** → button once at the beginning of the section to be repeated.

- Then, press the **B** button at the end of the section to be repeated. Repeat playback of the specified section (from point A to point B) will begin automatically.

The programmed A and B points are retained until a different song or a different Repeat mode is selected. The same section can be played back repeatedly as many times as you desire by using the [PLAY/STOP] button.

When both the A and B points have been specified, you can clear the A and B points by pressing the **A** → button, or just the B point by pressing the **B** button. You can then specify other A and B points within the song.

## Other Playback Controls

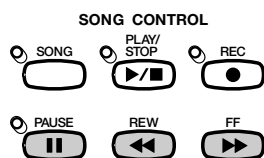

### ■ Pause .....

Press the [PAUSE] button during song playback to temporarily stop song playback. Press [PAUSE] again or the [PLAY/STOP] button to resume playback from the same point.

### ■ Rewind and Fast Forward .....

Use the [REW] and [FF] buttons to rewind or fast forward to the playback point of the song.

- While playback is stopped or paused, the [REW] and [FF] buttons can be used to step backward or forward through the song a measure at a time. Holding down either button continuously moves through the song in the corresponding direction.
- During playback, the [REW] and [FF] buttons allow you to move the playback point of the song rapidly as long as the button is held. No sound is produced during [REW] operation.

**NOTE**

Using the [REW] button may cause the voice, tempo, and/or volume to change.

## Playing Other Types of Music Data

### ■ About Compatible Software .....

The CVP-103 can play back the following types of software.

- **Sequence formats: SMF (format 0 and 1), ESEQ**
- **Voice allocation formats: GM System Level 1, XG, DOC**

Refer to “MIDI and Data Compatibility” (page 172) for information on the voice allocation formats and sequence formats.

The internal tone generator of the CVP-103 automatically resets for compatibility with either the Yamaha XG format (including GM System Level 1) or the Yamaha DOC voice allocation (page 172), depending on the playback data. (However, the selected voice allocation on the panel will not change.)

### ■ Song Data Recorded on Other Instruments .....

Song data recorded on other Clavinovas (CVP-50/70/55/65/75/83S/85A/87A/59S/69A/69/79A/89/92/94/96/98/600/109/107/105) will normally be played back with the correct voices even though the volume balance may be slightly different. However, data recorded using the Auto Accompaniment function of the CVP-50/70 cannot be played back properly.

Song data recorded on the Yamaha Disklavier can also be played back.

#### NOTE

*The Lyric Display function (page 109) cannot be used with song data recorded in SMF format 1.*

#### NOTE

*Regardless of the type of software, only the following disk formats can be used: 3.5" 2DD 720 kilobyte format and 3.5" 2HD 1.44 megabyte format.*



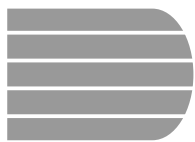

# Guide Control.....

The Clavinova has a special Guide function which allows you to practice by using the appropriate disk software. The “piano roll” display and the keyboard guide lamp indicate which keys you should play, and when you should play them. You can even practice at your own pace since the Clavinova pauses playback of the accompaniment until you play the correct keys. (You can try out the Guide function by pressing one of the GUIDE CONTROL buttons during playback of the “4. GUIDE Demo” song in the Demo mode.)

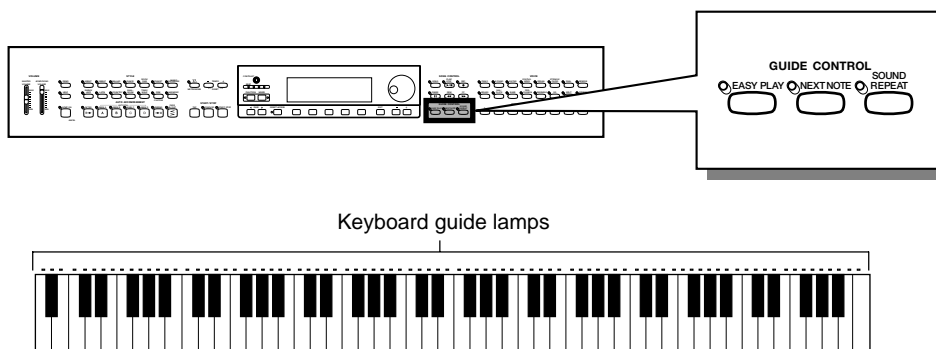

## Guide Methods and Piano Roll

The Clavinova has three different Guide methods that can be selected depending on your playing experience or preferences. Beginning players should practice first with Easy Play, then go on to Next Note, then Sound Repeat.



### NOTE

“FOLLOW LIGHTS” and “CueTIME” software should be used with the Next Note method, as the Easy Play and Sound Repeat methods may not function properly with such software.

### ■ Practicing the Timing: Easy Play .....

Since the Easy Play method lets you practice only the timing of the notes, you can play anywhere on the keyboard. The melody will play back smoothly when you play with the correct timing. (The accompaniment plays back normally in tempo.)

### ■ Practicing the Notes: Next Note .....

The Next Note method lets you check which notes to play by looking at the piano roll display and the keyboard guide lamps. Since the Clavinova waits to play the accompaniment until you play the correct note, you can practice at your own pace.

The keyboard guide lamps indicate the timing in which to play, by changing from lit-up to flashing.

### NOTE

**If the guide lamps do not flash...**  
The guide lamps may not flash in the case of a few songs because of a special guide system. In case of such songs, however, you can switch to the Next Note method so that the lamps flash, if you like. See the “Other Guide-related Functions” on page 108.

**If the guide lamps and piano roll are transposed up or down...**  
The guide lamps and piano roll may be transposed up or down by one or two octaves for certain songs. The guide lamps and piano roll will not indicate notes exceeding the 88-key range of the keyboard.

## ■ Practicing Phrase-by-Phrase with the Playback: Sound Repeat .....

In the Sound Repeat method, the Clavinova plays back a short phrase. Listen to the phrase and practice.

As soon as you play the phrase correctly, the Clavinova will automatically play the next phrase.



### Number of Repeats

You can set the number of times the phrase will be repeated in the SONG PLAY [GUIDE MODE] display (display page 5). (See page 109.)



The keyboard guide lamps can be turned on or off as desired in the SONG PLAY [GUIDE MODE] display (display page 5). (See page 109.)

## ● Piano Roll

To show the piano roll in the display, press any GUIDE CONTROL button, then press the [PLAY/STOP] button to start playback. A bar of the same length as the note to be played scrolls down from the top of the display toward the bottom. You should play the note at the time the bar reaches the bottom of the display. In order to play the note with the correct duration, hold the note for as long as the bar remains in the display.

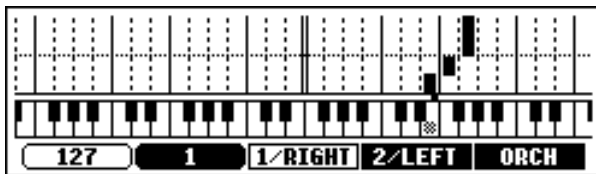

### Piano Roll ON/OFF

The piano roll display can be turned on or off from the SONG PLAY [GUIDE MODE] display (display page 5). (See page 109.)

## Using the Guide Function

### 1 Set up the desired song for practicing. ....

Check that the disk is properly inserted in the disk drive before calling up the Guide function.



➤ Select the song and cancel the part that you wish to practice yourself from the SONG PLAY [MAIN] display (display page 1).



### Before Practicing

Before starting to practice, play back the entire song without canceling the part to be practiced and listen to it carefully. This will give you a clear idea of how the song should be played, and will make your practice sessions progress more smoothly.



### Auto Part Cancel

If you turn on the Guide function without canceling playback of the part to be practiced, 1/RIGHT part is guided (or the 2/LEFT part is guided when the 1/RIGHT part contains no data). However, when you cancel the part before turning on Guide, the setting will be kept until the song is changed.

## 2 Select the Guide method. ....

Press one of the GUIDE CONTROL buttons: [EASY PLAY], [NEXT NOTE] or [SOUND REPEAT].



→ The lamp of the corresponding button lights.

## 3 Practice the part. ....

Press the [PLAY/STOP] button to start playback.

→ The piano roll will appear. Practice along with the accompaniment.

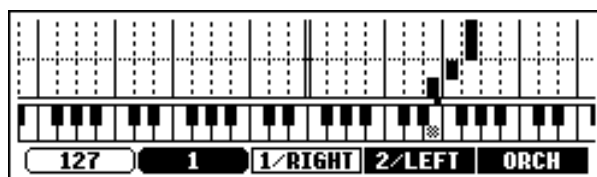
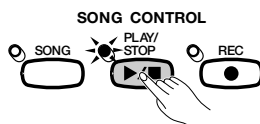

## 4 Stop your practice session. ....

The Guide function stops automatically when playback reaches the end of the song. You can also stop song playback by pressing the [PLAY/STOP] button.

To turn off the Guide function, press the appropriate button - [EASY PLAY], [NEXT NOTE] or [SOUND REPEAT] - so that the lamp turns off.

### NOTE

#### Turning Off the Keyboard Guide Lamps

The keyboard guide lamp can be turned on and off in the SONG PLAY [GUIDE MODE] display. (See page 109.)

### NOTE

#### When the GUIDE CONTROL buttons cannot be turned on...

The GUIDE CONTROL buttons can be used only in the Song Play mode or when the "4. GUIDE Demo" song is selected in the Demo mode. Only one Guide mode can be selected at a time.

### NOTE

#### Piano Roll On/Off

The piano roll display can be turned on or off from the SONG PLAY [GUIDE MODE] display (display page 5). (See page 109.)

### NOTE

The correct melody plays back no matter which note you play in the EASY PLAY mode.

### NOTE

The Guide method can be changed during playback. However, the Guide method cannot be changed for songs in which SPECIAL is indicated in the GUIDE MODE location in SONG PLAY [GUIDE MODE] (display page 5).

### NOTE

The [PAUSE] button cannot be used in the Next Note or Sound Repeat methods.

### NOTE

- The keyboard guide lamps light corresponding to the notes played by the 1/RIGHT and 2/LEFT parts during song playback, even when Guide is set to off - unless the LAMP button is turned off in the SONG PLAY [GUIDE MODE] display. The guide lamps indicate the notes to be played by both the 1/RIGHT and 2/LEFT parts when both are turned on or off; when only one of the parts is turned off, the lamps indicate the notes to be played by the part that is turned off.
- The guide part can be selected, the piano roll and guide lamps can be turned on and off, and the Guide function itself can be turned on or off during playback.

**NOTE**

- Playback tempo can be set to any desired value after a song has been selected by using the TEMPO [-] and [+] buttons.
- The Guide function may not work properly with software which was not produced for independent left- and right-hand playback.
- Since the Guide phrases used in the Sound Repeat method are automatically determined by the Clavinova, they may not precisely match the actual musical phrases. Also, the phrases may become shorter when the Guide function is used for both the left- and right-hand parts.

## Other Guide-related Functions

Various settings related to the Guide functions can be made in the SONG PLAY [GUIDE MODE] display (display page 5).

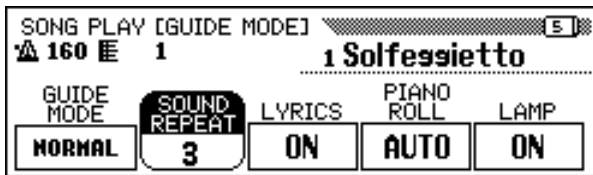

**NOTE**

The settings made in this display will also be effective in the Guide function during playback of the "4. GUIDE Demo" song in the Demo mode.

### GUIDE MODE

**NORMAL** is usually displayed as the setting of the **GUIDE MODE** function in the SONG PLAY [GUIDE MODE] display. Change the setting to **ENSEMBLE** by pressing the **GUIDE MODE** button; the part which was set to Part Cancel in the SONG PLAY [MAIN] display (display page 1) can then be played with the regular Part Cancel function and the other part (not set to Part Cancel) can be played with the Easy Play function.

When Next Note is selected and **SPECIAL** is indicated in the **GUIDE MODE** display, a special Guide method is engaged for the selected song. To return the normal Next Note mode, press the **GUIDE MODE** button so that the indication changes to **NORMAL**.

**NOTE**

- The **ENSEMBLE** mode is effective only for songs which have data in both the [1/RIGHT] and [2/LEFT] parts.
- The **ENSEMBLE** mode cannot be used when Next Note or Sound Repeat is selected.
- The **GUIDE MODE** setting can only be changed when playback is stopped at the beginning of a song.

**NOTE**

- The **SPECIAL** indication appears automatically depending on the song being played back. The **SPECIAL** indication will not appear, even when pressing the **GUIDE MODE** button, when playing back songs that do not feature the special method.
- When using the Easy Play or Sound Repeat method, the respective method is still active, even if the **SPECIAL** indication is shown.

**NOTE**

**GUIDE MODE**

- Settings: **NORMAL**, **ENSEMBLE**, (**SPECIAL**)
- Basic setting: **NORMAL** or **SPECIAL** (depends on song)

## ■ Setting the Sound Repeat Number .....

To set the number of times the phrase is repeated in the Sound Repeat mode, press the **SOUND REPEAT** button. When **AUTO** is selected, only the notes which have not been played correctly are repeated; the Guide function will automatically go on to the next phrase once the previous one has been played properly.

## ■ Lyric Display ON/OFF .....

To turn lyric display off, press the **LYRICS** button to set the function to OFF.

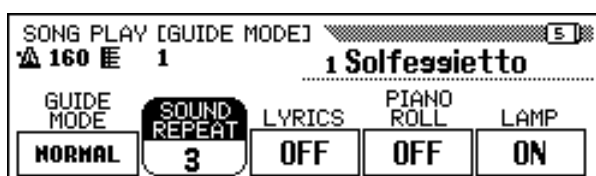

## ■ Piano Roll ON/OFF .....

The piano roll display can be turned on or off by pressing the **PIANO ROLL** button. When **AUTO** is selected, the piano roll will appear by turning on one of the GUIDE CONTROL buttons. When this function is set to **ON**, the piano roll is always shown during playback; when it is set to **OFF**, the piano roll is not displayed.

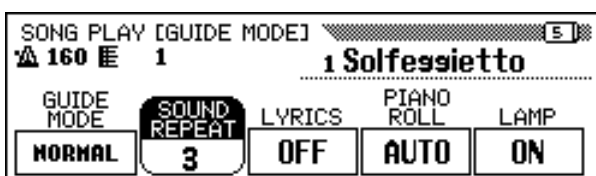

## ■ Keyboard Guide Lamp ON/OFF .....

To turn off the keyboard guide lamps, press the **LAMP** button to set the function to OFF.



### SOUND REPEAT

- Settings: AUTO, 2 — 10
- Basic setting: AUTO



The **SOUND REPEAT** setting can only be changed when playback is stopped at the beginning of a song.



### LYRICS

- Setting: ON, OFF
- Basic setting: ON



- The Lyric Display function cannot be used with song data recorded in SMF format 1.
- If a song does not contain lyric data, the LYRICS function will display a row of dashes (- - -). The LYRICS function cannot be selected when playing back such songs.



### PIANO ROLL

- Settings: AUTO, ON, OFF
- Basic setting: AUTO



When a song contains lyrics, the Lyric Display function has priority over the Piano Roll function. The Piano Roll will be displayed if you turn the Lyric Display function off as described above.

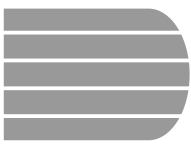

# Song Recording.....

The Clavinova features comprehensive song recording functions that allow you to record your own performances to floppy disks. Three recording methods are available: Quick Recording (page 112), which lets you record quickly and easily; Track Recording (page 115), with which you can record multiple instrumental parts; and Chord Sequence (page 121), which lets you step-record Auto Accompaniment chords.



NOTE

- Up to 60 songs can be recorded on a single disk, depending on the amount of data contained in each song.
- Before you can record songs on a new disk, the disk must be formatted for use by the Clavinova (see page 111).

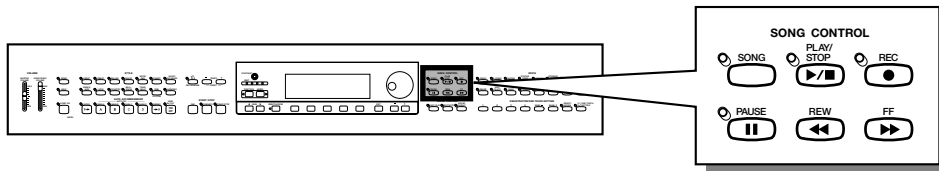

## ● Structure of a Song

A song can be made up of several instrumental parts, each assigned to a different track, as shown in the example below.

Sample song track chart

Track	Part
1	Piano (right-hand)
2	Piano (left-hand)
3	Bass
4	Strings
:	:
9	Rhythm
10	Rhythm
:	:
16	Organ

(Up to a maximum of 16 tracks.)

Various confirmation, alert, and error messages may appear in the display during operation. Refer to “Messages” (page 165) for information on the messages.



NOTE

- Refer to “Handling the Floppy Disk Drive (FDD) and Floppy Disks” (page 9) for information on using floppy disks.
- Songs recorded by the CVP-103 are saved as SMF (format 0) files. Songs recorded using the [XG] category voices are XG-compatible. See page 172 for information on the XG/SMF (format 0) format.

## Recording Setup: Disk Format

Before you can record to the included blank disk, you will have to format it. Commercially available blank disks must also be formatted for use. You can use the Format function in the FUNCTION [DISK 5] display (page 146) to re-format floppy disks that have already been used for recording.

### 1 Insert a disk.....

Gently insert the included blank disk for recording into the disk drive face-up and shutter end first, until it clicks into place.

- A few seconds after inserting the disk into the disk drive, a "Start disk format?" message appears in the display. To start formatting, press the **OK** button. To cancel the format operation, press **CANCEL**.

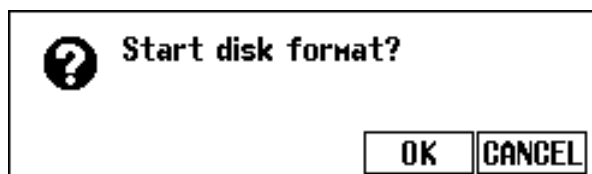
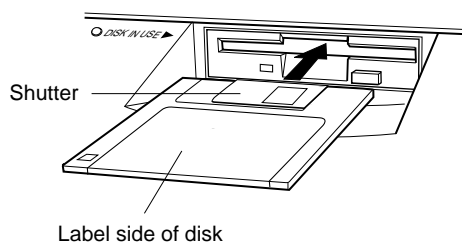

**NOTE**

The same display appears when inserting blank unformatted disks, or disks of different formats.

**NOTE**

**Format Types**

2DD disks are formatted to 720 KB, while 2HD disks are formatted to 1.44 MB.

### 2 Execute the format operation.....

An "Are you sure?" message appears in the LCD display; press **YES** to execute the operation, or **NO** button to cancel it.

A bar graph appears in the LCD display during formatting to indicate progress of the operation. The display automatically returns to the previous display when formatting is completed.

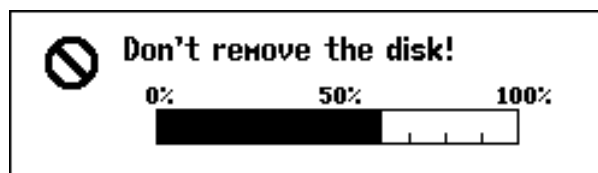
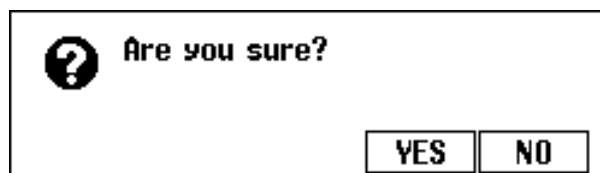

## Quick Recording

### 1 Insert a formatted disk.

Make sure that the disk's write protect tab is set to the "write" position, then insert the disk face up with the shutter forward until it clicks into place.

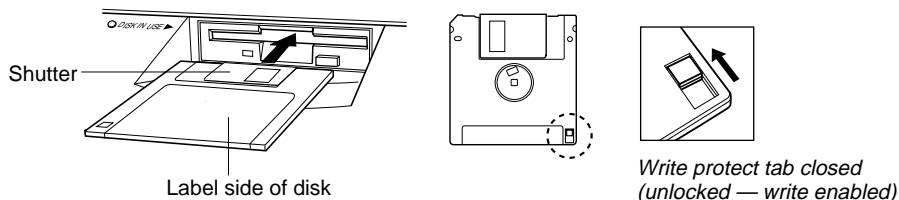

- ➔ The DISK IN USE lamp stays lit until the Clavinova reads and recognizes the disk.
- If the Song Play mode is not automatically called up, press the [SONG] button.
- ➔ The lamp lights and the SONG PLAY [MAIN] display appears. If the SONG PLAY [MAIN] display is not shown, use the PAGE [◀] and [▶] buttons to select display page 1.

### 2 Select the song number to be recorded.

Select the **SONG** function, then use the **SONG** button, the data dial, or the [-] and [+] buttons to select the desired song number for recording.

- Select a song number between 1 and 60.

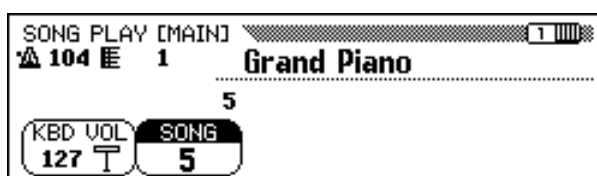

The selected number is the location where the song will be recorded. If a song name appears beside the song number, the selected song already contains data. Make sure that it doesn't contain data you want to keep before moving on to the next step! If you record to a song that contains data, the existing data will be replaced by the new data.

#### NOTE

The Song Play mode is not automatically engaged if the disk is inserted when one of the disk-related FUNCTION displays (page 139) or the CUSTOM STYLE display (page 74) is showing.

#### NOTE

##### Using Style File Disks

When using Style File disks, first load the desired data from the Style File disk (page 86), then insert the recording disk.

#### NOTE

If you select a song number between 61 and 99, you will not be able to select the Song Record mode in step 3. The Clavinova can play back up to 99 songs on a single disk, but it can only record songs in song numbers up to 60.



## 3 Select the Song Record mode. ....

Press the [REC] button.



- ➔ The [REC] lamp lights and the QUICK RECORD display (Record mode page 1) appears.



Call up page 1 by using the PAGE [◀] and [▶] buttons if the lamp is lit but the QUICK RECORD display is not shown.

Once you have entered the Record Mode, you can press [REC] or [EXIT] at any time before step 6 to cancel recording without saving any data.

## 4 Select the part to be recorded. ....

In Quick Recording, three parts can be recorded: the right hand part (1/RIGHT), the left hand part (2/LEFT) and the Auto Accompaniment & rhythm part (ACMP&RHY). Press the appropriate button — **1 / RIGHT**, **2 / LEFT** or **ACMP&RHY** — to set the corresponding part to **REC** (recording enabled) or **OFF** (recording/playback disabled). The **PLAY** (playback) setting can be selected only for parts which already contain data.

The **ACMP&RHY** part can be set to **REC** automatically by pressing the panel [ACMP ON] button. To record only the rhythm, leave **ACMP&RHY** set to **REC**, then press the [ACMP ON] button so that the lamp goes out.



When a part is set to **REC** (recording enabled), the Synchronized Start function is set to stand-by, and recording automatically starts when you play the keyboard.

### NOTE

- The song number for recording can be changed in the QUICK RECORD display.
- If the Auto Accompaniment is turned on when you enter the Record mode, the ACMP&RHY track will automatically be set to REC.

### NOTE

#### Songs Recorded on Other Instruments

- The Clavinova may display the "Convert to CVP song?" message (page 166) if you attempt to record data to a song created on another instrument. Press YES to convert the song before recording.
- When a song is converted as described here, it may not be possible to record data in tracks other than tracks 1 or 2.

### NOTE

Both 1/RIGHT and 2/LEFT cannot be set to REC at the same time.

### NOTE

#### Recording the Harmony Parts

The Clavinova will record harmony notes when you record with the Harmony function (page 69) turned on. If the harmony type is set to Duet, Trio, Block, 4 Part, Country, Octave, or 1+5, the harmony notes will be recorded in the selected track. When any other harmony type is selected, the harmony notes will be recorded in tracks 6 through 8.

### NOTE

#### Recording in Dual/Split Mode

- If you record the 1/RIGHT part in the Dual mode, data is recorded to tracks 1 and 3.
- If you record the 1/RIGHT part in the Split mode, data is recorded to tracks 1 and 5.
- If you record the 2/LEFT part in the Dual mode, data is recorded to tracks 2 and 4.
- If you record the 2/LEFT part in the Split mode, data is recorded to tracks 2 and 5.
- When the recording part is changed, [HARMONY] and [SPLIT] are automatically turned off.

### NOTE

#### Recording the Auto Accompaniment

- When recording Auto Accompaniment, the rhythm is recorded to tracks 9 through 10, bass to track 11, and chordal backing to tracks 12 through 16.
- The Chord Sequence function (page 121) lets you record the Auto Accompaniment without having to play chord parts in tempo.

### NOTE

- When any part is set to REC, the remaining capacity of the disk (in kilobytes) is shown to the right of the tempo indicator in the display. Empty 2DD and 2HD disks should have about 690 KB (about 69,000 notes) and 1400 KB (about 140,000 notes), respectively.
- When the ACMP&RHY part is set to REC, the metronome will sound to provide a timing guide before recording is started.

## 5 Select the desired voices and style, etc. ....

Select the voices and accompaniment style and set the tempo in the normal way, and other settings needed. (If you want to try out the selected voices, style, tempo, or other settings, be sure to do so before entering the Song Record mode in step 3, since the recording will start as soon as you play the keyboard or press the [START/STOP] button.)

## 6 Start recording. ....

Start playing the keyboard or press the [PLAY/STOP] button. To record the Auto Accompaniment parts, start the Auto Accompaniment in the usual way (page 58), and finger chords in a manner appropriate to the current accompaniment mode (pages 60 and 61).

### NOTE

#### **When Using Style File Disks**

When using Style File disks, make sure to load the data from the Style File disk (page 86) before inserting the disk for recording.

### NOTE

The Auto Accompaniment sections — INTRO, AUTO FILL, ENDING, and FADE IN/OUT — can be also recorded. Press the INTRO button before starting to record, the AUTO FILL buttons while recording, the ENDING button at the end of recording, and the FADE IN/OUT button at the beginning or ending of the recording. When the ENDING button or the FADE IN/OUT button is pressed at the ending, recording stops automatically after the ending pattern or fade out.

### NOTE

#### **Recording Along with the Metronome**

1. After selecting the voice, press the [METRONOME] button, and set the Beat parameter in the METRONOME display. →The metronome will start sounding.
2. The recording starts as soon as you play the keyboard. The metronome sound is not recorded.

#### **When a disk is not inserted...**

- A song can be recorded to internal memory if it is short enough. A maximum of approximately 2500 notes (26 KB) can be recorded; however, the amount may be less if other functions are used. The internally recorded song will be deleted when the power is turned off or when another song is loaded. See "Recording Without a Disk" (page 133) for more information.

### NOTE

#### **Adjusting the Volume While Recording**

You can use the [ACMP/SONG VOLUME] slider and the MIXER display to adjust the volume of the Auto Accompaniment part while recording. Adjust the keyboard part volume using the KBD VOL function in the display.

### NOTE

#### **If You Turn the Harmony Function or Split Mode On While Recording...**

- You can record harmony notes or left range keyboard part while recording the 1/RIGHT part.
- When the 2/LEFT part is being recorded, the Clavinova will not record the harmony notes for harmony types that are recorded to tracks 6 through 8 (see the sidebar on page 113), or the left range keyboard part.

### NOTE

The keyboard guide lamps do not light up during recording.

**7 Stop recording.** .....

Press the [PLAY/STOP] button.

- ➔ Recording stops. When the recorded data has been written to disk, the [REC] lamp goes out and the SONG PLAY display appears.

If you press the [START/STOP] button, only the recording of the Auto Accompaniment or rhythm will stop. You can continue recording your keyboard performance, without the Auto Accompaniment and rhythm. Press the [PLAY/STOP] button in order to actually stop recording.

If you stop the style by pressing the [ENDING] button or the [FADE IN/OUT] button, the Clavinova will stop recording the keyboard as well.

**8 Play back the recording.** .....

Press the [PLAY/STOP] button.

- ➔ The recorded data will be played back.

During playback you can use the [REW], [FF] and [PAUSE] buttons to control the playback, and use the TEMPO [-] and [+] buttons to change the tempo. You can also play along on the keyboard.

Playback will stop automatically when the end of the recording is reached, or you can press the [PLAY/STOP] button again to stop it at any time.

**CAUTION**

The Clavinova may continue to write data to the disk for a short time after you stop recording. **DO NOT** eject the disk while the DISK IN USE lamp of the disk drive is lit.

**NOTE**

- When a song has been recorded, the temporary name SONG \*\*\* (\*\* is the number) will automatically be given to the song. You can change the name as desired. (See page 127.)
- The [ACMP ON] lamp automatically goes out when recording of these parts has finished.
- When recording is finished, the song volume is automatically reset to the maximum setting, regardless of the current [ACMP/SONG VOLUME] slider position.

**NOTE**

- When style changes have been recorded in a song, playback may become slightly sluggish at points where the style changes, depending on the styles that were used.
- Playback of songs recorded using both the Dual mode (page 33) and the Full Keyboard accompaniment mode (page 57) may also sound somewhat sluggish.

**Track Recording (Multi-track Recording)**

**1 Set up the instrument for recording.** .....

The first three steps in the Track Recording process are exactly the same as those for Quick Recording. (See page 112.)

**2 Select the TRACK RECORD page** .....

Use the PAGE [◀] and [▶] buttons to select the TRACK RECORD page (Record mode display page 2).

The 16 tracks appear above the TRACK ◀ and ▶ buttons. Tracks which are enabled for playback are indicated by a box surrounding the track number, and tracks which are record-enabled are indicated by a highlighted number. The numbers of tracks that do not contain data are not displayed.

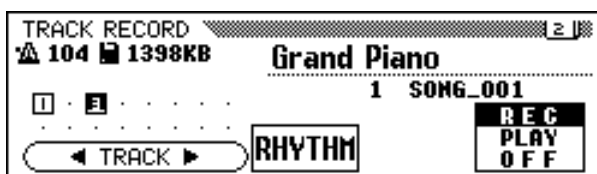

## 3 Select the desired track for recording. ....

Press the **TRACK** ◀ and ▶ buttons or use the data dial or [-] and [+] buttons to select the track.



→ The selected track is indicated by an underline mark.

Use the rightmost LCD button to set the selected tracks to **REC** (recording enabled) or **OFF** (recording/playback disabled). When a track is set to **REC**, the Synchronized Start mode is turned on. The Clavinova will start recording when you begin to play on the keyboard.

**PLAY** can only be selected for tracks which contain data. When a track is muted, the track number is displayed without a surrounding box.

Three separate tracks can be set to record simultaneously when recording keyboard parts.

If you intend to record using the Dual or Split functions, two tracks must be record-enabled.

If you intend to use both the Dual and Split functions simultaneously, three tracks must be selected.

If the Auto Accompaniment and/or Harmony are turned on, the recording track numbers are automatically fixed, as described below.

- \* If the Auto Accompaniment is turned on, tracks 9 through 16 are automatically set to record the Auto Accompaniment data. If the Harmony function is turned on and a harmony type (page 70) other than **Duet, Trio, Block, 4 Part, Country, Octave**, or **1+5** is selected, tracks 6 through 8 are automatically set to record the Harmony data.

When the **RHYTHM** button is pressed, tracks 9 and 10 are automatically selected for the rhythm data. Set tracks 9 and 10 to **REC**, **PLAY**, or **OFF** using the rightmost LCD button.

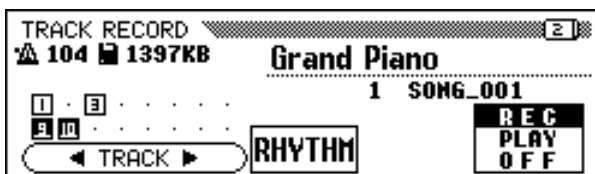

### NOTE

- Track 10 (and 9, in some cases) can only be used to record the rhythm sound of the accompaniment style and cannot be used to record keyboard part. Also, the keyboard part should be recorded on a track other than those used for Harmony or Auto Accompaniment.
- When the RHYTHM tracks (9 and 10) or the Auto Accompaniment tracks (9 through 16) are set to REC, the metronome will sound to provide a timing guide.
- If the Auto Accompaniment and/or Harmony are already on when the Track Recording page is selected, the corresponding tracks are automatically record-enabled.

**4 Set all performance features as required.** .....

After setting the tracks to be recorded, set up all necessary performance features as required: voice, accompaniment style, tempo, reverb, etc.

**5 Start recording.** .....

Start playing the keyboard or press the **[PLAY/STOP]** button. To record the Auto Accompaniment parts, start the Auto Accompaniment in the usual way (page 58), and finger chords in a manner appropriate to the current accompaniment mode (pages 60 and 61).

The current measure number is shown in the display as you record. The parameters listed below will be recorded in addition to notes you play. (Recorded parameters differ depending on the play styles and settings.)

**Parameters Recorded for Each Track**

- Notes
- Voice
- Keyboard volume
- Pan
- Right (damper) pedal
- Left pedal (page 138)
- Center (sostenuto) pedal
- Reverb depth
- Chorus depth
- Effect depth
- Keyboard part volume (main, second, left)
- Fade-in/out (converted into volume data)
- Scale tuning data (page 155)

**Other Recorded Parameters**

Accompaniment style data which is recorded but not listed above includes:

- Accompaniment part volume (volume settings included in style data, plus mixer levels set when recording)

**NOTE**

*If you want to re-record part of the song (for example, if you've made a mistake in the recording), you can easily do so with the Punch-in/out Recording function (page 118).*

**NOTE**

**Backing Up Your Data**

*Any time you have recorded some amount of data, you should copy the data to another song number for backup purposes (see page 142 for information on the Copy operation). Doing this prevents accidental loss of important data, should you inadvertently delete the data while recording.*

**Parameters Recorded for the Entire Song**

- Tempo
- Reverb type
- Overall reverb depth
- Chorus type
- Effect type\*
- Accompaniment style
- Section (Intro, Main A through D, Fill-In, Ending)

\* The last recorded track effect takes priority.

## 6 Stop recording.

Press the [PLAY/STOP] button.

- ➔ Recording stops. The [REC] lamp goes out when the data has been written to the disk, and the SONG PLAY display appears.

If you press the [START/STOP] button, only the recording of the Auto Accompaniment or rhythm will stop. You can continue recording your keyboard performance without the Auto Accompaniment or rhythm. Press the [PLAY/STOP] button in order to actually stop recording.

If you stop the style by pressing the [ENDING] button or the [FADE IN/OUT] button, the Clavinova will stop recording the keyboard as well.

### NOTE

When recording is finished, the [ACMP/SONG VOLUME] level is automatically set to the maximum value, regardless of the current slider position.

## Adding New Tracks

You can add a new track to your song by selecting a new record track(s) and voice(s) for recording as described above. You can also play back and monitor the previously recorded tracks while you record. By repeating this process, you can assemble a complete song.

### NOTE

If you record on a track that has already been recorded, the previous material will be erased and the new material will be recorded in its place.

## Punch-in/out Recording

With the Punch-in/out Recording function, you can selectively re-record specified sections of the song. Punch-in/out recording allows you to start recording from any “punch-in” point within a previously recorded track and stop recording at any “punch-out” point, leaving intact all recorded material up to the punch-in point and following the punch-out point.

### NOTE

Punch-in/out recording cannot be performed on tracks which have been used to record the Auto Accompaniment or rhythm parts, or on tracks 6 through 8 when these tracks have been used to record harmony parts (see sidebar on page 113).

## 7 Play back the song.

Play back the song in order to locate the point where you want to punch in (i.e., start re-recording).

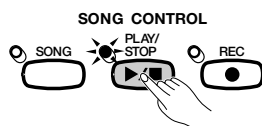

## 2 Pause before the punch-in point. ....

Press the [PAUSE] button to pause play back a bit before the point at which you want to start recording. Leave a measure or more before the punch-in point so you'll be able to grasp the timing before you punch in.



## 3 Turn on the Punch-in/out function. ....

Press the [REC] button.



→ The PUNCH IN/OUT display appears.



## 4 Select a track. ....

Press the **TRACK** ◀ or ▶ buttons or use the data dial or [-] and [+] buttons to select the track.

→ The selected track is indicated by an underline mark.

Use the rightmost LCD button to set the selected track to **REC** (recording enabled) or **OFF** (recording/playback disabled). **PLAY** can only be selected for tracks which contain data. When a track is muted, the track number is displayed without a surrounding box.

### NOTE

#### Auto Setting of Punch-in/out

If no other track is selected, the last recorded track is automatically selected for Punch-in/out.

### NOTE

If you select a track that was used to record an Auto Accompaniment or rhythm part, or a track (6, 7, or 8) that contains a harmony part (see sidebar on page 113), you will not be able to set the track to REC.

## 5 Select the punch-in mode.....

Select the desired punch-in mode with the fourth LCD button. Two modes are available, as described below.

<b>1ST KEY</b>	Recording begins as soon as the first key is played, after Punch-in playback is started in step 7 (below).
<b>PEDAL</b>	Recording begins as soon as the left pedal is pressed, after Punch-in playback is started in step 7 (below).



## 6 Select the punch-out mode.....

Select the desired punch-out mode with the center LCD button. Two modes are available, as described below.

<b>REPLACE</b>	When recording is stopped, all data following the punch-out point will be erased.
<b>PCH.OUT</b>	When recording is stopped, all data following the punch-out point will remain intact.



## 7 Start playback and recording.....

Press the [PLAY/STOP] or [PAUSE] button to start playback from the current paused location.

To punch in (i.e., start recording) when the **1ST KEY** mode is selected, simply begin playing at the point from which you want to record.

To punch in (i.e., start recording) when the **PEDAL** mode is selected, press the left pedal at the point from which you want to record.

## 8 Stop recording.....

Press the [PLAY/STOP] button.

- ➔ Recording stops. When the data has been written to disk, the [REC] lamp goes out and the SONG PLAY display reappears.

### NOTE

When the **PEDAL** punch-in mode is selected, the left pedal is automatically assigned for this function only (the normal pedal function is canceled).

### NOTE

When the **PEDAL** Punch-in mode is selected, recording can be started directly by pressing the left pedal, without first pressing the [PLAY/STOP] or [PAUSE] button to start playback.

### NOTE

When the **PEDAL** mode is selected, recording can also be stopped by pressing the left pedal.





# Chord Sequence.....

The Chord Sequence function lets you enter Auto Accompaniment data step-by-step according to chord names. You can use this function to record the accompaniment part without having to play the song in time with the rhythm or at a certain tempo.

## 1 Set up the instrument for recording.....

Just as you did in steps 1 through 3 of Quick Recording, insert a formatted disk, select a song number, then press the [REC] button to enter the Record mode.



➤ Select the RECORD EDIT display (page 3 of the Record mode display) by using the PAGE [◀] and [▶] buttons.



## 2 Turn on the Chord Sequence function.....

Press the **CHORD SEQ.** button in the RECORD EDIT display.



### NOTE

You cannot use the Music Database (page 67) or the Registration function (page 89) while recording data with the Chord Sequence function.

### NOTE

**When Chord Sequence cannot be turned on...**

The chord sequence function cannot be used when no disk has been inserted in the disk drive.

# Chord Sequence

- The CHORD SEQUENCE display appears, the Auto Accompaniment is turned on, and the Fingered 1 accompaniment mode is selected.

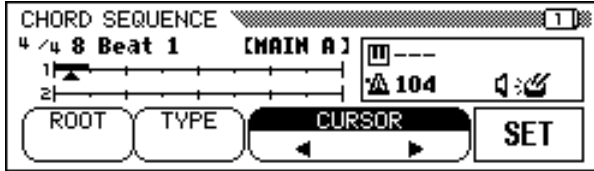

### 3 Move the cursor to the entry point.

The display shows measures as a horizontal line with 8th-note divisions.

To move the cursor along the measure indication to the point at which you want to enter a chord or style change, press one of the **CURSOR** ◀ or ▶ buttons to highlight the function, then use the data dial or [-] and [+] buttons.

You can also move the triangular cursor by pressing the **CURSOR** ◀ and ▶ buttons.

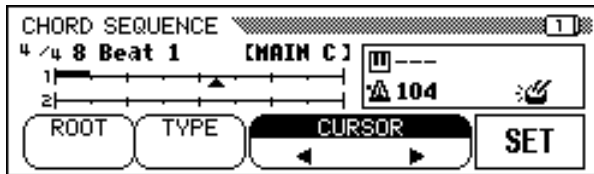

#### NOTE

#### Changing the Auto Accompaniment Mode

Auto Accompaniment cannot be turned off while the Chord Sequence function is active. However, you can select an accompaniment mode (other than Full Keyboard) in the ACCOMPANIMENT MODE display by pressing [DIRECT ACCESS] followed by the [ACMP ON] button. The split point can also be changed in this display.

#### NOTE

- The Chord Sequence data will automatically replace any previous data in the Auto Accompaniment and rhythm tracks that was recorded in the Quick Record or Track Record modes.
- Up to 999 measures can be recorded using the Chord Sequence function.
- The chord input resolution will be automatically selected according to the current style. For styles with 2/4, 3/4, 4/4, and 5/4 time signatures, one chord can be entered on every 8th note or 8th-note triplet. For other time signatures, one chord can be entered for each measure.

#### NOTE

#### Entering Accompaniment Style and Section Changes

One style change or section change (page 123) can be made at the beginning of each measure (The Intro pattern can only be entered at the beginning of a song.). However, Auto Fill data can be entered anywhere you desire.

#### NOTE

#### Adjusting the Volume of Auto Accompaniment

You can also enter volume changes for the Auto Accompaniment. Used judiciously, these can help you create professional-sounding dynamic changes in the Auto Accompaniment of your song. To do this, first enter the Auto Accompaniment part volume data from the MIXER display; the volume event symbol (🔊) will appear in the box at the right side of the display. To actually record the volume data at the current position, press the SET button in the CHORD SEQUENCE display. (An initial volume event is automatically entered at the beginning of a song.)

## 4 Enter and set the chords and/or style changes.....

To enter a chord, either play the chord with appropriate fingering in the left range of the keyboard (lower than the split point), or highlight **ROOT** or **TYPE** in the LCD display and use the data dial or [-] and [+] buttons.

You can also select the chord by pressing the **ROOT** and/or **TYPE** buttons.

- ➔ The name of the chord is displayed next to the keyboard icon in the box at the right side of the display.
- To enter a style change (style, section and tempo) simply make the appropriate selections in the normal way.
- Once the chord and/or style has been selected, press the **SET** button.
- ➔ A black box appears above the line at the current position in the measure indicator, indicating that the data has been recorded at that position. The cursor automatically moves to the next position.

The recorded data is also shown in the display: the time signature, style name, and section appear at the upper left, and the chord name and tempo in the box at the right side of the display.

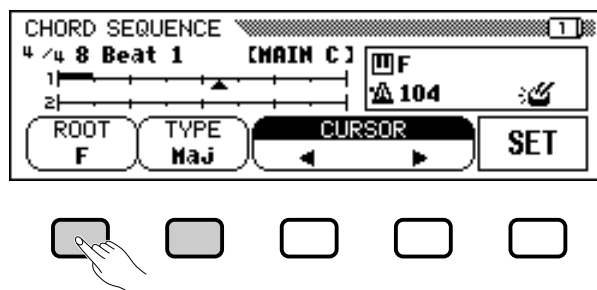

Continue moving the cursor to other positions and enter chords and style changes in this manner. You can always check the entered data during the operation by playing back the sequence using the [PLAY/STOP] button.

The data recorded by the Chord Sequence function is listed below.

### Data Recorded by the Chord Sequence Function

- Accompaniment style
- Section (MAIN A/B/C/D, Intro, Ending, Auto-fill, Fade-in/out, Break)
- Chord name
- Tempo
- Auto accompaniment part volume (MIXER settings)
- Rhythm on/off
- ACMP/SONG volume (as an initial setting only)

#### NOTE

The names of chords entered using the keyboard are also displayed by the **ROOT** and **TYPE** functions.

#### NOTE

A fade-out cannot be entered during a fade-in.

#### NOTE

#### Entering Rhythm-only Sections

You can also record the rhythm alone (without accompaniment) to your song. To do this, record a blank chord in the desired measure by leaving the **TYPE** function set to “---”.

#### NOTE

#### Entering a Break

- A complete break can be created by setting the chord type to “---” and setting the rhythm sound to “OFF” (see “RHYTHM ON/OFF” below).
- The “break fill” pattern triggered by the left pedal (page 138) cannot be entered using the Chord Sequence function.
- The Clavinova will normally play a fill-in pattern as it switches between variations (MAIN A through MAIN D). To have the Clavinova change the style variation at the start of a measure without playing a fill-in pattern, press the button for that variation twice before pressing **SET**.

#### NOTE

- The measure number is shown to the left of the measure indicator.
- For information on other useful editing features, see “Other Chord Sequence Functions,” below.
- The same chord cannot be entered twice in a row. If the chord displayed by the **ROOT** and **TYPE** functions is the same as the last chord that was recorded, the Clavinova will not record a chord change when the **SET** button is pressed.

# Chord Sequence

## 5 Stop recording.

When all recording has been finished, select page 2 of the CHORD SEQUENCE display, then press the **END MARK** and **SET** buttons and input an “end mark” which determines the location of the ending. The end mark will be displayed in the box at the right side of the display.

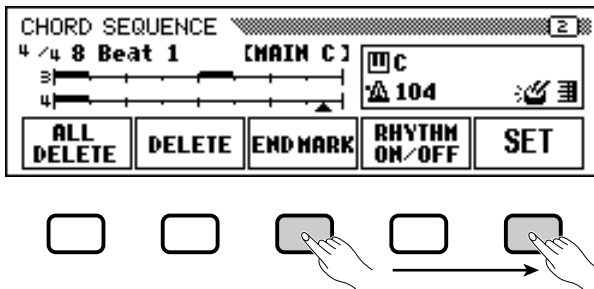

Finally, press the **[REC]** button; the “**Save recorded data?**” message will appear. Press **YES** to store the recorded data and automatically leave the Chord Sequence function; the display returns to the SONG PLAY display. To leave without saving the data, press **NO**. To continue editing the sequence without saving the data, press **CANCEL**.

### NOTE

- The chord sequence data now resides in tracks 9 through 16, and can be played back in the normal way. Add other tracks as desired by using the standard track selection and recording procedure. You can also record over the Auto Accompaniment parts and replace them with original material if you like by using the standard track selection and record procedure.
- The song recorded via the Chord Sequence function can be modified later by re-entering the Chord Sequence mode and making the desired changes. However, keep in mind that any data recorded over the Auto Accompaniment parts (with normal track recording) will be replaced by the preset accompaniment style data. (For example, even if you've recorded your own bass part, it will be erased and replaced by the original bass pattern if you correct the data in the Chord Sequence display.)

## Other Chord Sequence Functions

Page 2 of the CHORD SEQUENCE display contains a number of versatile functions that help you enter chord sequence data more efficiently.

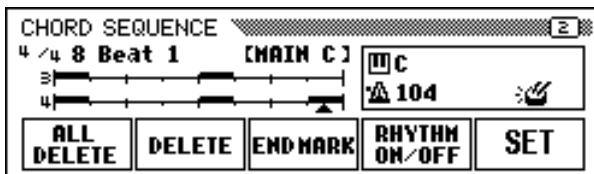

### ■ ALL DELETE

To delete all sequence data, press the **ALL DELETE** button. An “**Are you sure?**” message is displayed. Press **YES** to execute the operation, or **NO** to cancel.

### ■ DELETE

To delete the data at the current cursor location, press the **DELETE** button. An “**Are you sure?**” message is displayed. Press **YES** to execute the operation, or **NO** to cancel.

■ **END MARK** .....

To enter an “end mark” at the current cursor location, press the **END MARK** button followed by the **SET** button. An end mark signifies the end of the song, and should always be entered to properly end each song. (An end mark is unnecessary when ending with an Ending pattern or Fade-out.) The cursor cannot be moved past an end mark. You can delete an end mark by using the **DELETE** button, just as with other normal data.

■ **RHYTHM ON/OFF** .....

To turn the rhythm sound on or off, press the **RHYTHM ON/OFF** button followed by the **SET** button. No rhythm sound is produced following the location to which a “rhythm off” event is entered; the rhythm starts sounding again from the location to which a “rhythm on” event is entered.

 **NOTE**

**End Mark**

*Unless an end mark is entered, the song will end one measure after the last entered data. If an Ending pattern or Fade-out is input, the song will end at the last measure of the Ending or Fade-out.*

 **NOTE**

*The rhythm on/off status is displayed in the box at the right side of the display.*

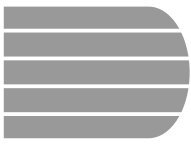

# Other Record Edit Functions.....

The Record mode has a number of other convenient editing functions that provide even greater control over the song data. The Record Edit functions include: Setup Memory, which lets you save the Clavinova's current panel settings as part of the currently selected song; Song Name, which lets you name a recorded song file; Track Edit, which gives you a variety of track-related editing controls, such as Track Mix and Track Delete; and Initial Edit, which lets you change the data at the beginning of a song, such as voice, reverb, and effect settings.

You can select the Record Edit functions from the RECORD EDIT display (Record mode display page 3) after selecting the song you wish to edit.

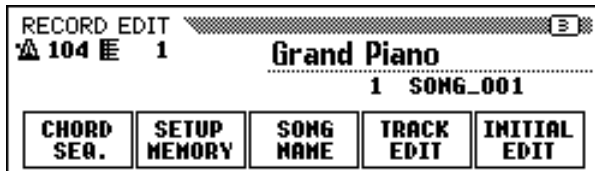

## Setup Memory

The Setup Memory function lets you save the current panel settings to disk so that they will automatically be restored whenever you play back the song being edited.

### 1 Set up the Clavinova to play the song.....

Change the Clavinova's functions to the settings you want it to use when playing back the song you're editing.

### 2 Select the Setup Memory function.....

Use the PAGE [▶] button to select the RECORD EDIT display (page 3 of the Song Record mode display) if necessary, then press the **SETUP MEMORY** button.

→ The "Save panel settings to disk?" message is displayed.

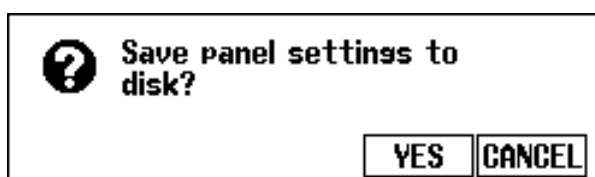

#### NOTE

- For details regarding which settings are saved by the Setup Memory function, see the Parameter Chart on page 13 of the Reference Booklet.
- The settings saved by the Setup Memory function will be deleted if you re-record the song data or use Initial Edit function (page 130) to edit the initial parameter settings.

- Press **YES** to save the current panel setup, or **CANCEL** to return to the RECORD EDIT display.
- ➔ The Clavinova displays the “**Don’t remove the disk!**” message and bar graph as it saves the data to the disk, then displays a “**Completed!**” message before it returns to the RECORD EDIT page.

## Song Name

This function is used to name song files recorded with the Clavinova or to change existing names. To call up the Song Name function, press the **SONG NAME** button in the RECORD EDIT display.

**NOTE**

*The Song Name function cannot be used when a disk has not been inserted in the disk drive.*



### 1 Enter the desired name. ....

Use the ► button to move the underline cursor to the desired character position in the file name display. (File names can be up to 12 characters in length).

- Use the data dial or [-] and [+] buttons to select and highlight the character or mark you wish to enter.

Press the **CH.SET** button to enter the selected character to the current cursor position and move to the next position. Continue entering other characters or marks in this way.

To delete the character at the previous position, press the **BACK** button. The character before the underline cursor is deleted and the cursor moves back to the deleted position.

To abort the Song Name operation and return to the RECORD EDIT display, press the **CANCEL** button.

### 2 Register the name. ....

When the song file name is complete, press the **OK** button to register it. The new name is registered as the current song file name. To cancel the operation, press the **CANCEL** button.

## Track Edit

Press the **TRACK EDIT** button in the RECORD EDIT display to call up the TRACK EDIT display. There are three pages in the TRACK EDIT display: TRACK EDIT [MIX], TRACK EDIT [DELETE], and TRACK EDIT [QUANTIZE].

### ■ Track Mix (TRACK EDIT page 1)

The Track Mix function combines the data from two specified tracks and copies the result to a third specified track.

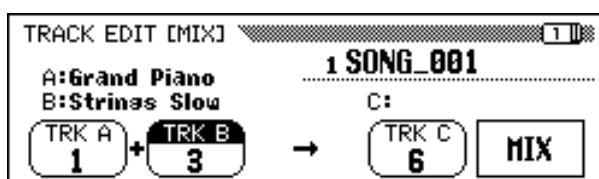

#### 1 Specify the two tracks to be mixed. ....

Press the **TRK A** and **TRK B** buttons to highlight the corresponding functions, and use the data dial or [-] and [+] buttons to select the numbers of the two tracks to be mixed. The voices which are used for the selected tracks are indicated above these functions in the LCD display.

#### 2 Specify the destination track. ....

Use the **TRK C** function to specify the track to which you want to record the mixed data. You can also specify the track for the mixed data by pressing the **TRK C** button to highlight the corresponding function, then using the data dial or [-] and [+] buttons.

Any previous data in the destination track will be erased.

#### 3 Execute the Track Mix operation. ....

Press the **MIX** button to begin execution of the Track Mix operation. An "Are you sure?" message is displayed. Press **YES** to execute the Track Mix operation or press **NO** to cancel.

When the operation is completed, the **MIX** function will be replaced by the **UNDO** function, allowing you to undo the Track Mix operation and restore the previous data.

Press the **[REC]** button (the lamp goes out) to exit the Track Mix function.

You can also exit the Track Mix function by pressing the **[EXIT]** button.

#### NOTE

##### Track Copy

Only tracks containing data can be selected by the TRK A and TRK B functions. In addition, "--" (no track) can also be selected for TRK B. In this case, the data in track A will simply be copied to track C.

#### NOTE

For the Track Mix function, the selected track voice and volume data, etc. (i.e., all data except note data) in track A will be effective for the destination track after the mix operation.

#### NOTE

- The original data will remain in tracks A and B after the Track Mix function is executed. If the old data is not needed, you should delete it. (See "Track Delete," below.)
- A bar graph indicating the progress of the Track Mix operation will appear while the data is being processed.
- You can check whether the results are what you expected by starting and stopping playback with the [PLAY/STOP] button. (You should try this before you do something that would make it impossible to select the UNDO function.)
- The Undo function cannot be used once you've selected another track or exited from this mode.
- The Undo feature cannot be used for data recorded to internal memory (see page 133).



## ■ Track Delete (TRACK EDIT page 2)

The Track Delete function can be used to delete the data from any specified track.



### 1 Specify the track to be deleted.....

Press the **TRACK** ▼ or ▲ button to highlight the function, then use the data dial or [-] and [+] buttons to select the track to be deleted.

### 2 Execute the Delete operation. ....

Press the **DELETE** button. When the “Are You Sure?” message is displayed, press **YES** to execute the Delete operation or **NO** to cancel.

The DELETE function will be replaced by the UNDO function after the Delete operation is executed. If the result is not what you expected, press the **UNDO** button to restore the data of the deleted track.

To exit the Track Delete function, press the [REC] button (the lamp goes out).

You can also press the [EXIT] button to exit the Track Delete function.

**NOTE**

Only tracks containing data can be selected.

**NOTE**

- A bar graph indicating the progress of the Track Delete operation will appear while the data is being processed.
- You can check whether the results are what you expected by starting and stopping playback with the [PLAY/STOP] button. (You should try this before you do something that would make it impossible to select the UNDO function.)
- The Undo function cannot be used once you've selected another track or exited from this mode.
- The Undo feature cannot be used for data recorded to internal memory (see page 133).

## ■ Track Quantize (TRACK EDIT page 3)

You can “tighten up” the timing of a recorded part by aligning all notes to specified beats with the Track Quantize function. For example, you can accurately align the recorded notes to 8th- or 16th-note resolution.



## Other Record Edit Functions

### 1 Specify the track to be quantized.

Use the **TRACK** ▼ or ▲ button to highlight the function, then use the data dial or [-] and [+] buttons to select the track to be quantized.

### 2 Specify the quantize “size.”

Press the LCD button below the note symbol to select the desired quantize “size” as shown below.

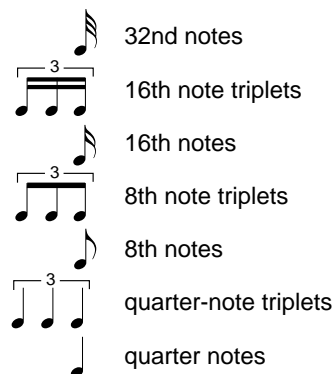

### 3 Execute the Quantize operation.

Press the **QUANTIZE** button. When the “Are you sure?” message is displayed, press the **YES** button to execute the Quantize operation or **NO** button to cancel.

The **QUANTIZE** function will be replaced by the **UNDO** function after the Quantize operation is executed. If the result is not what you expected, press the **UNDO** button to restore the data of the quantized track to what it was before performing the Quantize operation.

To exit the Track Quantize function, press the **[REC]** button (the lamp goes out).

You can also press the **[EXIT]** button to exit the Track Quantize function.

#### NOTE

Only tracks containing data can be selected.

#### NOTE

- Only the note data and voice data are quantized.
- A bar graph indicating the progress of the Quantize operation will appear while the data is being processed.
- You can check whether the results are what you expected by starting and stopping playback with the **[PLAY/STOP]** button. (You should try this before you do something that would make it impossible to select the **UNDO** function.)
- The Undo function cannot be used once you've selected another track or quantize size, or exited from this mode.
- The Undo feature cannot be used for data recorded to internal memory (see page 133).

## Initial Edit (Changing the Initial Data)

The Initial Edit function allows you to change the volume level of each track or the initial data set for the entire song after you've finished recording. The **INITIAL EDIT** display appears when you press the **INITIAL EDIT** button in the **RECORD EDIT** display. All sixteen tracks are displayed simultaneously in this display and the settings such as volume, voices and reverb depth can be changed.

#### NOTE

- Any voice changes entered in the middle of the original song will be erased when the voice parameter is changed in the Initial Edit mode.
- When editing some types of data, it will not be possible to change certain parameters (indicated as “Fixed”) or change the voices for tracks other than tracks 1 and 2.

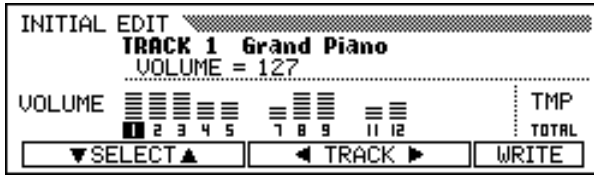

The following parameters can be changed in the INITIAL EDIT display. Refer to the indicated page for details on each parameter.

**Parameters which can be changed with Initial Edit:**

- **When track 1 — 16 is selected:**
  - VOLUME (See page 32.)
  - VOICE (See page 29.)
  - PAN (See page 32.)
  - REVERB DEPTH (See page 43.)
  - CHORUS DEPTH (See page 45.)
  - EFFECT DEPTH (See page 48.)
- **When TOTAL is selected:**
  - TEMPO (See page 25.)
  - Overall REVERB DEPTH (See page 42.)
  - REVERB TYPE (See page 42.)
  - CHORUS TYPE (See page 44.)
  - EFFECT TYPE (See page 47.)

**NOTE**

- The Program Change Number (PRG#), Bank LSB (BKL), and Bank MSB (BKM) parameters, which are used to select voices via MIDI, are displayed when VOICE is selected.

## Making Settings in the INITIAL EDIT Display

### 1 Select the track to be edited.

Select the track whose parameters you wish to change by pressing the **TRACK** ◀ or ▶ button. If **TOTAL** is selected, any changes will affect the entire song rather than an individual track.

### 2 Select the parameters to be changed.

Select the parameters to be changed by pressing the **SELECT** ▼ or ▲ button.

### 3 Change the settings.

Use the data dial or [-] and [+] buttons to change the settings. You can instantly check the effect of the changes, since the settings can be changed during playback.

**NOTE**

- If **TOTAL** is selected and the value of the reverb depth is changed, the new setting will also affect the keyboard sound.
- The voices of the tracks to which Auto Accompaniment, rhythm and/or Harmony data have been recorded, can also be changed.
- The data may not be played back accurately if you use the [REW] button while editing the data.

## Other Record Edit Functions

### 4 Write the changes.

When all the Initial Data changes have been made as desired, press the **WRITE** button. When the “**Are you sure?**” message is displayed, press the **YES** button to actually make the specified changes, or **NO** to cancel.

When this is completed, the **WRITE** button will change to **UNDO**, allowing you to undo the Write operation and restore the data of the edited track to what it was before you made any edits.

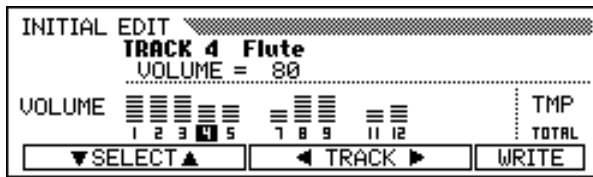

### 5 Exit the Initial Edit function.

To do this, press the **[REC]** button.

- ➔ The **[REC]** lamp goes out and the Initial Edit operation is completed.

You can also exit the Initial Edit function by pressing the **[EXIT]** button.

If you do this after making any edits that you have not yet written to disk, a “Write edited data?” message will be displayed. Press **YES** to write the edited data and exit from the Initial Edit mode, **NO** to exit without writing the data, or **CANCEL** to return to the Initial Edit mode and continue editing.

#### NOTE

- All edited data for any number of tracks within a single song can be written in a one-time Write operation, by pressing the **WRITE** button.
- You can check whether the results of the Initial Edit operation are what you expected by starting and stopping playback with the **[PLAY/STOP]** button. (You should try this before you do something that would make it impossible to select the **UNDO** function.)
- The Undo function cannot be used once you've changed the setting again, changed a different setting, or exited from the Initial Edit mode.
- The Undo feature cannot be used for data recorded to internal memory (see page 133).

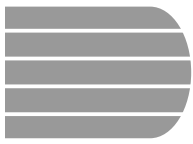

# Recording Without a Disk .....

The Clavinova has about 26 KB of internal memory that you can use to record a limited amount of song data — approximately 2,500 notes, if no other data is recorded — without using a floppy disk.

## About the CVP MEMORY Song

If you enter the Song Record mode without inserting a disk, the words **CVP MEMORY** will appear in the SONG display as shown below, and the Quick Recording, Track Recording and Punch-in/out Recording functions will become available.



When you enter the Song Play mode after recording a song in the memory, the **SONG** function displays the letters **CVP** in place of a song number. You can play this song back as you would any other song that was recorded to disk (see page 93).



SONG PLAY [MAIN] display when playing back the CVP MEMORY song.

If you insert a song disk and select a song number when the internal memory contains song data, a “**Delete CVP MEMORY?**” message will be displayed. Press **YES** to delete the song data from the internal memory. The song data will also be erased from the internal memory by turning the power off. If you wish to keep the recorded data, use the Song Copy function (page 142) to copy the recorded data to disk.

### NOTE

- Chord Sequence data (page 121) cannot be recorded to internal memory.
- The Song Name (page 127) and Setup Memory (page 126) functions cannot be used when editing a song recorded to the internal memory.
- You can use the Track Edit (page 128) and Initial Edit (page 130) functions to edit a song in the internal memory.

### NOTE

Song data recorded to internal memory will be deleted when you load a style file. In this case, no message is displayed.

# CHAPTER 8: The Utility Functions

The Function mode provides various advanced functions that, for example, let you make various MIDI settings, or give you greater, more convenient control over disk-related operations. These sophisticated functions let you customize the Clavinova to your own musical needs and preferences.

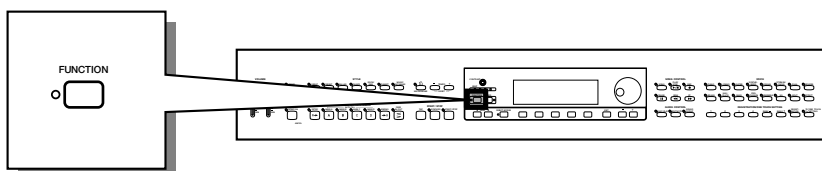

The following functions are available:

Group	Display	Function	Page
KEYBOARD	1	Tune	136
		Transpose	136
	2	Key Touch & Fixed Velocity	137
		Voice Setting	137
PEDAL	3	Left Pedal & Glide Range	138
DISK	4	Registration & Setup Files	139
	5	Song Copy & Disk Copy	142
	6	Song Delete	144
	7	Song Data Transform	145
	8	Disk Format	146
MIDI	9	Send Channel (Keyboard)	147
		Local Control	147
		Synchronization	148
	10	MIDI Filter	148
	11	Receive Filter	149
	12	MIDI Transpose	150
		Send Channel (Accompaniment/Harmony)	150
Song Transmission		151	
Remote Keyboard		151	
BACKUP	13	Backup	152
	14	Recall	153
UTILITY	15	Micro Tuning	154
	16	Scale Tuning	155

Various confirmation, alert, and error messages may appear in the display during operation. Refer to the “Messages” section (page 165) for information on the messages.

## ■ Using the Utility Functions .....

As the table on the preceding page shows, the utility functions are divided among 16 display pages. Use the following procedure to display the page containing a desired function.

### 1 Press the [FUNCTION] button.

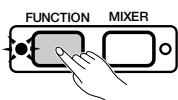

- The lamp lights and the most recently used page of the Function mode display appears.

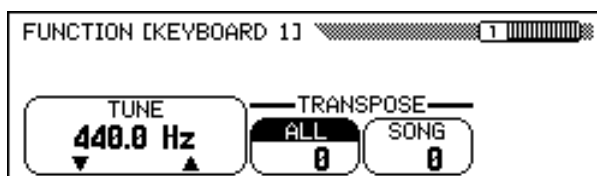

### 2 Display the desired page.

Use the PAGE [◀] and [▶] buttons to display the page that contains the function you want to set.

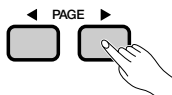

### 3 Perform the desired operation.

Refer to Chapter 2 “Basic Operation” for instructions regarding the selection and use of the various types of functions.

### 4 Press the [FUNCTION] button when finished.

- The [FUNCTION] lamp goes out.

#### NOTE

You can also exit the Function mode by pressing the [EXIT] button.

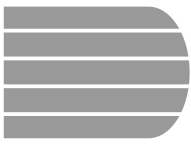

# Keyboard.....

## FUNCTION [KEYBOARD 1] Display — page 1

### ■ Tune .....

The Tune function lets you make fine adjustments to the pitch, allowing you to accurately match the tuning with that of other instruments. The frequency (in Hz) of A3 is displayed by the **TUNE** function. The tuning can be adjusted up or down a maximum of approximately 26 Hz (slightly over 100 cents) in 0.2-Hz steps.

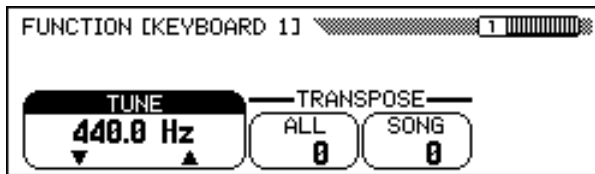

### ■ Transpose .....

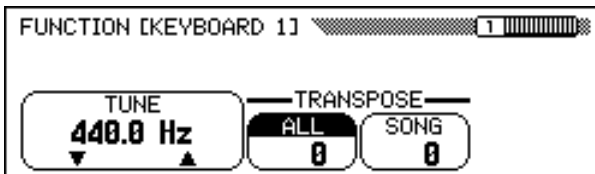

The Transpose functions make it possible to shift the pitch of the keyboard or song data in semitone units, allowing you to match the pitch of the Clavinova to the range of other instruments or singers.

The Clavinova has two transpose functions: **ALL** and **SONG**. The former transposes all notes played by the Clavinova, whereas the latter transposes song data only. When you change the setting of the **ALL** function, the **SONG** setting is also adjusted by the same amount.

#### NOTE

##### TUNE

- Range: 414.8 Hz — 466.6 Hz  
(-102.1 — +101.62 cents)
- Basic setting: 440 Hz

#### NOTE

##### Hz and Cents

- Pitch is measured in units of Hertz (abbreviated Hz), which represents the number of times the sound wave vibrates in a second.
- A cent is a unit of pitch equal to 1/100 of a semitone (100 cents = 1 semitone).

#### NOTE

- Tune has no effect on the Drum Kit voices.
- The XG Master Tune setting is effective when playing back songs containing XG Master Tune data.

#### NOTE

##### TRANSPOSE functions

- Range: -24 — +24 semitones  
(-2 — +2 octaves)
- Basic setting: 0

#### NOTE

- The Transpose function does not affect the Drum Kit voices.
- When playing back songs containing XG Transpose data, the XG Transpose data is effective only for the data playback sound. The value set on the panel affects the keyboard sound.
- The values set here affect playback data transmitted via MIDI.
- When a Transpose function is set to a high value, notes played in the corresponding range at the upper end of the keyboard (e.g., C5 through C7 for a value of +24) may not sound as expected. The same is true of notes at the lower end of the keyboard when a low Transpose value is set.



# FUNCTION [KEYBOARD 2] Display — page 2

## ■ Key Touch & Fixed Velocity .....

The Key Touch function determines how velocity affects the volume of the voices played by the Clavinova's keyboard. Select from four Key Touch settings to tailor the keyboard response to the selected voice, type of song, or your personal playing style. Press the **KEY TOUCH** button to change the setting. The data dial and [-] and [+] buttons cannot be used.



### Key Touch Settings

<b>NORMAL</b>	This is the standard keyboard response and is used as the basic setting.
<b>SOFT</b>	This setting lets you produce a relatively loud sound even when playing the keys softly.
<b>FIXED</b>	This setting produces a uniform degree of loudness, no matter how forcefully or softly you play the keys. Use the FIXED VELOCITY function to set the loudness of notes produced by the keyboard.
<b>HARD</b>	This setting requires you to play the keys quite strongly to produce maximum loudness

## ■ Voice Setting .....

This function determines whether the basic reverb, chorus, effect, and other settings for each voice are automatically selected when a voice is selected. Press the **VOICE SETTING** button to change the setting. When it is set to **AUTO**, the basic settings for each voice are automatically selected when the voice is selected; when it is set to **MANUAL**, the settings do not change when voices are selected.

**NOTE**

**Velocity**

- The amount of force applied to a key is frequently referred to in this manual as velocity. This is because the Clavinova determines the amount of force that was applied to a key by measuring the speed with which the key was depressed.
- This function does not affect the actual weight of the keys.

**NOTE**

**KEY TOUCH**

- Settings: See table at left.
- Basic setting: **NORMAL**

**NOTE**

**FIXED VELOCITY**

- Range: 1 — 127
- Basic setting: 76

**NOTE**

**VOICE SETTING**

- Settings: **AUTO, MANUAL**
- Basic Setting: **AUTO**

**NOTE**

The following settings are automatically selected when **VOICE SETTING** is set to **AUTO**:

<b>Function</b>	<b>Page</b>
Reverb ON/OFF	41
Reverb depth settings	42
Chorus depth settings	45
Effect ON/OFF	46
EFFECT TYPE	47
Effect DEPTH	48
Effect VARIATION	47
HARMONY TYPE	70
Harmony SPEED	71
Harmony VOLUME	71
OCTAVE settings	32, 34, 38

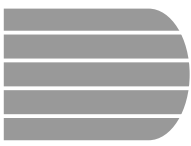

## FUNCTION [PEDAL] Display — page 3

### ■ Left Pedal & Glide Range.....

This function conveniently lets you set the left pedal to control one of various functions.

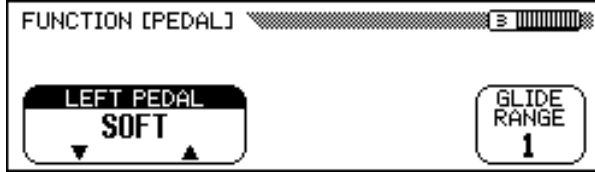

#### LEFT PEDAL Settings

Setting	Description
<b>SOFT</b>	The left pedal functions as the soft pedal (basic setting). (See page 40.)
<b>START/STOP</b>	The left pedal functions as the [START/STOP] button. (See page 52.)
<b>HARMONY</b>	When the Harmony function is set to on, Harmony is applied only while the left pedal is held down. (See page 69.)
<b>REGISTRATION</b>	The panel settings registered to the next Registration number are recalled each time the left pedal is pressed. (See page 91.)
<b>REG.FREEZE</b>	The left pedal switches the Registration Freeze function on and off; that is, it performs the same function as the FREEZE button in the REGISTRATION [FREEZE] display (page 91).
<b>ENDING/RIT</b>	The left pedal functions as the [ENDING] button. You can have the song end ritardando (slow down gradually) by pressing the left pedal twice in succession. (See page 56.)
<b>BREAK</b>	Pressing the left pedal during style playback produces a break in the accompaniment and rhythm for as long as the pedal is held. When the pedal is released, normal playback resumes from the next measure. If you press the left pedal a second time within one measure, normal playback resumes immediately.
<b>BREAK FIL</b>	Pressing the left pedal during style playback causes the Clavinova to play a special "break fill-in" pattern. This pattern is different from the fill-in patterns produced by the Auto Fill function. (See page 51.)
<b>BASS HOLD</b>	While the left pedal is pressed, the bass note played by the Auto Accompaniment will be held even if the chord is changed. This function does not work when FULL KEYBOARD is selected as the accompaniment mode (page 61).
<b>FADE IN/OUT</b>	The left pedal performs the function same as the [FADE IN/OUT] button. (See pages 55 and 56.)
<b>EFFECT VARI</b>	This function switches the effect variation on or off; that is, it performs the same effect as the VARIATION button in the EFFECT display (page 47).
<b>GLIDE UP S</b> <b>GLIDE UP M</b> <b>GLIDE UP F</b>	Pressing the left pedal causes the pitch to rise an amount specified by the GLIDE RANGE function. When the pedal is released, the pitch glides smoothly back to normal at one of three speeds (slow, medium or fast, depending on the selected setting).
<b>GLIDE DOWN S</b> <b>GLIDE DOWN M</b> <b>GLIDE DOWN F</b>	Pressing the left pedal causes the pitch to drop an amount specified by the GLIDE RANGE function. When the pedal is released, the pitch glides smoothly back to normal at one of three speeds (slow, medium or fast, depending on the selected setting).

#### NOTE

##### LEFT PEDAL

- Settings: See table at left.
- Basic setting: SOFT

#### NOTE

If the left pedal is set to REGISTRATION, the setting of the left pedal function in Registration memory is not recalled.

#### NOTE

##### GLIDE RANGE

- Settings: 1 — 12 (semitones)
- Basic setting: 1



## FUNCTION [DISK 1] Display — page 4

### ■ Registration & Setup Files .....

You can use the functions on this page to load, save, delete, and re-name data files containing registration data (page 89) or panel setup data.

Before executing one of these functions, make sure that the disk you want to use for this operation is inserted in the disk drive.



#### 1 Select the file type.

Press either of the two leftmost LCD buttons to select the file type to be loaded, saved, deleted or named.

<b>REGISTRATION</b>	A Registration file may contain the data for just one registration, or a full set of twenty. Refer to page 13 in the Reference Booklet for a list of settings registered by the Registration function.
<b>ALL SETUP</b>	An All Setup file contains all panel setting data in the list on page 13 in the Reference Booklet.

➤ If you select **REGISTRATION** as the file type, you can also use the **REGIST** function to specify whether the operation will affect one memory location or a full set of twenty.

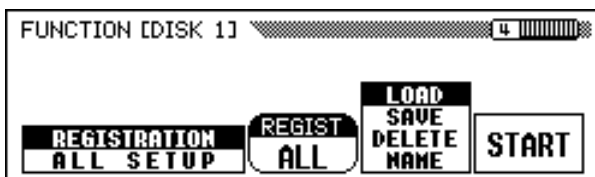

When saving registration data, the **REGIST** setting specifies which memory location(s) will be saved to disk. When loading data, the **REGIST** setting specifies how the registration data will be loaded, as shown below:

	<b>REGIST setting:</b>	
<b>File contains:</b>	<b>ALL</b>	<b>A1 — E4</b>
<b>All registrations</b>	All registrations are loaded.	Only registration saved from specified location is reloaded (to original location).
<b>One registration</b>	Selected registration file is loaded into original location.	Selected registration file is loaded into specified location.

#### NOTE

You can delete or rename any registration file on the disk, regardless of the **REGIST** setting.

**2 Select the file operation.**

Use the second LCD button from the right to select the desired file operation: **LOAD**, **SAVE**, **DELETE** or **NAME**.

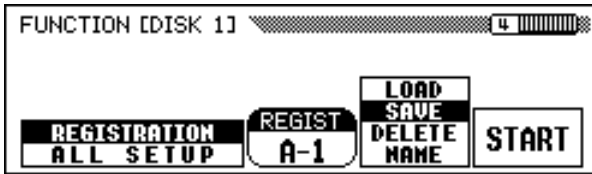

**3 Press the START button.**

→ The file operation begins.

The subsequent steps for each file operation depend on the operation you've selected. Refer to the corresponding instructions for each operation below.

**NOTE**

File operations cannot be performed while the [SONG] lamp is lit. Exit the Song mode before attempting to perform a file function.

**LOAD**

When you select **LOAD**, the Load function display will appear. The original internal data will be replaced when you execute the Load operation. Be sure to save all important data to disk (see below) before using the Load operation.

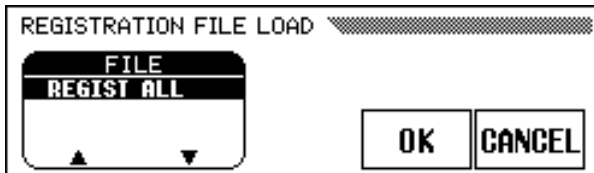

First, select the desired file to be loaded. Press either of the two leftmost LCD buttons to select the file, then press the **OK** button.

→ An **"Are you sure?"** message is displayed. Press the **YES** button to load the selected file, or the **NO** button to abort the Load operation.

**SAVE**

When you select **SAVE**, the name entry function display for the file to be saved will appear.



Press the ► button to move the underline cursor, and select the character position of the file name. (File names can contain up to twelve characters.)

➤ Use the data dial or [-] and [+] buttons to highlight the characters to be input.

Press the **CH.SET** button to input the selected characters at the current underline position of the file name. Continue moving the cursor to other characters or marks and entering them in this way.

To delete the character at the previous position, press the **BACK** button. The character before the underline cursor is deleted and the cursor moves back to the deleted position.

To abort the name entry operation and return to the FUNCTION [DISK 1] display, press the **CANCEL** button.

When the file name has been completely entered, press the **SAVE** button to execute the Save operation.

If you enter a name that already exists on the disk, a “**Same name! Overwrite?**” message will appear. Press the **OK** button to overwrite the original file with the new file, or **CANCEL** to cancel the Save operation.

## ■ DELETE

When you select **DELETE**, the Delete function display will appear.

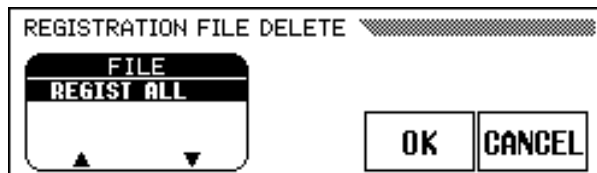

First, select the desired file to be deleted. Press either of the two leftmost LCD buttons to select the file, then press the **OK** button.

- An “**Are you sure?**” message is displayed. Press the **YES** button to delete the selected file, or the **NO** button to abort the Delete operation.

## ■ NAME

When you select **NAME**, the Name function display will appear.

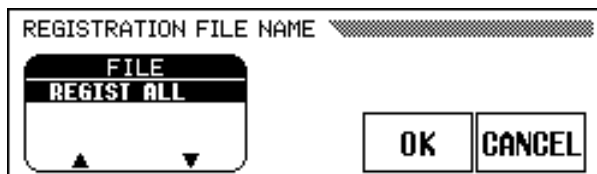

First, select the desired file to be named. Press either of the two leftmost LCD buttons to select the file, then press the **OK** button.

- The name entry display will appear. Enter a new file name in the same way as described above for the Save function.
- Pressing the **OK** button changes the current name to the newly entered name. Press the **CANCEL** button to abort. If you enter a name that already exists on the disk, a “**Same name! Overwrite?**” message will appear. In this case, press the **OK** button to overwrite the original file with the renamed file, or **CANCEL** to abort the Name operation.

## FUNCTION [DISK 2] Display — page 5

### ■ Song Copy & Disk Copy

The functions on this page allow you to copy song data recorded by the Clavinova to a different song number on the same disk, or to a different disk. You can also use the Disk Copy function to copy an entire disk.

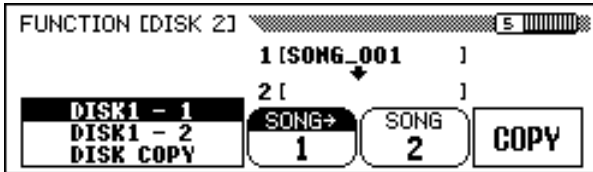

#### 1 Select a copy function.

First insert the disk containing the source song, or the disk to be copied.

➤ Press either of the leftmost two LCD buttons to select the copy type. Three copy types are available.

<b>DISK1 - 1</b>	This function allows you to copy a song to a different song number on the same disk.
<b>DISK1 - 2</b>	This function allows you to copy a song to a different disk.
<b>DISK COPY</b>	This function copies all the data from one disk to another disk. (All data on the destination disk is erased by this process.)

#### 2 Select the source song.

If you selected **DISK1 - 1** or **DISK1 - 2** in step 1, press the **SONG →** button, then use the data dial or [-] and [+] buttons to select a song number from 1 to 99.

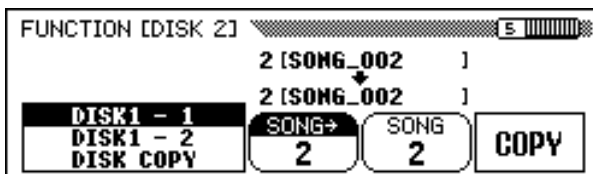

➔ The number and name of the selected song are displayed above the third and fourth LCD buttons.

#### NOTE

The Song Copy and Disk Copy functions cannot be executed while the [RECORD] lamp is lit. Exit the Song Record mode before attempting to copy a song or disk.

#### NOTE

- You will not be able to select **DISK1 - 1** as the copy function if the disk you inserted is write protected (page 9).
- If the Clavinova's memory contains song data recorded without a disk (page 133), **CVP - DISK** will automatically be selected as the copy function. If you want to keep the **CVP MEMORY** song data, you can use this function to copy it to a disk. (Insert the disk, specify a destination song number as described in step 3, then execute the copy function as usual.) You can then use the **Song Delete** function (page 144) to delete the **CVP MEMORY** song. Once the song has been deleted, you will be able to use the other copy functions.

### 3 Select the destination song number.

If you selected **DISK1 - 1** as in step 1, press the **SONG** button, then use the data dial or [-] and [+] buttons to select a destination song number between **1** and **60**. (Song numbers above **60** cannot be selected.)

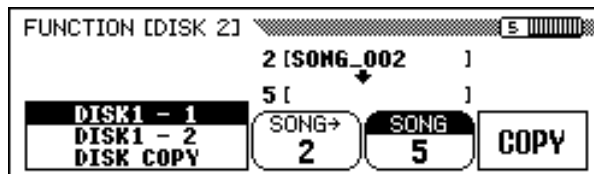

- If the destination song number already contains data, the name of the song file will appear in the middle section of the display. In this case, the original data of the destination song number will be replaced by the source song data when you execute the copy operation.

### 4 Execute the copy operation.

Press the **COPY** button.

- The copy operation begins. If you are copying to the same disk, an “**Are you sure?**” message is displayed. Press the **YES** button to continue or the **NO** button to cancel.

If you are copying the data to a different disk (or copying an entire disk), a “**Number of disk exchanges (\*\*)**” message appears to indicate the number of times the disk will have to be changed. Press the **OK** button to continue, or the **CANCEL** button to abort the operation.

When copying data between disks, follow the instructions in the display, inserting the source and destination disks as required.

If you are using the **DISK1 - 2** function to copy a song to another disk, the “**Select destination song number**” message will appear the first time you insert the destination disk. Use the data dial or [-] and [+] buttons to select a destination song number between **1** and **60**. (Song numbers above **60** cannot be selected.)

- If the destination song number already contains data, the song name will appear in the display. In this case, the original data of the destination song number will be replaced by the source song data. Press the **OK** button to continue, or **CANCEL** to abort.

#### NOTE

The copy operation cannot be executed if the same song number is selected as both the source song and the destination song for the **DISK1 - 1** function. In this case, a “Select a different number!” message will appear.

#### NOTE

##### Copying Commercial Software

- Copying of commercially available software is strictly prohibited, except for your personal use.
- Some commercially available software is purposely copy-protected, and cannot be copied using these functions.

#### NOTE

Data files (other than those made with the CVP-109/107/105/103) that have been copied once cannot be copied a second time to another disk. Also, additional data can be recorded only to the right-hand/left-hand parts of the copied DOC files.

## FUNCTION [DISK 3] Display — page 6

### ■ Song Delete .....

You can delete unneeded song data from the disk in this display. Be careful not to delete any important data on the disk; once the delete operation is performed, it cannot be undone.

#### 1 Insert the disk.

Insert the disk containing the song data to be deleted into the disk drive.

#### 2 Select the song to be deleted.

Use the **SONG** ▼ and ▲ buttons, the data dial, or the [-] and [+] buttons to select the song to be deleted. The song data in the Clavinova's memory can be also deleted with this operation. To do this, select **CUP MEMORY** instead of a song number (**CUP MEMORY** appears only when the memory contains song data).

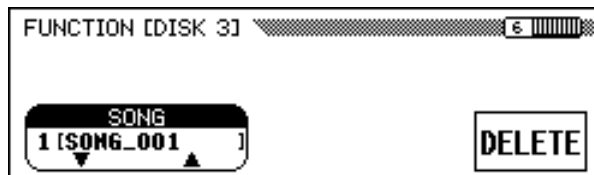

#### 3 Execute the delete operation.

Press the **DELETE** button.

- ➔ An **"Are you sure?"** message will be displayed. Press the **YES** button to delete the selected song, or press the **NO** button to cancel the operation.

#### NOTE

*The Song Delete function cannot be executed while the [RECORD] lamp is lit. Exit the Song Record mode before attempting to delete a song.*



# FUNCTION [DISK 4] Display — page 7

## ■ Song Data Transform .....

This function allows you to convert song data recorded on the CVP-103 for playback on other Clavinova models or a Disklavier.

### 1 Insert the disk.

Insert a 2DD disk containing the data to be converted in the disk drive.

### 2 Select a data format.

Use either of the two leftmost LCD buttons to select the target format of the file (the type of instrument that will use the converted data). The following three types are available:

<b>CVP PERFORMANCE</b>	This function converts data for playback on the CVP-50/70/55/65/75/83S/85A/87A/89, the DOM-30, and the DOU-10.
<b>PIANO FORMAT 1</b>	This function converts data for playback on all Disklavier models except the MX100A and the MX100B.
<b>PIANO FORMAT 2</b>	This type converts the data for playback on the Disklavier MX100A or MX100B.

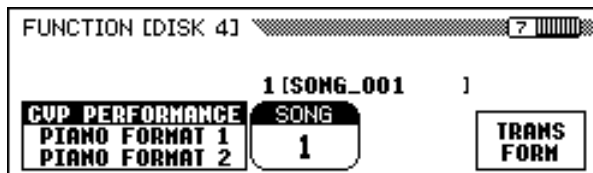

### 3 Select the song to be converted.

Use the data dial or [-] and [+] buttons to select the song number of the song to be converted.

- The number and name of the selected song are displayed above the **SONG** function.

### 4 Press the TRANSFORM button.

- An “**Are you sure?**” message is displayed. Press the **YES** button to convert the selected song, or **NO** to cancel the operation. When the conversion process is finished, a “**Completed! SONG No.\*\***” message indicates the song number to which the data was saved.

If **CVP PERFORMANCE** was selected in Step 2, the characters “**C**” are appended to the beginning of the original name. If one of the other formats was selected, the characters “**P**” are appended.

#### NOTE

The Song Data Transform function cannot be used while the [SONG] lamp is lit. Exit the Song mode before attempting to transform song data.

#### NOTE

##### 2DD Disks Only!

Only data saved on 2DD disks can be converted. To transform song data that has been saved on a 2HD disk or recorded in the Clavinova’s memory, use the Song Copy function (page 142) to copy the song to a 2DD disk before you attempt to convert it.

#### NOTE

##### Data Format Compatibility

CVP-series Clavinovas other than the models listed in the table at left can play back song data recorded on the CVP-103 without conversion.

If you are planning to use your song data on other instruments and want to ensure that they will closely reproduce the sound you achieved on the CVP-103, however, we recommend using XG voices (see page 30) for all tracks other than those that play piano voices.

#### NOTE

- The converted data is saved to a song number between 1 and 60. (Song numbers above 60 are not used.)
- The original data remains intact at the original song number even after the conversion has been executed.
- Recording or editing cannot be performed on the converted songs.

## FUNCTION [DISK 5] Display — page 8

### ■ Disk Format .....

Floppy disks must be correctly formatted before the Clavinova can use them for data storage. If you insert a new, unformatted disk (or a disk that has already been initialized in a different format) in the disk drive, the Clavinova will automatically ask you whether it should format the disk. (See page 111 for details.)

The Clavinova also has a Disk Format function that can be used to reformat disks that have already been formatted for use by the Clavinova. The reformatting operation deletes any data that may have been saved on the disk.

#### 1 Insert the disk to be formatted.

Make sure that the disk's write protect tab is set to the "write" position, and insert the disk into the disk drive face up with the shutter forward until it clicks into place.

#### 2 Execute the format operation.

Press the **START** button.

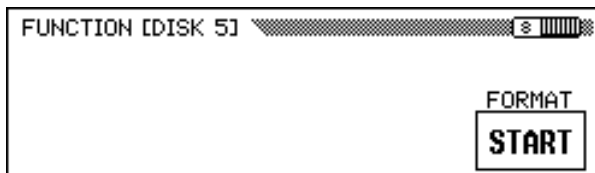

➔ An "Are you sure?" message is displayed. Press **YES** to execute the format, or **NO** to cancel.

A bar graph indicates the progress of the formatting process. Once the disk has been formatted, the Clavinova can use it to store songs and other data.

#### NOTE

The Disk Format function cannot be used while the [SONG] lamp is lit. Exit the Song mode before attempting to format a disk.

#### CAUTION

Formatting a disk erases all the data on the disk. Before you format a disk, make sure it doesn't contain any data that you want to keep.

#### NOTE

##### Format Types

2DD disks are formatted to hold 720 KB of data; 2HD disks are formatted to hold 1.44 MB of data.



## FUNCTION [MIDI 1] Display — page 9

### ■ Send Channel (Keyboard) .....

In any MIDI control setup, the MIDI channels (1 through 16) of the transmitting and receiving equipment must be matched for proper data transfer. The **SEND CH** function lets you set the MIDI transmit channels for the keyboard parts.

Part	Explanation	Basic Setting
LEFT	Left voice in Split mode (see page 36)	3
RIGHT1	Main voice	1
RIGHT2	Second voice in Dual mode (see page 33)	2

You can set each keyboard part to transmit on a separate channel. If you set a part to **OFF**, the MIDI data for that part will not be transmitted.

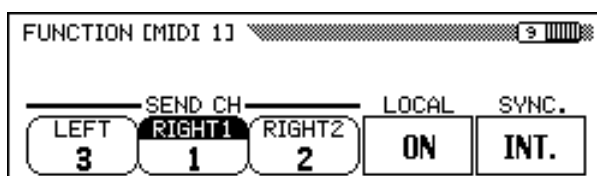

#### NOTE

##### SEND CH

- Settings: OFF, 1 — 16
- Basic setting: See table at left.

### ● MIDI Reception

The Clavinova always receives MIDI data in the “Multi Timbre” mode. This is a mode in which the Clavinova voices can be independently controlled on different MIDI channel numbers (1 through 16) by an external MIDI device. This means that you can produce the sound of a full band or ensemble on the Clavinova by using a computer or MIDI sequencer.

### ■ Local Control .....

The term “local control” refers to the control of the internal tone generator by the keyboard. You will normally play the Clavinova with the Local Control function set to **ON**.

Turning off the local control separates the keyboard from the tone generator, so that the Clavinova will not output any sound when you play the keyboard. Since keyboard performance data is still output via the MIDI jacks, however, you can use this setting when you want to play an external MIDI tone generator from the Clavinova’s keyboard without sounding the internal voices.

To turn the local control on or off, press the **LOCAL** button. The data dial and [-] and [+] buttons cannot be used.

#### NOTE

##### LOCAL

- Settings: ON, OFF
- Basic setting: ON

■ **Synchronization** .....

The playback tempo of a song or style is normally controlled by the Clavinova's internal clock. When you want the Clavinova's playback tempo to be controlled by an external sequencer or rhythm machine, you should set the synchronization function to use an external clock. You might use this function, for example, to play the Auto Accompaniment of the Clavinova in perfect synchronization with an external sequencer.

To switch the synchronization from an internal clock to an external clock (or vice versa), press the **SYNC.** button. The data dial and the [-] and [+] buttons cannot be used.



**SYNC.**

- Settings: *INT.* (internal clock), *EXT.* (external clock)
- Basic setting: *INT.*

**FUNCTION [MIDI 2] Display — page 10**

■ **MIDI Filter** .....

The FUNCTION [MIDI 2] display contains MIDI filter settings that can be used to enable or prevent the transmission and reception of certain types of MIDI data.

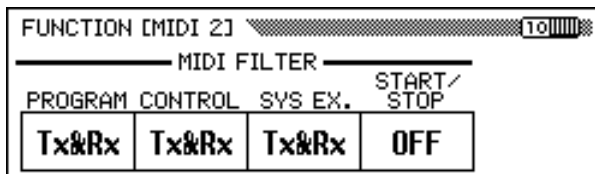

● **Program Change Messages**

Normally the Clavinova will respond to MIDI program change numbers received from an external keyboard or another MIDI device. For example, the Clavinova can change voices in response to MIDI program change messages received from a connected MIDI sequencer. (These messages do not affect the keyboard-played voices.) The voices of connected external MIDI devices can also be changed by program change messages transmitted from the Clavinova. (Program change messages are transmitted when changing voices on the panel of the Clavinova.)

Depending on your particular MIDI setup, you may find that this feature is convenient in some cases and not in others. Set the **PROGRAM** function to **OFF** to disable the transmission and reception of program change messages.



**PROGRAM**

- Settings: *Tx&Rx* (transmitted/received), *OFF*
- Basic setting: *Tx&Rx*



Bank MSB and LSB messages can be transmitted and received even when PROGRAM is set to OFF.

● **Control Change Messages**

Control change messages are used for various non-keyboard performance controls, such as the damper pedal, or for expressive control of the sound of a connected MIDI device, such as effects and volume. For example, the Clavinova can respond to control change messages transmitted from an external MIDI sequencer. (These messages do not affect the keyboard-played voices.) Similarly, an external MIDI device can be controlled by sending control change messages from the Clavinova to that device. (Control change messages are transmitted when operating the damper pedal, etc., on the Clavinova.)

Set **CONTROL** to **OFF** to disable the transmission and reception of control change messages.

The control change data recognized by the Clavinova is listed in detail on page 17 in the Reference Booklet.

● **System Exclusive Messages**

System exclusive messages are used for more advanced or detailed MIDI control, or for controls related to specific manufacturer's devices.

Set **SYS EX.** to **OFF** to disable the transmission and reception of system exclusive messages.

The system exclusive data recognized by the Clavinova is listed in detail on page 19 in the Reference Booklet.

● **Start/Stop Commands**

A device that transmits the Start/Stop command can start and stop the rhythm or sequence data performance of a receiving device via MIDI. For example, you can transmit the Start/Stop command from an external MIDI sequencer to start and stop the Auto Accompaniment or song playback on the Clavinova. Also, an external MIDI sequencer or rhythm machine can be started and stopped by starting and stopping the Auto Accompaniment on the Clavinova.

Set **START/STOP** to **ON** to enable the transmission and reception of Start/Stop commands.



**CONTROL**

- Settings: Tx&Rx (transmitted/received), OFF
- Basic setting: Tx&Rx



**SYS EX.**

- Settings: Tx&Rx (transmitted/received), OFF
- Basic setting: Tx&Rx



**START/STOP**

- Settings: Tx&Rx (transmitted/received), OFF
- Basic setting: OFF

**FUNCTION [MIDI 3] Display — page 11**

■ **Receive Filter** .....

The Receive Filter function lets you prevent the Clavinova from receiving channel-specific MIDI messages — such as note data and control changes — on certain MIDI channels.

This function is useful, for example, when you want to control some of the Clavinova's voices exclusively from an external sequencer, and others using only the Clavinova's keyboard or its built-in Auto Accompaniment and Song mode functions. (You can also have the Clavinova ignore channels carrying messages that are intended for another instrument connected to the Clavinova's MIDI [THRU] terminal.)

By default, the Clavinova will receive messages on all 16 channels. Use the following procedure to enable or disable the reception of a channel:



**RECEIVE FILTER**

- Settings: ON, OFF (x 16)
- Basic setting: ON (x 16)

**1 Select the channel.**

Use the **CHANNEL** ◀ and ▶ LCD buttons to select the number of the channel you want to enable or disable.

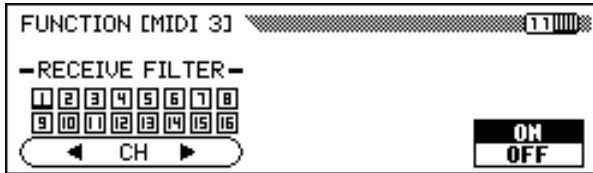

→ An underline cursor is displayed below the selected channel number.

**2 Press the rightmost LCD button.**

→ When the selected channel is enabled, **ON** is highlighted and the channel number is enclosed in a solid box. When it is disabled, **OFF** is highlighted, and the channel number is displayed without a surrounding box.

**FUNCTION [MIDI 4] Display — page 12**

**■ MIDI Transpose .....**

The MIDI Transpose function determines whether the Transpose setting in the FUNCTION [KEYBOARD 1] display (page 136) will affect the MIDI data received by the Clavinova.

The Clavinova will normally transpose the data it receives. Press the **MIDI TRANSPOSE** button to switch this function on or off.

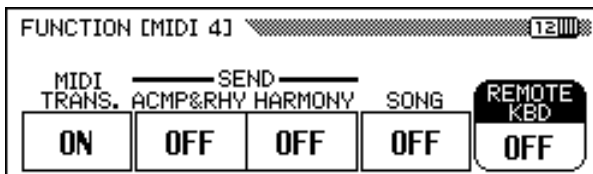

**■ Send Channel (Accompaniment/Harmony) .....**

When the **ACMP&RHY** function is set to **9–16ch**, the performance data for the rhythm and accompaniment parts is transmitted via the MIDI [OUT] terminal over MIDI channels 9 through 16.

If the **HARMONY** function is set to **6–8ch**, the notes added by the harmony types listed below are transmitted via the MIDI [OUT] terminal over MIDI channels 6 through 8.

**NOTE**

**MIDI TRANSPOSE**

- Settings: **ON** (enabled), **OFF** (disabled)
- Basic setting: **ON**

**NOTE**

**SEND CH (ACMP&RHY)**

- Settings: **OFF** (not transmitted), **9–16ch** (transmitted)
- Basic setting: **OFF**

**SEND CH (HARMONY)**

- Settings: **OFF** (not transmitted), **6–8ch** (transmitted)
- Basic setting: **OFF**

**Harmony types transmitted on channels 6 through 8:**

• Echo	• Tremolo	• Trill	• Strumming
• Add Jazz Gtr	• Add Brass	• Add Strings	• In The Forest

\* See page 69 for details on the Harmony function.

Notes added by other harmony types are always transmitted on the RIGHT1 channel (page 147), regardless of this setting.

The rhythm, accompaniment, and harmony parts can be recorded by a computer or external sequencer when these functions are turned on.

**■ Song Transmission**

When the **SONG** function is set to **ON**, the Clavinova will transmit song data via the MIDI [OUT] terminal. Select this setting when you want an external tone generator to sound in response to song data played back by the Clavinova.

The transmission of song data is turned off by default.

**■ Remote Keyboard**

MIDI data received over the channel set with the **REMOTE KBD** function will affect your keyboard performance. The received data also can be recorded. Select **OFF** to prevent external MIDI data from affecting your keyboard performance. The following data types can be received:

- Key ON/OFF
- Control Change (performance data; only those listed below)
 

#1	Modulation	#0	BANK Select MSB*
#7	Volume	#32	BANK Select LSB*
#11	Expression	#6	Data Entry MSB (for RPN Pitch Bend Range)
#64	Sustain Pedal	#96	Data Increment (for RPN Pitch Bend Range)
#66	Sostenuto Pedal	#97	Data Decrement (for RPN Pitch Bend Range)
#67	Soft Pedal	#100	RPN LSB (Pitch Bend Range only)
#123	All notes off	#101	RPN MSB (Pitch Bend Range only)
- Program Change (voice change data)\*
- Pitch Bend

Note: Items marked with an asterisk are used to change the main voice.

**NOTE**

- When transmitting rhythm, accompaniment, or harmony part data via MIDI, do not select the MIDI channels used by these parts as the send channels (page 147) used to transmit the data for your keyboard performance. Doing so may result in your keyboard performance data being mixed with the Auto Accompaniment or Harmony data.
- If **ACMP&RHY** or **HARMONY** is turned on, the data for the corresponding part(s) will be transmitted via MIDI, even if the **RIGHT1** send channel (page 147) has been turned off.

**NOTE**

**SONG**

- Settings: **OFF** (not transmitted), **ON** (transmitted)
- Basic setting: **OFF**

**NOTE**

**REMOTE KBD**

- Settings: **OFF** (not received), **1 — 16** (receive channel)
- Basic setting: **OFF**

**NOTE**

MIDI data received by the remote keyboard function cannot be output via the MIDI [OUT] terminal.

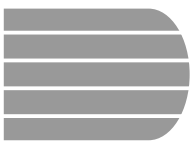

## FUNCTION [BACKUP 1] Display — page 13

### ■ Backup .....

This function allows you to set the backup of various parameter groups on or off. When set to on, the corresponding settings will not be reset to the basic settings (default settings) when power is turned off.

Press the ▼ or ▲ button or use the data dial or [-] and [+] buttons to select the desired group, then use the rightmost LCD button to set the selected group to backup on/off. The (“\*”) mark at the beginning of the group name indicates that the backup setting of the group is turned on. The settings of groups whose backup settings are set to off will return to the basic settings (default settings) when the power is turned off.

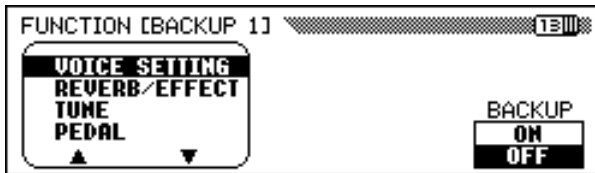

Backup is used for the following groups on the Clavinova.

Group	Description
<b>VOICE SETTING</b>	Voice-related settings
<b>REVERB/EFFECT</b>	Reverb, chorus, and effect settings
<b>TUNE</b>	Master tuning, micro tuning, scale tuning
<b>PEDAL</b>	Pedal function settings
<b>ACMP SETTING</b>	Auto Accompaniment-related settings
<b>SONG SETTING</b>	Settings related to the Song mode
<b>REGISTRATION</b>	Registration data, Freeze function settings
<b>MIDI SETTING</b>	MIDI function settings

Refer to page 13 in the Reference Booklet for a list of the specific parameters in each group.

Parameters that are backed up will be retained in memory for about a week if the Clavinova is not turned on during this time. All parameters will be reset to their default values if the power remains off for longer than about a week. To ensure that your backed-up settings are maintained, turn the power on for a few minutes at least once a week.

#### NOTE

##### Backup functions

- Settings: ON, OFF
- Basic settings: ON (REGISTRATION)  
OFF (all other groups)

#### NOTE

##### Permanent Settings

The following settings are always backed up:

- Help language
- Song volume
- Backup ON/OFF



## FUNCTION [BACKUP 2] Display — page 14

### ■ Recall .....

This function can be used to recall the initial factory settings (basic settings) for a group of parameters, or for all parameters at once.

Press the ▼ or ▲ buttons or use the data dial or [-] and [+] buttons to select the group you want to recall, then press the **START** button.

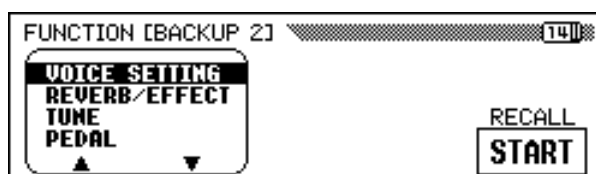

- ➔ An “**Are you sure?**” message will be displayed. Press the **YES** button to recall, or **NO** to cancel.

The following parameter groups of the Clavinova can be recalled.

Group	Description
<b>VOICE SETTING</b>	Voice-related settings
<b>REVERB/EFFECT</b>	Reverb, chorus, and effect settings
<b>TUNE</b>	Master tuning, micro tuning, scale tuning
<b>PEDAL</b>	Pedal function settings
<b>ACMP SETTING</b>	Auto Accompaniment-related settings
<b>SONG SETTING</b>	Settings related to the Song mode
<b>REGISTRATION</b>	Registration data, Freeze function settings
<b>MIDI SETTING</b>	MIDI function settings
<b>ALL</b>	All of the above settings

Refer to page 13 in the Reference Booklet for a list of the specific parameters in each group.

#### NOTE

##### **Permanent Settings**

The factory settings of the following parameters are not recalled:

- Help language
- Song volume
- Backup ON/OFF

However, these and all other settings can be reset to the initial factory values by turning the power on while holding down the rightmost key on the keyboard (C7). When this is done, the “Back up data erased and replaced by factory data” message appears to indicate that all backed up data has been erased and the factory settings have been recalled. After this message is displayed for a few seconds, the main display will appear.

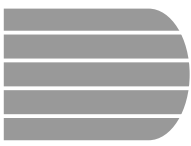

## FUNCTION [MICRO TUNING] Display — page 15

The Micro Tuning Feature makes it possible to individually tune each key of the keyboard. The created tuning can be saved to a disk and loaded whenever necessary. The currently loaded custom tuning can be turned on or off at any time by using the leftmost LCD button in this display.

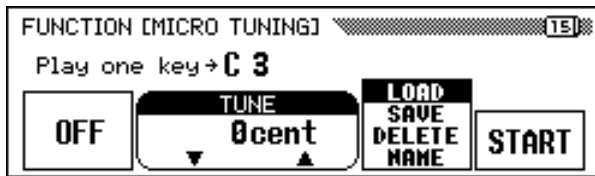

### ■ Micro Tuning Setup.....

#### 1 Select a key.

Press the key to be tuned.

→ The note name and the current tuning value of the pressed key will appear in the display.

#### 2 Set the tuning.

Press the **TUNE ▼** or **▲** buttons or use the data dial or [-] and [+] to tune the pitch of the selected key. If you set the parameter at the leftmost LCD button to **ON**, you can play the key being tuned in order to check the sound during this operation. The normal tuning of ±0 cents for the selected key can be instantly recalled by simultaneously pressing both the **TUNE ▼** and **▲** buttons.

#### 3 Repeat steps 1 and 2.

Repeat steps 1 and 2 until all the required keys have been tuned.

### ■ Micro Tuning Files.....

The custom tuning can be named and saved to disk as a tuning file. Tuning files can be loaded whenever necessary, or deleted when they are no longer needed.

#### 1 Insert a disk in the disk drive.

Make sure that a properly formatted disk has been inserted in the disk drive before executing a file operation. If you want to load, delete, or rename a tuning file, the inserted disk should contain the file in question.



NOTE

#### TUNE

- Range: -100 cent — +100 cent  
-1 — +1 semitone
- Basic Value: 0 cent (all keys)

**2 Select the desired file operation.**

Use the second LCD button from the right to select the desired file operation: **LOAD**, **SAVE**, **DELETE** or **NAME**.

**3 Press the START button.**

After the **START** button is pressed, the display corresponding to the selected file operation appears.

The subsequent steps are the same as those explained on pages 140 through 141. Refer to the pages below, depending on the selected file operation.

<b>LOAD</b>	See page 140.
<b>SAVE</b>	See page 140.
<b>DELETE</b>	See page 141.
<b>NAME</b>	See page 141.

## FUNCTION [SCALE TUNING] Display — page 16

This feature allows you to select from various tuning (temperament) configurations, when selecting **PRESET** in this display. By selecting **USER**, you can create your own user scale, in which the tuning you set for a single octave takes effect for the entire keyboard. The created tuning can be saved to disk for future recall.

**■ Preset Scale .....**

This function lets you select from various pre-programmed tunings or temperaments.

Until equal temperament — the most commonly used tuning at present — was accepted, various tunings have been created over the years for use with the particular music and instruments of the era. This feature lets you play in historically authentic tunings, and get a better feeling for the music of the corresponding eras.

The Clavinova contains the following seven temperaments:

- EQUAL
- PURE(MAJOR)
- PURE(MINOR)
- MEANTONE
- PYTHAGOREAN
- WERCKMEISTER
- KIRNBERGER

**NOTE**

*The Scale Tuning function does not affect the pitch of song data played back by the Clavinova.*

**1 Select PRESET with the leftmost LCD button.**

→ The following display appears:

**2 Select a scale.**

Press the **SCALE** ▼ or ▲ to highlight the parameter, then use the data dial or [-] and [+] buttons to select the temperament type.

When selecting temperaments other than equal (**EQUAL**) temperament, the central key (reference pitch for the temperament) must be set. This allows you to produce the proper temperament in the desired key.



**3 Select the central key.**

Press the **KEY** button to highlight the parameter, then use the data dial or [-] and [+] buttons to select the central key.

**NOTE**

**KEY**

- Settings: C, C#, D, Eb, E, F, F#, G, Ab, A, Bb, B
- Basic setting: C

## ■ User Scale Setup .....

This function allows you to individually tune each key within an octave. The setting made for one key is automatically assigned to the same key in all other octaves.

**1 Select USER with the leftmost LCD button.**

→ The following display appears:

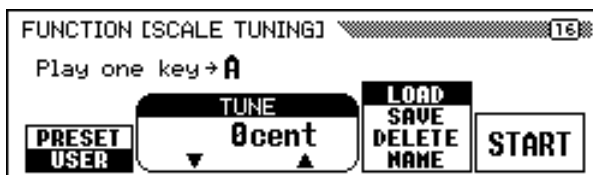

**2 Press the key to be tuned.**

→ The note name and the current tuning value of the pressed key appears.

**3 Set the tuning.**

Set the pitch by pressing the **TUNE** ▼ or ▲ buttons, or by using the data dial or [-] and [+] buttons. You can play the key being tuned to check the sound during this operation. The default tuning of ±0 cents can be instantly recalled for the selected key by simultaneously pressing the **TUNE** ▲ and ▼ buttons.

**NOTE**

**TUNE**

- Range: -64 cent — +63 cent
- Basic Value: 0 (all keys)

**4 Repeat steps 2 and 3 until all the required keys have been tuned.**

## ■ User Scale Files .....

The custom scale can be named and saved to disk as a user scale file. User scale files can be loaded whenever necessary, or deleted when they are no longer needed.

### 1 Insert a disk in the disk drive.

Make sure that a properly formatted disk has been inserted in the disk drive before executing a file operation. If you want to load, delete, or rename a user scale file, the inserted disk should contain the file in question.

### 2 Select the desired file operation.

Use the second LCD button from the right to select the desired file operation: **LOAD**, **SAVE**, **DELETE** or **NAME**.

### 3 Press the **START** button.

After the **START** button is pressed, the display corresponding to the selected file operation appears.

The subsequent steps are the same as those explained on pages 140 through 141. Refer to the pages below, depending on the selected file operation.

<b>LOAD</b>	See page 140.
<b>SAVE</b>	See page 140.
<b>DELETE</b>	See page 141.
<b>NAME</b>	See page 141.

# CHAPTER 9: Connections

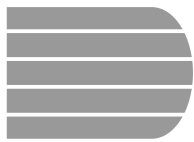

## Audio Connections .....

The Clavinova is equipped with jacks that let you connect a variety of audio devices. You can connect headphones, a stereo system, or PA equipment for audio output, as well as input from a tone generator or other instrument.

**CAUTION** Be sure to turn off the power when connecting or disconnecting audio equipment, as failing to do so can result in damage to speakers and other problems.

### Headphones

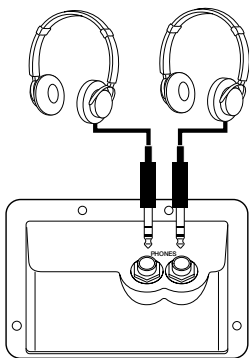

To use headphones, connect them to one of the [PHONES] jacks (standard 1/4" phone jacks) located below the left end of the keyboard. The Clavinova's built-in speaker system is automatically shut off when a pair of headphones are connected. Two people can enjoy listening to the Clavinova together by connecting two pairs of headphones to the two jacks.

#### NOTE

**Recommended Headphones:**  
Yamaha HPE-160 headphones

### Audio Input and Output

You can connect the Clavinova to a wide range of audio equipment by using the AUX IN and AUX OUT jacks, which are located at the left end of the unit on the rear panel.

#### AUX IN Jacks .....

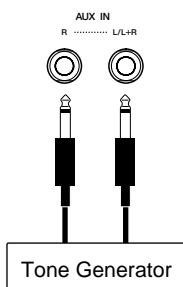

The sounds of other instruments or tone generator modules can be output through the speaker system of the Clavinova by connecting audio cables to the AUX IN jacks as shown here.

Use the AUX IN [L/L+R] jack for monophonic input. For stereo input, connect the left channel output to the AUX IN [L/L+R] jack, and the right channel output to the AUX IN [R] jack.

#### CAUTION

**Never connect the Clavinova's AUX OUT jacks to its AUX IN jacks, either directly or via external audio equipment. Such connections could result in a feedback loop that will make normal performance impossible, and may even damage the Clavinova.**

#### NOTE

The volume of the audio signal input at the AUX IN jacks is affected by the [MASTER VOLUME] slider.

### ■ AUX OUT Jacks .....

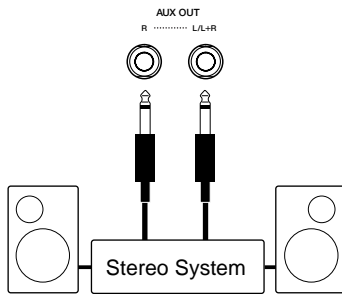

By connecting audio cables to the AUX OUT jacks as shown here, you can output the sound of the Clavinova to a stereo system, amplifier, mixing console, or recording equipment. Since the AUX OUT jacks provide output at a fixed level, you will need to use the controls on the connected equipment to adjust the overall volume of the sound from the Clavinova.

Use the AUX OUT [L/L+R] jack for monophonic output. For stereo output, connect the AUX OUT [L/L+R] jack to the left channel input, and the AUX OUT [R] jack to the right channel input.

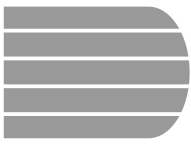

# Data Connections.....

You can use the MIDI terminals to connect your Clavinova to a wide range of MIDI devices, including personal computers, sequencers, tone generators, and so on. In addition, the Clavinova features a [TO HOST] connector that lets you connect it directly to an Apple Macintosh, IBM-PC/AT, or other compatible personal computer without the use of a special MIDI interface.

**CAUTION** Be sure to turn off the power when connecting or disconnecting computers or MIDI equipment, as failing to do so can result in damage to equipment.

## Connecting MIDI Equipment

Use MIDI cables to connect the MIDI terminals on the Clavinova to other MIDI devices. The Clavinova's MIDI terminals are located at the left of the unit on the rear panel.

Tone generators or other devices to be controlled by the Clavinova can be connected to the MIDI [OUT] terminal. Devices that will control the Clavinova should be connected to the MIDI [IN] terminal. If you have a personal computer or sequencer that will control the Clavinova, you may want to connect it to both the [IN] and [OUT] terminals to allow two-way communication. In this case, any other instruments to be controlled by the same device can be connected to the Clavinova's MIDI [THRU] terminal.

When you use the MIDI terminals, set the [HOST SELECT] switch to the MIDI position. The MIDI terminals will not transmit or receive data if this switch is set to any other position.

You can set the Clavinova's MIDI parameters using pages 9 through 12 of the FUNCTION display (see page 147 through 150).

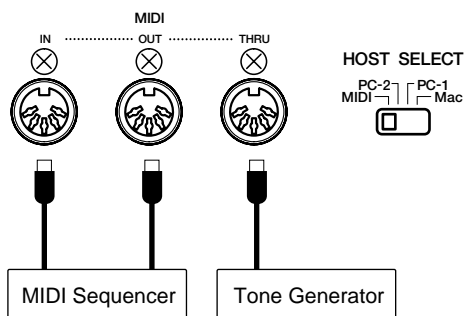

### NOTE

#### [TO HOST] or MIDI?

- If you simply want to connect your Clavinova to a personal computer, it may be more convenient to use the [TO HOST] terminal, as your computer won't need a special MIDI interface to make that connection.
- The MIDI terminals are particularly convenient when you want the Clavinova to function as part of a more extensive MIDI setup.

## Connecting to a Host Computer

You can connect the Clavinova to an Apple Macintosh, IBM-PC/AT, or compatible personal computer using the [TO HOST] connector, which is located at the left of the unit on the rear panel. If you do, be sure to set the adjacent [HOST SELECT] switch to the appropriate setting for your computer model.

### NOTE

- Turn off both the Clavinova and the computer before connecting the cable.
- When the Clavinova is connected to a host computer, turn on the computer first, then the Clavinova.
- Disconnect the cable when not using the [TO HOST] terminal. If it is left connected, the Clavinova may not function properly.



### ■ Connecting to an Apple Macintosh or Compatible Computer

Connect the [TO HOST] connector of the Clavinova to the modem or printer port on your Macintosh (whichever port your MIDI software is using for MIDI data communication) using a standard Macintosh 8-pin system peripheral cable. Set the [HOST SELECT] switch to the "Mac" position.

You may also have to make other MIDI interface settings on the computer side, depending on the type of software you use (refer to your software owner's manual). In any case, the clock speed should be set to 1 MHz.

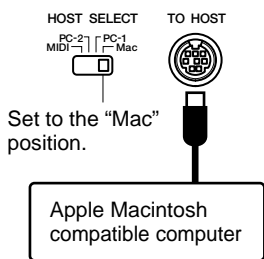

#### ● "Mac" Cable Connections

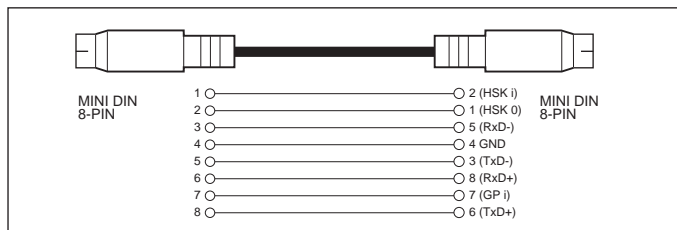

- 8-pin system peripheral cable
- Data transfer rate: 31,250 bps

### ■ Connecting to an IBM-PC/AT Series Computer

Connect the [TO HOST] connector of the Clavinova to the RS-232C port on your IBM computer, using a standard 8-pin MINI DIN → 9-pin D-SUB cross cable. Set the [HOST SELECT] switch to the "PC-2" position.

Refer to your software owner's manual for information on any settings you might have to make on the computer side.

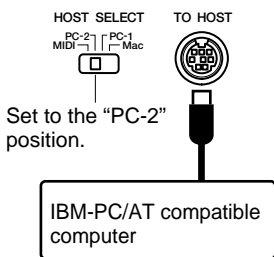

#### ● "PC-2" Cable Connections

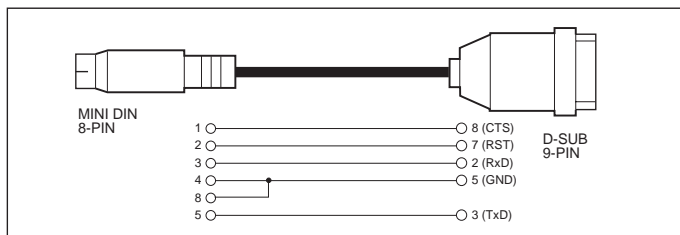

- 8-pin mini DIN → 9-pin D-SUB cable
- Data transfer rate: 38,400 bps

#### NOTE

*If your system doesn't work properly with the connections and settings listed above, your software may require different settings. Check your software operation manual: if it requires a 31,250 bps data transfer rate, set the [HOST SELECT] switch to "PC-1."*

#### ● Connector Pin Numbers

MINI DIN 8-PIN



D-SUB 9-PIN

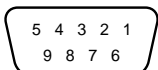

#### ● MIDI Driver

The Music Software Collection disk that came with your Clavinova contains special MIDI driver software intended for use with the Windows 95 and Windows 98 operating systems. This driver software may be necessary when using computer software with the Clavinova. Install the MIDI driver from the disk to your computer if necessary. Refer to the text files on the disks (listed below) for installation instructions.

A:\driver\readme\_e.txt

A:\driver\licensee.txt

"A:" is the name of the floppy disk drive.

# APPENDICES

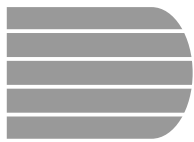

## Effect Type Lists .....

The tables in this appendix contain descriptions of the various reverb, chorus, and effect types that are available for use on the CVP-103.

### Reverb Type List

Type	Description
HALL1	Concert hall reverb effects
HALL2	
HALL3	
HALL4	
ROOM1	Small room reverb effects
ROOM2	
ROOM3	
ROOM4	
STAGE1	Reverb appropriate for a solo instrument
STAGE2	
PLATE1	Simulated steel plate reverb effects
PLATE2	

### Chorus Type List

Type	Description
CHORUS1	Standard chorus effects that add natural spaciousness to the sound
CHORUS2	
CHORUS3	
CHORUS4	
CHORUS5	
FLANGER1	Modulation effects reminiscent of a jet airplane taking off and landing
FLANGER2	
FLANGER3	
FLANGER4	

## Effect Type List

Type	Description
HALL1	Concert hall reverb effects
HALL2	
HALL3	
HALL4	
ROOM1	Small room reverb effects
ROOM2	
ROOM3	
ROOM4	
STAGE1	Reverb appropriate for a solo instrument
STAGE2	
PLATE1	Simulated steel plate reverb effects
PLATE2	
EARLY REF1	Early reflection components of the reverb effect
EARLY REF2	
GATE REVERB	Simulation of a gated reverb
REVERSE GATE	Simulation of a gated reverb played back in reverse
CHORUS1	Standard chorus effects that add natural spaciousness to the sound
CHORUS2	
CHORUS3	
CHORUS4	
CHORUS5	
FLANGER1	Modulation effects reminiscent of a jet airplane taking off and landing
FLANGER2	
FLANGER3	
FLANGER4	
SYMPHONIC	Multi-stage versions of the modulation provided by a celeste-type effect
PHASER	Modulation effect created by cyclical phase shifting
ROTARY SP1	Modulation effects that simulate rotary speakers
ROTARY SP2	
ROTARY SP3	
ROTARY SP4	
ROTARY SP5	
TREMOLO1	Cyclical volume modulation effects
TREMOLO2	
GTR TREMOLO	Tremolo effect that is suitable for guitar sounds
AUTO PAN	Effects that cyclically move the sound from right to left and front to back

## Effect Type List

<b>AUTO WAH</b>	Cyclical wah effects; useful for electric guitar sounds, etc.
<b>DELAY LCR</b>	Three delay sounds: L (left), R (right), and C (center)
<b>DELAY LR</b>	L and R delays with two feedback delays
<b>ECHO</b>	L and R delays with independent feedback for L and R
<b>CROSS DELAY</b>	Two delays (L and R) with crossed feedback
<b>DIST HARD</b>	Effects that add distortion with an edge to the sound; useful for electric guitar sounds, etc.
<b>DIST SOFT</b>	
<b>EQ DISCO</b>	Disco-oriented equalizer effect
<b>EQ TEL</b>	Equalizer effect that simulates sound heard over the phone

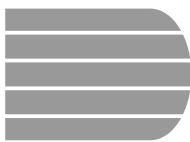

# Messages .....

## ● General (Panel Operation)











<p><b>i</b> This button can't be used during recording or playback!</p>	<p>This message appears when you try to perform an operation (such as song data conversion) that cannot be performed during recording or playback.</p> <ul style="list-style-type: none"> <li>&gt; Stop song recording or playback, or exit the Song Record or Song Play mode, then perform the operation again.</li> </ul>
<p><b>i</b> This button can't be used during playback!</p>	<p>This message appears when you try to perform an operation (such as selection of a style or Music Database setup) that cannot be performed during playback.</p> <ul style="list-style-type: none"> <li>&gt; Stop song playback, or exit the Song Play mode, then perform the operation again.</li> </ul>
<p><b>i</b> This button can't be used while recording!</p>	<p>This message appears when you try to perform an operation (such as copying or deletion of song data) that cannot be performed in the Song Record mode.</p> <ul style="list-style-type: none"> <li>&gt; Stop recording, or exit the Song Record mode, then perform the operation again.</li> </ul>
<p><b>i</b> Button not valid!</p>	<p>A button that does not have a function in the current mode has been pressed.</p>

## ● General (Direct Access)



<p><b>i</b> Press a button to display corresponding settings.</p>	<p>This prompt appears when you press the <b>[DIRECT ACCESS]</b> button (page 21).</p> <ul style="list-style-type: none"> <li>&gt; Press the panel button that corresponds to the settings you want to display. (Be sure to press the second button while this message is showing.)</li> </ul>
<p><b>i</b> DIRECT ACCESS not available for this function!</p>	<p>This message appears if you press <b>[DIRECT ACCESS]</b> followed by a panel button that does not correspond to a Direct Access display. (See page 21.)</p> <ul style="list-style-type: none"> <li>&gt; Press <b>[DIRECT ACCESS]</b> again, then press a panel button that corresponds to a Direct Access display.</li> </ul>



## ● General (Disk-related)

<p><b>i</b> No disk!</p>	<p>This prompt appears when there is no disk in the disk drive.</p> <ul style="list-style-type: none"> <li>&gt; Put the proper disk in the drive and attempt the operation again.</li> </ul>
<p><b>i</b> No songs!</p>	<p>This prompt appears when you attempt to rename or convert a song that doesn't contain any data.</p> <ul style="list-style-type: none"> <li>&gt; Select a song that contains data, or insert a disk with song data into the floppy disk drive.</li> </ul>
<p><b>i</b> No file!</p>	<p>This message appears when you attempt to load, rename, or delete a file, and no file of the specified type can be found on the disk in the disk drive.</p> <ul style="list-style-type: none"> <li>&gt; Create a file or insert a disk with a proper file.</li> </ul>
<p><b>i</b> No data to save!</p>	<p>This message appears if you try to save a custom style to disk (page 82), but have selected a memory number that doesn't contain any style data.</p> <ul style="list-style-type: none"> <li>&gt; Create a custom style, or select a memory number that contains custom style data.</li> </ul>
<p><b>?</b> Start disk format?  <input type="button" value="OK"/> <input type="button" value="CANCEL"/></p>	<p>This message appears when a new or improperly formatted disk has been inserted into the disk drive. (See page 111.)</p> <ul style="list-style-type: none"> <li>&gt; Press <b>OK</b> if you want to format the disk. Press <b>CANCEL</b> if you want to abort the formatting process.</li> </ul>
<p><b>i</b> Protected disk!</p>	<p>This message appears when you attempt to record or perform other file operations using a disk whose write-protect tab is in the "protect" position.</p> <ul style="list-style-type: none"> <li>&gt; Set the write-protect tab to the "write-enable" position (page 112), then try the operation again. If the operation still cannot be performed, the disk itself has internal write protection, making it impossible to perform recording or file operations on the disk.</li> </ul>















 <b>Protected songs!</b>	<p>This message appears when you attempt to record over parts or perform other operations on song files that are incompatible or do not allow such operations. Depending on the song file type, operations such as additional recording, copying, deleting, etc. may not be possible using the CVP-103.</p>
 <b>Disk read/write error!</b> <input type="button" value="OK"/>	<p>An error occurred while writing to (as in recording or storing files) or reading from the disk.</p> <ul style="list-style-type: none"> <li>➤ Try the operation again after pressing the <b>OK</b> button. If the error occurs a second time, the disk or the disk drive unit may be faulty. If you suspect the drive to be at fault, refer the problem to your Yamaha dealer.</li> </ul>
 <b>Completed!</b>	<p>This appears for a few seconds when a time-consuming operation such as Format, Song Copy, etc., is finished.</p>
 <b>Don't remove the disk!</b>	<p>This message is displayed while data is being transferred between the Clavinova and the disk.</p> <ul style="list-style-type: none"> <li>➤ The message disappears automatically when the operation is finished.</li> </ul>
 <b>Are you sure?</b> <input type="button" value="YES"/> <input type="button" value="NO"/>	<p>When operations such as Song Delete or Format are selected, this prompts you to confirm whether you want to go ahead with the operation or not.</p> <ul style="list-style-type: none"> <li>➤ Press <b>YES</b> to execute the operation. Press <b>NO</b> to return to the previous display.</li> </ul>
 <b>Disk full!</b> <input type="button" value="OK"/>	<p>The currently loaded disk is full and cannot hold any more data.</p> <ul style="list-style-type: none"> <li>➤ Press the <b>OK</b> button, then delete any unnecessary data in the disk (page 144), or use a disk that has more available space. If this message appears during song recording, recording will stop and any data recorded up to that point will be saved automatically.</li> </ul>
 <b>Too many files!</b> <input type="button" value="OK"/>	<p>This message appears when you try to create more files than the disk is capable of storing. You can record up to 60 song files on a 2DD or 2HD disk. A 2DD disk can hold about 107 files (of various types), and a 2HD disk can hold up to about 219 files.</p> <ul style="list-style-type: none"> <li>➤ Press the <b>OK</b> button, then delete any unnecessary files from the disk (page 144), or use a disk that has more available space.</li> </ul>
 <b>Same name! Overwrite?</b> <input type="button" value="OK"/> <input type="button" value="CANCEL"/>	<p>A file with the same name already exists.</p> <ul style="list-style-type: none"> <li>➤ Press the <b>OK</b> button if you wish to overwrite the original file with new data, or press <b>CANCEL</b> to abort the operation.</li> </ul>
 <b>Disk read/write operation in process!</b>	<p>This message appears when you try to execute other operations while reading data from the disk or saving data.</p> <ul style="list-style-type: none"> <li>➤ Wait until the data read/write operation is completed, then perform the operation again.</li> </ul>
 <b>Convert to CVP songs?</b> <input type="button" value="YES"/> <input type="button" value="NO"/>	<p>This message appears when you attempt to record over or edit the data of commercially available software or data recorded on instruments other than the CVP-109/107/105/103 or the CVP-94/92/98/96/600.</p> <ul style="list-style-type: none"> <li>➤ Press <b>YES</b> to convert the data for recording or editing on the CVP-109/107/105/103. Press <b>NO</b> if you don't want to convert the data. It may not be possible to record to tracks other than tracks 1 and 2 of songs converted in this manner.</li> </ul>

## ● General (Memory-related)

 <b>Not enough memory!</b> <input type="button" value="OK"/>	<p>This message appears when the Clavinova's memory has become full while recording a song in the internal memory (page 133). If this happens, recording will stop and any data recorded up to that point will be saved automatically.</p> <p>This message is also displayed if the Clavinova's memory becomes full when recording data in a custom style (see page 84).</p>
 <b>Memory write operation in process!</b>	<p>This message appears while the Clavinova is storing the data of a song recorded to the internal memory after it has been edited using the Track Edit or Initial Edit functions.</p> <ul style="list-style-type: none"> <li>➤ Complete the data write operation, then perform the other operation.</li> </ul>

 Delete CVP MEMORY? <input type="button" value="YES"/> <input type="button" value="NO"/>	<p>This message appears when you execute an operation, such as playback of disk software, that will cause the Clavinova to delete data recorded to the internal memory.</p> <p>&gt; Press <b>YES</b> to delete the data recorded to the internal memory, then perform the desired operation. Press the <b>NO</b> button if you want to keep the data.</p>
 This button can't be used for CVP MEMORY!	<p>This message appears if you try to select one of the following functions while editing song data that has been recorded to the internal memory: Chord Sequence (page 121), Setup Memory (126), or Song Name (page 127).</p> <p>&gt; Use the Song Copy function (page 142) to copy the song to a disk, delete the <b>CVP MEMORY</b> song (page 144), then perform the desired operation using the data on the disk.</p>

## ● Custom Style Mode

 CUSTOM STYLE Select a source style.	<p>This message appears for a few seconds when the Custom Style mode is engaged. (See page 74.)</p>
 Clear style? <input type="button" value="OK"/> <input type="button" value="CANCEL"/>	<p>This confirmation prompt appears when you attempt to change the time signature of the custom style. (See page 75.)</p>
 Clear section? <input type="button" value="OK"/> <input type="button" value="CANCEL"/>	<p>This confirmation prompt appears when you attempt to change the number of measures in a section of the custom style. (See page 75.)</p>
 Clear part? <input type="button" value="OK"/> <input type="button" value="CANCEL"/>	<p>This confirmation prompt appears when you attempt to perform an operation that can only be performed after the part has been deleted. (See page 76.)</p>
 Store Bossa NovaX?  <input type="button" value="OK"/> <input type="button" value="CANCEL"/>	<p>This confirmation prompt appears when you store a custom style (page 79). It also appears if you try to change styles before you've stored the custom style (page 85).</p> <p>&gt; Select <b>OK</b> to store the custom style. Press <b>CANCEL</b> to return to the previous display without storing data.</p>
 Store Bossa NovaX?  <input type="button" value="YES"/> <input type="button" value="NO"/> <input type="button" value="CANCEL"/>	<p>This confirmation prompt appears when you attempt to exit the Custom Style mode before storing the custom style. (See page 85.)</p> <p>&gt; Select <b>YES</b> to store the custom style. Press <b>NO</b> to exit without storing. Press <b>CANCEL</b> to return to the previous display.</p>
 Can't recall! <input type="button" value="OK"/>	<p>This message appears when the previous version of the custom style cannot be recalled because the time signature has been changed. (See page 80.)</p>
 Store in memory before saving to disk. <input type="button" value="OK"/>	<p>If you attempt to save a custom style to disk before storing it in memory, this message prompts you to store the style before proceeding. (See page 83.)</p>
 Not enough memory! Delete an unneeded style or simplify the current style. <input type="button" value="DELETE"/> <input type="button" value="CANCEL"/>	<p>This message appears if there is not enough internal memory capacity available to store the custom style. (See page 84.)</p>
 Select style to delete.  <input type="button" value="OK"/> <input type="button" value="CANCEL"/>	<p>This message appears when <b>DELETE</b> is selected in the display shown above.</p> <p>&gt; Select the style to be deleted and press the <b>OK</b> button. Press <b>CANCEL</b> if you do not want to delete the style.</p>
 Can't delete this style! <input type="button" value="OK"/>	<p>This message appears if the style selected for deletion in the display shown above is the source style on which the style currently being edited was based.</p> <p>&gt; Press <b>OK</b> to return to the preceding display, and select a different style for deletion.</p>

## ● Style File Load

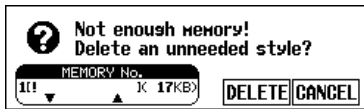

This message appears if you attempt to load a Style file when the memory capacity is not sufficient to hold the specified file. (See page 87.)



Some Style files are too large to be handled by the **LISTEN** function. (See page 87.)

- Load the Style file, then use the normal playback methods to hear the style in question.

## ● Chord Sequence

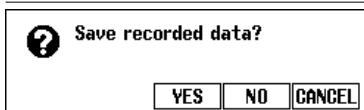

This confirmation message appears if you attempt to exit the Chord Sequence function while recording.

- Press **YES** to store the recorded data. Press **NO** to exit without storing. Press **CANCEL** to return to the Chord Sequence function without storing.

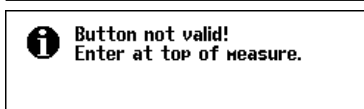

This message appears during Chord Sequence recording when you attempt to enter an accompaniment style or section change at a position other than the beginning of a measure.

- Record the style or section change in question at the beginning of the measure. (See page 122.)

## ● Other Record Edit

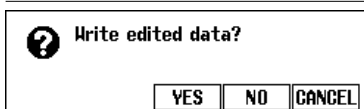

This confirmation message appears if you attempt to exit the Initial Edit function without writing the data to disk.

- Press **YES** to save the edited data. Press **NO** to exit without saving. Press **CANCEL** to return to the Initial Edit display without saving.

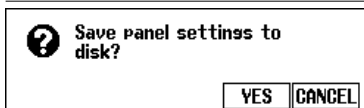

This confirmation prompt appears when you execute the Setup Memory function (page 126) to save the current panel settings with the song being edited in Song Record mode.

- Select **YES** to save the panel settings. Press **CANCEL** to return to the RECORD EDIT 2 display without saving.

## ● Song Copy & Disk Copy

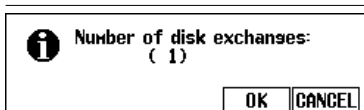

This message appears before you start a Song Copy or Disk Copy operation to inform you of the number of times the disks must be exchanged. (See page 143.)

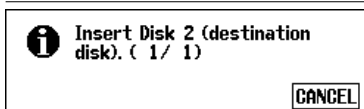

This message prompts you to insert the destination disk when copying data from one disk to another. (See page 143.)

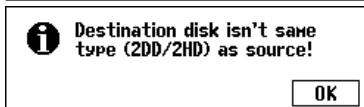

This message appears when you try to copy data from a 2DD disk to a 2HD disk — or vice versa — using the Disk Copy function (page 142).



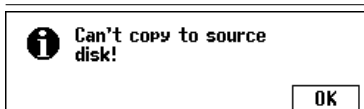



- Press **OK** to cancel the copy operation, then perform the operation again from the beginning. Make sure the destination disk you insert is the same type (2DD or 2HD) as the source disk being copied.





This message appears if you insert the source disk when prompted to insert the destination disk while using the Disk Copy function (page 143) to copy data from one disk to another.

- Press **OK** to cancel the copy operation, then execute the Disk Copy function again from the beginning. When exchanging disks during the copy operation, be careful not to confuse the source and destination disks.





 <p>Select destination song number.</p> 	<p>When you first insert the destination disk while copying a song from one disk to another disk, this message prompts you to specify the song number to which the song is to be copied. (See page 143.)</p>
 <p>Insert Disk 1 (source disk). ( 2 / 9 )</p> 	<p>This message prompts you to insert the source disk when copying data from one disk to another. (See page 143.)</p>
 <p>Incorrect disk!</p> 	<p>This message is displayed if you insert a disk other than the specified disk (source or destination) when prompted to exchange disks while using the Disk Copy function (page 143) to copy data from one disk to another.</p> <ul style="list-style-type: none"> <li>➤ Press <b>OK</b> to cancel the copy operation, then execute the Disk Copy function again from the beginning. When exchanging disks during the copy operation, be careful to insert the correct disk as specified.</li> </ul>
 <p>Select a different song number!</p>	<p>This message indicates that you have selected the same song number as both the source and the destination when copying a song within a disk. (See sidebar, page 143.)</p> <ul style="list-style-type: none"> <li>➤ Change the destination song number.</li> </ul>

## ● Song Data Conversion

 <p>2HD disk not valid! Copy to 2DD disk.</p> 	<p>This message appears if you attempt to convert song data that has been saved on a 2HD disk. (See page 145.)</p> <ul style="list-style-type: none"> <li>➤ Press <b>OK</b> and copy the song data to be converted to a 2DD disk, then perform the data conversion using the 2DD disk.</li> </ul>
 <p>Completed ! Song No. 1</p>	<p>Following conversion of the song data, this message displays the song number to which the data was saved.</p>

## ● Hardware-related

 <p>Host is offline!</p>	<p>This message appears when the host computer is not turned on, the connecting cable is not properly connected, the HOST SELECT switch is not in the proper position, or the MIDI driver or MIDI application is not active.</p> <ul style="list-style-type: none"> <li>➤ Turn off both the Clavinova and the host computer. Check the cable connection and the position of the HOST SELECT switch (page 160), then turn on the computer first, followed by the Clavinova.</li> </ul>
 <p>Back up data erased and replaced by factory data.</p>	<p>The Clavinova will retain data protected by the Backup function (page 152) as long as it is used regularly. If the instrument is not turned on for a week or longer, however, the data may be lost. This message appears when the Clavinova is turned on after data has been lost. It also appears when you recall all factory data (page 153.)</p>

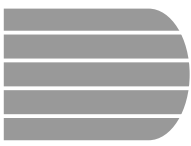

# Troubleshooting.....

Problem	Cause	Solution
The Clavinova does not turn on.	The Clavinova has not been plugged in properly.	Securely insert the female plug into the socket on the Clavinova, and the male plug into a proper AC outlet.
A click or pop is heard when the power is turned on or off.	Electrical current is being applied to the instrument.	This is normal, and is no cause for concern.
Noise is heard from the Clavinova's speakers.	The noise may be due to interference caused by the use of a mobile phone in close proximity to the Clavinova.	Turn off the mobile phone, or use it further away from the Clavinova.
The display is too bright or too dark to read.	The brightness may be affected by the surrounding temperature.	Adjust the contrast of the display using the <b>[CONTRAST]</b> control. (See page 11.)
The keyboard volume is low compared to that of the Auto Accompaniment or song playback.	Either the overall keyboard volume or the independent volume level of the keyboard part is set too low.	Increase the overall keyboard level in the main display (page 23), or use the <b>VOLUME</b> function in the appropriate <b>KEYBOARD</b> display (pages 32, 34, or 37) to raise the volume of the keyboard part in question.
The volume of the Auto Accompaniment or song playback is low compared to that of the keyboard.	The <b>[ACMP/SONG VOLUME]</b> is set too low.	Raise the <b>[ACMP/SONG VOLUME]</b> level.
	The volume level of one or more accompaniment parts or song tracks is set too low.	Raise the part or track level(s) in the appropriate <b>MIXER</b> display (page 65 or 100).
The overall volume is low, or no sound is heard.	The <b>[MASTER VOLUME]</b> is set too low.	Raise the <b>[MASTER VOLUME]</b> level.
	Headphones are connected.	Unplug the headphones.
	The Local Control function is turned off.	Turn the Local Control function on. (See page 147.)
The damper pedal has no effect, or the sound continuously sustains even when the damper pedal is not pressed.	The pedal cord plug is not connected.	Securely insert the pedal cord plug into the proper jack. (See page 42 in the Reference booklet.)
Style or song playback does not start.	The MIDI Sync function is set to EXT.	Set the MIDI Sync function to INT. (See page 148.)
When the keyboard is played, not all of the notes sound.	The Clavinova's total simultaneous polyphonic capacity (maximum number of notes) has been exceeded.	Since the configuration of the tone generation system is such that later notes have priority, previous notes may occasionally be cut off. (See "Specifications" in the Reference Booklet for details about the simultaneous polyphonic capacity.)

Problem	Cause	Solution
The Auto Accompaniment does not play back.	The Auto Accompaniment is not turned on.	Press the [ <b>ACMP ON</b> ] button to turn on the Auto Accompaniment.
The desired chord is not recognized or output by the Auto Accompaniment.	The keys are not being played correctly.	Refer to the Fingering Chart (page 15 of the Reference Booklet).
	The keys are not being played according to the selected accompaniment mode.	Check the accompaniment mode, and play the keys according to the selected mode. (See page 59.)
The maximum of 60 songs cannot be recorded.	The memory capacity is full because the playing time of one or more songs is long, or many functions were used.	Delete unnecessary songs (page 144) or record to a new disk.
Some tracks do not play back when playing back data.	Playback of the track(s) is turned off.	Turn on playback for the tracks that you want to hear. (See pages 97 and 100.)

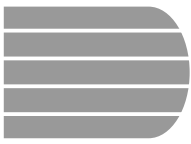

# MIDI and Data Compatibility.....

## ■ MIDI

MIDI (Musical Instrument Digital Interface) is a worldwide standard communication interface that allows MIDI-compatible musical instruments and equipment to share musical information and control one another.

- Depending on the MIDI device, the transmittable/receivable data differs, and only data which is commonly recognized among the connected MIDI devices can be transmitted or received. You can check whether your instrument supports certain data types by referring to the MIDI Implementation Chart in the owner's manual for that instrument. The MIDI Implementation Chart for the CVP-103 is found on page 38 in the Reference Booklet.

### MIDI Terminals

Data received via the MIDI IN terminal is re-transmitted unchanged through this terminal.

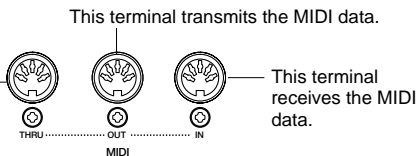

### MIDI Cable

Connect MIDI devices with special MIDI cables.

- MIDI settings can be made in the MIDI pages of the Function mode display. (See pages 147 through 150.)
- Further information on MIDI and its applications is available in various music books and magazines.

## ■ Data Compatibility

This section covers basic information on data compatibility: whether or not other MIDI devices can playback the data recorded by CVP-103, and whether or not the CVP-103 can playback commercially available song data or song data created for other instruments or on a computer.

Depending on the MIDI device or data characteristics, you may be able to play back the data without any problem, or you may have to perform some special operations before the data can be played back. If you run into problems playing back data, please refer to the information below.

### ● Basic Check Points

The data and the MIDI device must match in regards to the items below.

- Disk Format
- Sequence format
- Voice allocation format

### ● Disk format

Floppy disks are the main storage medium for data used with various devices, including computers. Different devices have different systems of storing data, therefore it is necessary to first configure the floppy disk to the system of the device being used. This operation is called "formatting."

- There are two types of floppy disks: MF2DD (double sided, double density) and MF2HD (double sided, high density), and each type has different formatting systems.
- CVP-103 can record and playback with both types of floppy disks.
- When formatted by the CVP-103, a 2DD disk stores up to 720 KB (kilobytes) and a 2HD disk stores up to 1.44 MB (megabytes). (The figures "720 KB" and "1.44 MB" indicate the data memory capacity. They are also used to indicate the format type of disk.)
- Playback is only possible when the MIDI device to be used is compatible with the format of the disk.

### ● Sequence Format

The system which records song data is called "sequence format."

- Playback is only possible when the sequence format of the disk matches that of the MIDI device.

#### [Common Sequence Formats]

##### SMF (Standard MIDI File)

This is the most common sequence format.

- Standard MIDI Files are generally available as one of two types: Format 0 or Format 1.
- Many MIDI devices are compatible with Format 0, and most commercially available software is recorded as Format 0.
- The CVP-103 is compatible with both Format 0 and Format 1 (for Format 1, up to a maximum of 17 chunks).
- Song data recorded on the CVP-103 is automatically recorded as SMF Format 0.

##### ESEQ

This sequence format is compatible with many of Yamaha's MIDI devices, including the Clavinova series instruments.

This is a common format used with various Yamaha software.

- The CVP-103 is compatible with ESEQ.

### ● Voice Allocation Format

With MIDI, voices are assigned to specific numbers, called "program numbers." The numbering standard (order of voice allocation) is referred to as the "voice allocation format."

- Voices may not play back as expected unless the voice allocation format of the song data matches that of the compatible MIDI device used for playback.

#### [Main Voice Allocation Formats]

##### GM System Level 1

This is one of the most common voice allocation formats.

- Many MIDI devices are compatible with GM System Level 1, as is most commercially available software.
- The CVP-103 is compatible with GM System Level 1.

##### XG

XG is a major enhancement of the GM System Level 1 format, and was developed by Yamaha specifically to provide more voices and variations, as well as greater expressive control over voices and effects, and to ensure compatibility of data well into the future.

- The CVP-103 is compatible with XG.
- Song data recorded on the CVP-103 using voices in the [XG] category is XG-compatible.

##### DOC

This voice allocation format is compatible with many of Yamaha's MIDI devices, including the Clavinova series instruments.

This is also a common format used with various Yamaha software.

- The CVP-103 is compatible with DOC.

Even if the devices and data used satisfy all the conditions above, the data may still not be completely compatible, depending on the specifications of the devices and particular data recording methods.



# Index

## A

Accompaniment Mode ..... 57, 59-61  
 accompaniment styles ..... see "styles"  
 All Setup files ..... 139-141  
 audio connections ..... 158-159  
 Auto Accompaniment ..... 57-72

## B

Backup ..... 152  
 basic settings ..... 19  
 beat ..... 26, 74-75

## C

channels, MIDI ..... 147, 150-151  
 Chord Assistance ..... 62-64  
 chord indication ..... 60-61  
 Chord Sequence ..... 121-125  
 chorus ..... 44-45  
 chorus, Custom Style ..... 81-82  
 chorus, Song ..... 100-101  
 Chorus Type List ..... 162  
 computer ..... 160-161  
 contrast ..... 11  
 controls ..... 12-13  
 convert, song data ..... 145  
 Custom Style ..... 73-88  
 CVP MEMORY (song) ..... 133

## D

damper pedal ..... 40, 138  
 data dial ..... 17  
 deleting, Chord Sequence ..... 124  
 deleting, data files ..... 141  
 deleting, Style Files ..... 83  
 deleting, tracks ..... 129  
 Demo Play ..... 14-15  
 detune ..... 35  
 Direct Access ..... 22  
 Disk Copy ..... 142-143  
 disk drive ..... 9  
 Disk Format ..... 111, 146  
 Disk functions ..... 139-146  
 display pages ..... 19  
 Dual ..... 33-35

## E

Easy Play ..... 105, 107  
 Effect Type List ..... 163-164  
 effects ..... 46-48  
 effects, Song ..... 100-101  
 end mark ..... 124, 125  
 ending pattern ..... 55-56

## F

Fade In ..... 55  
 Fade Out ..... 56  
 fast forward ..... 103  
 file icons ..... 94  
 fill-in patterns ..... 51-52  
 filter, MIDI Filter ..... 148-150  
 fingering (chords) ..... 60-61, 62-64  
 Fixed Velocity ..... 137  
 floppy disks ..... 9  
 formatting, Disk ..... 111, 146  
 free tempo ..... 96  
 Function ..... 134-135  
 function, resetting ..... 19-20  
 functions in normal rectangles ..... 20-21  
 functions in rounded rectangles ..... 16

## G

Glide Range ..... 138  
 Guide ..... 15, 105-109  
 guide lamps ..... 109  
 Guide Mode ..... 108

## H

Harmony ..... 69-71  
 headphones ..... 11, 158  
 Help ..... 27-28  
 host computer ..... 160-161  
 highlighted items ..... 16

## I

Initial Edit ..... 130-132  
 introduction pattern ..... 54

## K

key cover ..... 10  
 Key Touch ..... 137  
 keyboard guide lamps ..... 109  
 keyboard percussion ..... 31

## L

LCD, changing a value ..... 17  
 LCD, selecting a function ..... 16  
 Left Pedal ..... 138  
 left voice ..... 36-39  
 loading, data files ..... 140  
 loading, style files ..... 86-88  
 Local Control ..... 147  
 lyrics ..... 15, 109

## M

main display ..... 16  
 main voice ..... 29-32, 33, 36  
 memory, recording to ..... 133  
 menu display ..... 18  
 messages ..... 165-169  
 messages, Custom Style ..... 84-85  
 metronome ..... 25-26  
 Micro Tuning ..... 154-155  
 MIDI equipment ..... 160  
 MIDI Filter ..... 148-149  
 MIDI functions ..... 147-151  
 MIDI terminals ..... 160  
 MIDI Transpose ..... 150  
 Mixer, Auto Accompaniment ..... 65-66  
 Mixer, Song ..... 100-101  
 multi-track recording ..... 115-118  
 Music Database ..... 67-68  
 music stand ..... 10

## N

naming, Custom Style ..... 78-79  
 naming, data files ..... 141  
 naming, Song ..... 127  
 Next Note ..... 105, 107

## O

octave ..... 32, 34, 38  
 One Touch Setting ..... 72

## P

pages, display ..... 19  
 pan 32, 35, 38  
 pan, Custom Style ..... 81-82  
 pan, Song ..... 100-101  
 panel controls ..... 12-13  
 part, recording ..... 76-78  
 part, track assignment ..... 98-99  
 Part Cancel ..... 97-98  
 part levels ..... 65-66, 81-82  
 pause ..... 103  
 Pedal functions ..... 138  
 pedals ..... 38, 40  
 Pianist styles ..... 49, 58  
 Piano Roll ..... 106, 107, 109  
 playback, Auto Accompaniment ..... 58, 60-61  
 playback, Custom Style ..... 84  
 Playback, demo songs ..... 14-15  
 playback, Song ..... 93-104  
 playback, styles ..... 51-56  
 playback, style files ..... 88  
 power ..... 11  
 practicing ..... 105-107  
 preset scale ..... 155-156  
 Punch-in/out Recording ..... 118-120

## Q

quantizing ..... 78, 129-130  
 Quick Recording ..... 112-115

## R

Recall ..... 153  
 Recall Section ..... 80  
 recalling, registration ..... 90-91  
 Receive Filter ..... 149-150  
 Record Edit functions ..... 126-132  
 recording, Chord Sequence ..... 121-125  
 recording, Custom Style ..... 73-80  
 recording, Song ..... 110-120  
 recording, without a disk ..... 133  
 Registration ..... 89-92  
 Registration file ..... 139-141  
 Registration Freeze ..... 91-92  
 Remote Keyboard ..... 151  
 Repeat ..... 101-103  
 Reverb ..... 41-43  
 reverb, Custom Style ..... 81-82  
 reverb, Song ..... 100-101  
 Reverb Type List ..... 162  
 rewind ..... 103  
 Rhythm On/Off ..... 125

## S

saving, Custom Style ..... 82-83  
 saving, data files ..... 140-141  
 saving, Initial Edit ..... 132  
 Scale Tuning ..... 155-157  
 second voice ..... 33-35  
 section ..... 74-75, 80  
 Send Channel ..... 147, 150-151  
 Setup files ..... 139-141  
 Setup Memory ..... 126-127  
 setup procedure ..... 10  
 soft pedal ..... 40, 138  
 software ..... 104  
 song, Chord Sequence ..... 121-125  
 Song Copy ..... 142-143  
 Song Data Transform ..... 145  
 Song Delete ..... 144  
 Song Name ..... 127  
 Song Play ..... 93-104  
 Song Record ..... 110-120  
 Song Transmission ..... 151  
 sostenuto pedal ..... 40  
 Sound Repeat ..... 106, 107, 109  
 Split ..... 36-39  
 Split Point ..... 36, 39, 64  
 stereo position ..... see "pan"  
 storing, Custom Style ..... 79-80  
 storing, Registration ..... 89-90

Style Clear ..... 80  
 style file ..... 86-88  
 styles, custom ..... 73-88  
 styles, playback ..... 51-56  
 styles, selecting ..... 49-50  
 Synchronization (MIDI) ..... 148  
 Synchronized Start ..... 53  
 Synchronized Stop ..... 62

## T

Tap Start ..... 53  
 tempo ..... 25, 96, 100  
 terminals and jacks ..... 12-13  
 time signature ..... 26, 74-75  
 Track Delete ..... 129  
 Track Edit ..... 128-130  
 Track Mix ..... 128  
 Track Recording ..... 115-118  
 Track Quantize ..... 129-130  
 tracks, adding ..... 118  
 tracks, song structure ..... 110  
 Transform ..... 145  
 Transpose ..... 136, 150  
 troubleshooting ..... 170-171  
 Tune ..... 136, 156

## U

user scale ..... 156-157

## V

velocity ..... 137  
 Voice Setting ..... 137  
 voices, selecting ..... 29-30, 76, 99  
 volume ..... 23-24  
 volume, metromome ..... 26  
 volume, part ..... 65-66, 81-82  
 volume, song ..... 99  
 volume, track ..... 100-101  
 volume, voices ..... 32, 34, 37

## FCC INFORMATION (U.S.A.)

### 1. IMPORTANT NOTICE: DO NOT MODIFY THIS UNIT!

This product, when installed as indicated in the instructions contained in this manual, meets FCC requirements. Modifications not expressly approved by Yamaha may void your authority, granted by the FCC, to use the product.

### 2. IMPORTANT:

When connecting this product to accessories and/or another product use only high quality shielded cables. Cable/s supplied with this product MUST be used. Follow all installation instructions. Failure to follow instructions could void your FCC authorization to use this product in the USA.

### 3. NOTE:

This product has been tested and found to comply with the requirements listed in FCC Regulations, Part 15 for Class "B" digital devices. Compliance with these requirements provides a reasonable level of assurance that your use of this product in a residential environment will not result in harmful interference with other electronic devices. This equipment generates/uses radio frequencies and, if not installed and used according to the instructions found in the users manual, may cause interference harmful to the operation of other electronic devices. Compliance with FCC

regulations does not guarantee that interference will not occur in all installations. If this product is found to be the source of interference, which can be determined by turning the unit "OFF" and "ON", please try to eliminate the problem by using one of the following measures:

Relocate either this product or the device that is being affected by the interference.

Utilize power outlets that are on different branch (circuit breaker or fuse) circuits or install AC line filter/s.

In the case of radio or TV interference, relocate/reorient the antenna. If the antenna lead-in is 300 ohm ribbon lead, change the lead-in to co-axial type cable.

If these corrective measures do not produce satisfactory results, please contact the local retailer authorized to distribute this type of product. If you can not locate the appropriate retailer, please contact Yamaha Corporation of America, Electronic Service Division, 6600 Orangethorpe Ave, Buena Park, CA90620

The above statements apply ONLY to those products distributed by Yamaha Corporation of America or its subsidiaries.

\* This applies only to products distributed by YAMAHA CORPORATION OF AMERICA.

(class B)

### IMPORTANT NOTICE FOR THE UNITED KINGDOM Connecting the Plug and Cord

IMPORTANT. The wires in this mains lead are coloured in accordance with the following code:

BLUE : NEUTRAL  
BROWN : LIVE

As the colours of the wires in the mains lead of this apparatus may not correspond with the coloured markings identifying the terminals in your plug proceed as follows:

The wire which is coloured BLUE must be connected to the terminal which is marked with the letter N or coloured BLACK.

The wire which is coloured BROWN must be connected to the terminal which is marked with the letter L or coloured RED.

Making sure that neither core is connected to the earth terminal of the three pin plug.

(2 wires)

- This applies only to products distributed by Yamaha-Kemble Music (U.K.) Ltd.

**CAUTION:** TO PREVENT ELECTRIC SHOCK, MATCH WIDE BLADE OF PLUG TO WIDE SLOT, FULLY INSERT.

**ATTENTION:** POUR ÉVITER LES CHOCS ÉLECTRIQUES, INTRODUIRE LA LAME LA PLUS LARGE DE LA FICHE DANS LA BORNE CORRESPONDANTE DE LA PRISE ET POUSSER JUSQU'AU FOND.

(polarity)

- This applies only to products distributed by Yamaha Canada Music Ltd.
- Ceci ne s'applique qu'aux produits distribués par Yamaha Canada Musique Ltée.

# IMPORTANT SAFETY INSTRUCTIONS

## INFORMATION RELATING TO PERSONAL INJURY, ELECTRICAL SHOCK, AND FIRE HAZARD POSSIBILITIES HAS BEEN INCLUDED IN THIS LIST.

**WARNING-** When using any electrical or electronic product, basic precautions should always be followed. These precautions include, but are not limited to, the following:

- 1.** Read all Safety Instructions, Installation Instructions, Special Message Section items, and any Assembly Instructions found in this manual **BEFORE** making any connections, including connection to the main supply.
- 2.** **Main Power Supply Verification:** Yamaha products are manufactured specifically for the supply voltage in the area where they are to be sold. If you should move, or if any doubt exists about the supply voltage in your area, please contact your dealer for supply voltage verification and (if applicable) instructions. The required supply voltage is printed on the name plate. For name plate location, please refer to the graphic found in the Special Message Section of this manual.
- 3.** This product may be equipped with a polarized plug (one blade wider than the other). If you are unable to insert the plug into the outlet, turn the plug over and try again. If the problem persists, contact an electrician to have the obsolete outlet replaced. Do **NOT** defeat the safety purpose of the plug.
- 4.** Some electronic products utilize external power supplies or adapters. Do **NOT** connect this type of product to any power supply or adapter other than one described in the owners manual, on the name plate, or specifically recommended by Yamaha.
- 5.** **WARNING:** Do not place this product or any other objects on the power cord or place it in a position where anyone could walk on, trip over, or roll anything over power or connecting cords of any kind. The use of an extension cord is not recommended! If you must use an extension cord, the minimum wire size for a 25' cord (or less) is 18 AWG. **NOTE:** The smaller the AWG number, the larger the current handling capacity. For longer extension cords, consult a local electrician.
- 6.** **Ventilation:** Electronic products, unless specifically designed for enclosed installations, should be placed in locations that do not interfere with proper ventilation. If instructions for enclosed installations are not provided, it must be assumed that unobstructed ventilation is required.
- 7.** **Temperature considerations:** Electronic products should be installed in locations that do not significantly contribute to their operating temperature. Placement of this product close to heat sources such as; radiators, heat registers and other devices that produce heat should be avoided.
- 8.** This product was **NOT** designed for use in wet/damp locations and should not be used near water or exposed to rain. Examples of wet/damp locations are; near a swimming pool, spa, tub, sink, or wet basement.
- 9.** This product should be used only with the components supplied or; a cart, rack, or stand that is recommended by the manufacturer. If a cart, rack, or stand is used, please observe all safety markings and instructions that accompany the accessory product.
- 10.** The power supply cord (plug) should be disconnected from the outlet when electronic products are to be left unused for extended periods of time. Cords should also be disconnected when there is a high probability of lightning and/or electrical storm activity.
- 11.** Care should be taken that objects do not fall and liquids are not spilled into the enclosure through any openings that may exist.
- 12.** Electrical/electronic products should be serviced by a qualified service person when:
  - a. The power supply cord has been damaged; or
  - b. Objects have fallen, been inserted, or liquids have been spilled into the enclosure through openings; or
  - c. The product has been exposed to rain; or
  - d. The product does not operate, exhibits a marked change in performance; or
  - e. The product has been dropped, or the enclosure of the product has been damaged.
- 13.** Do not attempt to service this product beyond that described in the user-maintenance instructions. All other servicing should be referred to qualified service personnel.
- 14.** This product, either alone or in combination with an amplifier and headphones or speaker/s, may be capable of producing sound levels that could cause permanent hearing loss. **DO NOT** operate for a long period of time at a high volume level or at a level that is uncomfortable. If you experience any hearing loss or ringing in the ears, you should consult an audiologist. **IMPORTANT:** The louder the sound, the shorter the time period before damage occurs.
- 15.** Some Yamaha products may have benches and/or accessory mounting fixtures that are either supplied as a part of the product or as optional accessories. Some of these items are designed to be dealer assembled or installed. Please make sure that benches are stable and any optional fixtures (where applicable) are well secured **BEFORE** using. Benches supplied by Yamaha are designed for seating only. No other uses are recommended.

## PLEASE KEEP THIS MANUAL



For details of products, please contact your nearest Yamaha or the authorized distributor listed below.

Pour plus de détails sur les produits, veuillez-vous adresser à Yamaha ou au distributeur le plus proche de vous figurant dans la liste suivante.

Die Einzelheiten zu Produkten sind bei Ihrer unten aufgeführten Niederlassung und bei Yamaha Vertragshändlern in den jeweiligen Bestimmungsländern erhältlich.

Para detalles sobre productos, contacte su tienda Yamaha más cercana o el distribuidor autorizado que se lista debajo.

## NORTH AMERICA

### CANADA

**Yamaha Canada Music Ltd.**  
135 Milner Avenue, Scarborough, Ontario,  
M1S 3R1, Canada  
Tel: 416-298-1311

### U.S.A.

**Yamaha Corporation of America,  
Keyboard Division**  
6600 Orangethorpe Ave., Buena Park, Calif. 90620,  
U.S.A.  
Tel: 714-522-9011

## CENTRAL & SOUTH AMERICA

### MEXICO

**Yamaha de Mexico S.A. De C.V.,  
Departamento de ventas**  
Javier Rojo Gomez No.1149, Col. Gpe Del  
Moral, Deleg. Iztapalapa, 09300 Mexico, D.F.  
Tel: 686-00-33

### BRAZIL

**Yamaha Musical do Brasil LTDA.**  
Av. Rebouças 2636, São Paulo, Brasil  
Tel: 011-853-1377

### ARGENTINA

**Yamaha Music Argentina S.A.**  
Viamonte 1145 Piso2-B 1053,  
Buenos Aires, Argentina  
Tel: 1-371-7021

### PANAMA AND OTHER LATIN AMERICAN COUNTRIES/ CARIBBEAN COUNTRIES

**Yamaha de Panama S.A.**  
Torre Banco General, Piso 7, Urbanización Marbella,  
Calle 47 y Aquilino de la Guardia,  
Ciudad de Panamá, Panamá  
Tel: 507-269-5311

## EUROPE

### THE UNITED KINGDOM

**Yamaha-Kemble Music (U.K.) Ltd.**  
Sherbourne Drive, Tilbrook, Milton Keynes,  
MK7 8BL, England  
Tel: 01908-366700

### IRELAND

**Danfay Ltd.**  
61D, Sallynoggin Road, Dun Laoghaire, Co. Dublin  
Tel: 01-2859177

### GERMANY/SWITZERLAND

**Yamaha Europa GmbH.**  
Siemensstraße 22-34, 25462 Rellingen,  
F.R. of Germany  
Tel: 04101-3030

### AUSTRIA

**Yamaha Music Austria**  
Schleiergasse 20, A-1100 Wien Austria  
Tel: 01-60203900

### THE NETHERLANDS

**Yamaha Music Nederland**  
Kanaalweg 18G, 3526KL, Utrecht, The Netherlands  
Tel: 030-2828411

### BELGIUM

**Yamaha Music Belgium**  
Keiberg Imperiastraat 8, 1930 Zaventem, Belgium  
Tel: 02-7258220

### FRANCE

**Yamaha Musique France,  
Division Claviers**  
BP 70-77312 Marne-la-Vallée Cedex 2, France  
Tel: 01-64-61-4000

### ITALY

**Yamaha Musica Italia S.P.A.,  
Home Keyboard Division**  
Viale Italia 88, 20020 Lainate (Milano), Italy  
Tel: 02-935-7711

### SPAIN/PORTUGAL

**Yamaha-Hazen Electronica Musical, S.A.**  
Jorge Juan 30, 28001, Madrid, Spain  
Tel: 91-577-7270

### GREECE

**Philippe Nakas S.A.**  
Navarinou Street 13, P.Code 10680, Athens, Greece  
Tel: 01-364-7111

### SWEDEN

**Yamaha Scandinavia AB**  
J. A. Wettergrens Gata 1  
Box 30053  
S-400 43 Göteborg, Sweden  
Tel: 031 89 34 00

### DENMARK

**YS Copenhagen Liaison Office**  
Generatorvej 8B  
DK-2730 Herlev, Denmark  
Tel: 44 92 49 00

### FINLAND

**F-Musiikki Oy**  
Kluuvikatu 6, P.O. Box 260,  
SF-00101 Helsinki, Finland  
Tel: 09 618511

### NORWAY

**Norsk filial av Yamaha Scandinavia AB**  
Grini Næringspark 1  
N-1345 Østerås, Norway  
Tel: 67 16 77 70

### ICELAND

**Skifan HF**  
Skeifan 17 P.O. Box 8120  
IS-128 Reykjavik, Iceland  
Tel: 525 5000

### OTHER EUROPEAN COUNTRIES

**Yamaha Europa GmbH.**  
Siemensstraße 22-34, 25462 Rellingen, F.R. of  
Germany  
Tel: 04101-3030

## AFRICA

**Yamaha Corporation,  
International Marketing Division**  
Nakazawa-cho 10-1, Hamamatsu, Japan 430-8650  
Tel: 053-460-2312

## MIDDLE EAST

### TURKEY/CYPRUS

**Yamaha Europa GmbH.**  
Siemensstraße 22-34, 25462 Rellingen,  
F.R. of Germany  
Tel: 04101-3030

### OTHER COUNTRIES

**Yamaha Music Gulf FZE**  
LB21-128 Jebel Ali Freezone  
P.O.Box 17328, Dubai, U.A.E.  
Tel: 971-4-81-5868

## ASIA

### HONG KONG

**Tom Lee Music Co., Ltd.**  
11/F., Silvercord Tower 1, 30 Canton Road,  
Tsimshatsui, Kowloon, Hong Kong  
Tel: 2737-7688

### INDONESIA

**PT. Yamaha Music Indonesia (Distributor)  
PT. Nusanik**  
Gedung Yamaha Music Center, Jalan Jend. Gatot  
Subroto Kav. 4, Jakarta 12930, Indonesia  
Tel: 21-520-2577

### KOREA

**Cosmos Corporation**  
1461-9, Seocho Dong, Seocho Gu, Seoul, Korea  
Tel: 02-3486-0011

### MALAYSIA

**Yamaha Music Malaysia, Sdn., Bhd.**  
Lot 8, Jalan Perbandaran, 47301 Kelana Jaya,  
Petaling Jaya, Selangor, Malaysia  
Tel: 3-703-0900

### PHILIPPINES

**Yupangco Music Corporation**  
339 Gil J. Puyat Avenue, P.O. Box 885 MCPO,  
Makati, Metro Manila, Philippines  
Tel: 819-7551

### SINGAPORE

**Yamaha Music Asia Pte., Ltd.**  
11 Ubi Road #06-00, Meiban Industrial Building,  
Singapore  
Tel: 65-747-4374

### TAIWAN

**Yamaha KHS Music Co., Ltd.**  
10F, 150, Tun-Hwa Northroad,  
Taipei, Taiwan, R.O.C.  
Tel: 02-2713-8999

### THAILAND

**Siam Music Yamaha Co., Ltd.**  
121/60-61 RS Tower 17th Floor,  
Ratchadaphisek RD., Dindaeng,  
Bangkok 10320, Thailand  
Tel: 02-641-2951

### THE PEOPLE'S REPUBLIC OF CHINA AND OTHER ASIAN COUNTRIES

**Yamaha Corporation,  
International Marketing Division**  
Nakazawa-cho 10-1, Hamamatsu, Japan 430-8650  
Tel: 053-460-2317

## OCEANIA

### AUSTRALIA

**Yamaha Music Australia Pty. Ltd.**  
17-33 Market Street, South Melbourne, Vic. 3205,  
Australia  
Tel: 3-699-2388

### NEW ZEALAND

**Music Houses of N.Z. Ltd.**  
146/148 Captain Springs Road, Te Papapa,  
Auckland, New Zealand  
Tel: 9-634-0099

### COUNTRIES AND TRUST TERRITORIES IN PACIFIC OCEAN

**Yamaha Corporation,  
International Marketing Group**  
Nakazawa-cho 10-1, Hamamatsu, Japan 430-8650  
Tel: 053-460-2312

**HEAD OFFICE** Yamaha Corporation, Electronic Musical Instrument Division  
Nakazawa-cho 10-1, Hamamatsu, Japan 430-8650  
Tel: 053-460-3273

