

YAMAHA

DX7_S

DIGITAL PROGRAMMABLE ALGORITHM SYNTHESIZER

OWNER'S MANUAL

SUPPLEMENTAL MARKING INFORMATION

Yamaha Digital Musical Instrument Products will have either a label similar to the graphic shown below or a molded/stamped facsimile of the graphic on its enclosure. The explanation of these graphics appears on this page. Please observe all cautions indicated.

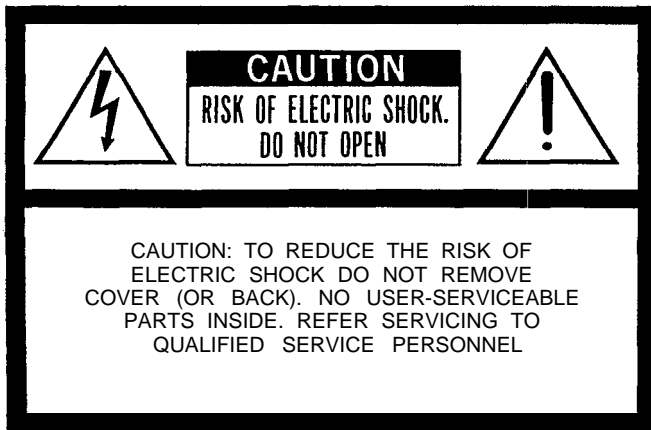

The Exclamation point within an equilateral triangle is intended to alert the user to the presence of important operating and maintenance (servicing) instructions in the literature accompanying the product.

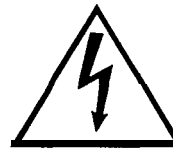

The lightning flash with arrowhead symbol, within an equilateral triangle, is intended to alert the user to the presence of uninsulated "dangerous voltage" within the product's enclosure that may be of sufficient magnitude to constitute a risk of electric shock to persons.

SPECIAL MESSAGE SECTION

ELECTROMAGNETIC INTERFERENCE (RFI): Your Yamaha Digital Musical Instrument Product has been type tested and found to comply with all applicable regulations. However, if it is installed in the immediate proximity of other electronic devices, some form of interference may occur. For additional RFI information see FCC information section located in this manual.

IMPORTANT NOTICE: This product has been tested and approved by independent safety testing laboratories in order that you may be sure that when it is properly installed and used in its normal and customary manner, all foreseeable risks have been eliminated. **DO NOT** modify this unit or commission others to do so unless specifically authorized by Yamaha. Product performance and/or safety standards may be diminished. Claims filed under the expressed warranty may be denied if the unit is/has been modified. Implied warranties may also be affected.

SPECIFICATIONS SUBJECT TO CHANGE: The information contained in this manual is believed to be correct at the time of printing. Yamaha reserves the right to change or modify specifications at any time without notice or obligation to update existing units.

NOTICE: Service charges incurred due to a lack of knowledge relating to how a function or effect works (when the unit is operating as designed), are not covered by the manufacturer's warranty. Please study this manual carefully before requesting service.

STATIC ELECTRICITY CAUTION: Some Yamaha Digital Musical Instrument products have modules that plug into the unit to perform various functions. The contents of a plug-in module can be altered/damaged by static electricity discharges. Static electricity build-ups are more likely to occur during cold winter months (or in areas with very dry climates) when the natural humidity is low. To avoid possible damage to the plug-in module, touch any metal object (a metal desk lamp, a door knob, etc.) before handling the module. If static electricity is a problem in your area, you may want to have your carpet treated with a substance that reduces static electricity build-up. See your local carpet retailer for professional advice that relates to your specific situation.

Model _____

Serial No. _____

Purchase Date _____

Welcome

Welcome to the DX7s, the newest member of the growing family of FM digital synthesizers from Yamaha. Using the industry-standard DX7 as its starting point, the DX7s offers a number of important new features, such as improved sound quality, additional FM features, new performance options, and improved controls.

Since there is so much material available on the DX7 family of synthesizers (and on the theory of FM digital synthesis), this manual will not be an FM tutorial. Instead, it has been designed to be a “users manual” in the truest sense — its goal is to help you make music with your new DX7s as quickly as possible.

If you are already familiar with the operation of the original DX7, this manual will help you make the transition to the DX7s in short order. On the other hand, if this is your first FM digital instrument, this manual will guide you into the operation of your new synthesizer with easy-to-follow, step-by-step instructions and explanations.

After you are comfortable with the operation of your new synthesizer, you may want to explore the fascinating world of FM digital voicing. If so, consult the extensive list of reference works on FM synthesis listed in the bibliography at the back of this manual.

Tips

*The DX7s has been designed for years of trouble-free use. In order to ensure that it remains a healthy member of your family **of** musical instruments, please keep the following tips in mind:*

Installation:

When setting up the DX7s in your home or studio, avoid exposure to direct sunlight or other sources of heat. Environments with excessive dust, cold, dampness, or vibration can also damage your instrument. Even though the DX7s is electronic, you should treat it with the same kind of care you would lavish on any other musical instrument.

Also, since the DX7s is electronic, you should make sure not to set it too close to equipment (such as a television set) that generates electromagnetic fields. Such proximity could cause both malfunctions in the synthesizer's digital circuitry and interference noise in the other unit.

Handling:

The DX7s is sturdy, but it can do without rough handling. Don't subject it to sudden jolts (such as dropping it), as this can damage the internal circuitry. If you plan to travel with it, be sure to use a road case. Also, make sure not to apply excessive force to any of the keys, buttons, or other controls.

Cleaning:

To clean or dust your DX7s, use nothing more than a clean, slightly damp cloth. Using chemical solvents will damage the finish, and using too much water may do considerable damage to the internal circuitry.

AC Power & Other Equipment:

When you are using the DX7s with an amplifier or mixer that has unbalanced outputs, connect both units to the same AC outlet to avoid hum.

If you use a number of electronic instruments in your setup, you may want to consult an electrician, who can make sure that your system does not overtax the available power.

AC Power & Down Time:

Whenever the DX7s will not be used for an extended period of time, it is best to protect it from potential disaster. Electrical storms and other natural or man-made disasters can give rise to power surges, which may damage the digital circuitry of your DX7s — even if the power is turned off. Either unplug your instrument when not in use, or invest in power strips with surge protectors to safeguard all of your electronic equipment.

Service & Your Warranty:

The DX7s contains no user-serviceable parts. Opening it up or tampering with it in any way will void the warranty, and may also lead you to experience some nasty electrical shocks. If you have a problem with your instrument, please take it to an authorized Yamaha service center.

Modifications & Your Warranty:

Unless you are assured to the contrary in writing, you should assume that any modifications made to your DX7s will void the original product warranty. Therefore, you should make sure that you receive a warranty (or some other kind of guarantee) from the person or company that is responsible for the modification.

Contents

1	Section 1: Playing the DX7s
3	Getting Started
6	Setting the ROM Cartridge Banks
8	Exploring the DX7s Performance Library
12	Exploring the DX7s Voice Library
16	The Play Modes
17	Using Controllers with the DX7s
19	Section 2: Creating and Storing New Sounds
21	Creating New Sounds
26	Saving New Sounds
29	Section 3: Using the New Performance Features
31	Performance Edit Buttons
33	Basic Performance Parameters
36	Performance Controllers
38	Micro Tuning
41	Section 4: Using the New Voice Features
43	Voice Edit Buttons
52	Basic Voice Editing Functions
53	New Voice Parameters
55	Voice Controllers
57	Fractional Scaling
59	Section 5: Memory Functions
61	Utility Buttons
64	Memory Layout
66	Memory Storage Types
68	Basic Utility Functions
69	Cartridge Memory Functions
71	Section 6: MIDI Functions
73	MIDI Buttons
75	System Setup
77	MIDI System Exclusives
78	Immediate MIDI Program Change Out
79	Appendices
80	Appendix 1: Supplemental Information
81	Appendix 2: Bibliography
82	MIDI Implementation Chart
83	Blank Data Chart

Section 1
Playing the DX7s

Section 1

Contents

3	Getting Started
3	Making Audio Connections
4	Turning on the DX7s
5	Setting the Volume Slider
6	Setting the ROM Cartridge Banks
6	Inserting the ROM Cartridge
7	Selecting the ROM Banks
8	Exploring the DX7s Performance Library
8	Selecting the Internal Performance Memories
9	The Internal Performance Memories
10	Selecting the Cartridge Performance Memories
11	The Cartridge Performance Memories
12	Exploring the DX7s Voice Library
12	Selecting the Internal Voice Memories
13	The Internal Voice Memories
14	Selecting the Cartridge Voice Memories
15	The Cartridge Voice Memories
16	The Play Modes
16	Voice Mode and Performance Mode
16	Using the 1 ~ 32/33 ~ 64 Button
16	Using the Poly/Mono Button
16	Using the Key Shift Button
17	Using Controllers with the DX7s
17	Pitch Bend Wheel
17	Modulation Wheel
17	After Touch
17	Breath Controller
18	Foot Controllers 1 and 2
18	Footswitches 1 and 2
18	Continuous Sliders 1 and 2

Getting Started

You can begin to enjoy your DX7s immediately, without poring through a lot of complicated electronic theory. All you have to do is take the instrument out of the box and proceed as follows:

Making Audio Connections

There are three different ways to connect the DX7s to sound reinforcement equipment. The one you choose will depend on your situation:

1. If you have a monophonic (single input) amplifier such as a guitar amp, connect the DX's output to the amp's input (using a standard 1/4" cable).

Connecting the DX7s to a single input amplifier.

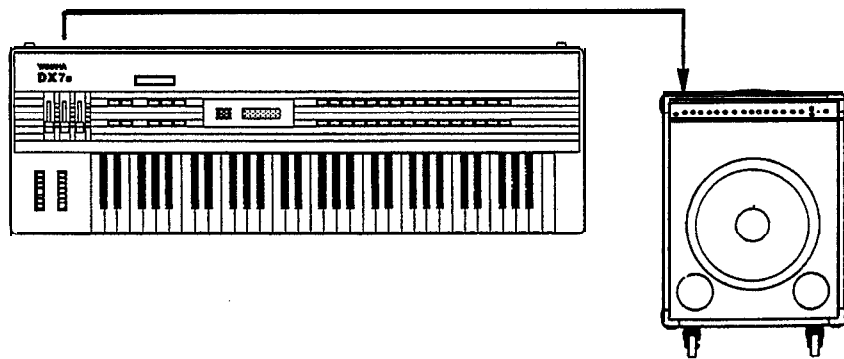

2. If you are using a multi-channel mixer, connect the DX's back-panel audio output to one of your mixer's inputs (using a 1/4" cable).
3. If you are using a set of standard stereo headphones, plug them into the DX's Phones output.

Using stereo headphones with the DX7s.

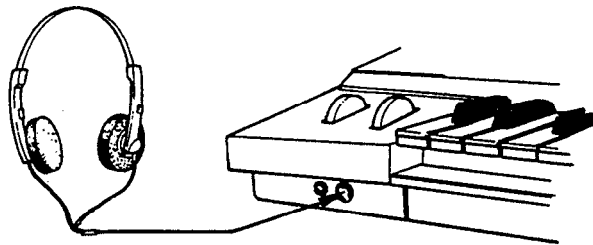

Turning on the DX7s

After you have made the audio connection of your choice, turn the DX7s on by pressing the power switch located on the right side of the back panel. This is the first display you will see on the main panel:

The DX's "welcome" display.

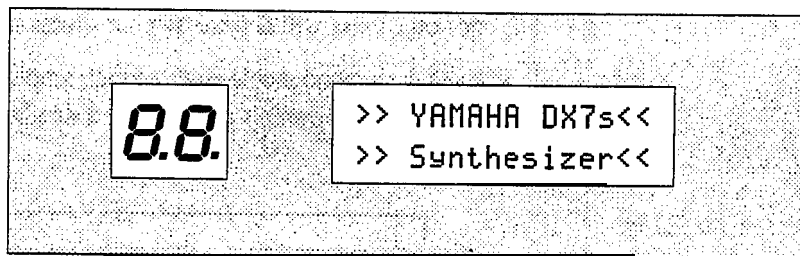

After a few seconds, this display will be replaced by the last Play Mode display selected before the DX7s was turned off:

The DX's next initial display.

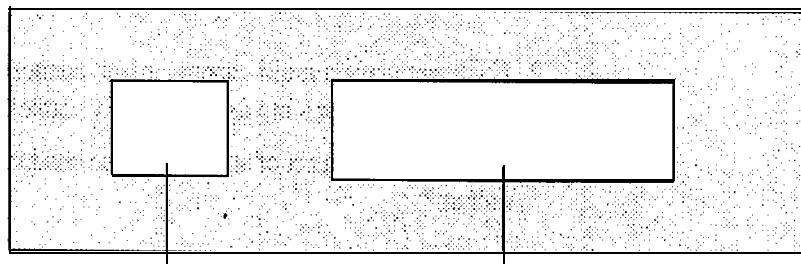

The LED's will now display the voice or performance number that was displayed when the DX was turned off.

The LCD will now show the voice or performance name which corresponds to the number in the LED.

Setting the Volume Slider

Since the volumes of the various voices differ, start with a setting in the middle of the slider's range; adjust later to suit your taste, depending on the voice or voices being played.

Volume Slider

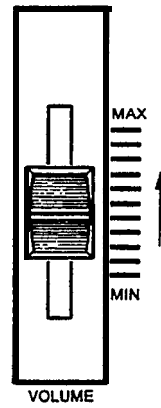

Setting the ROM Cartridge Banks

The ROM Cartridge supplied with your DX7s actually contains several sets of data — called “banks.” These banks can be selected from the front panel. In order to hear all of the Voice and Performance data, you will need to set the Voice/Performance bank to 2. Also, certain voices in the DX7s are created using the new fractional scaling feature. These scalings are stored in bank 3 of the ROM cartridge, so the Fractional Scaling Bank will need to be set to bank 3. Look at the diagram on the next page and make the necessary changes before you begin playing.

Inserting the ROM Cartridge

Before you begin to play your DX7s, insert the supplied ROM cartridge into the cartridge slot:

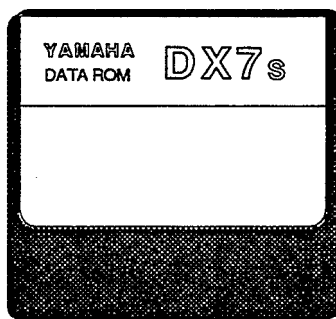

Selecting the ROM Banks

1

VOICE

Press the Voice button.

2

COMPARE
EDIT

Press the Edit button.

3

CARTRIDGE
15 47

Press button 15 until the Set Bank display appears in the LCD.

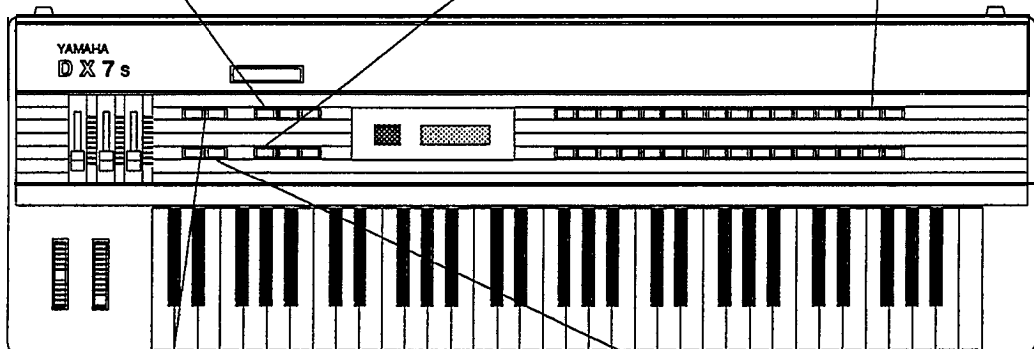

4

POLY/MONO KEY SHIFT
◀ ▶

If necessary, use the cursor keys to move the cursor to the arrow next to "VP" in the Set Bank display.

5

DATA ENTRY
NO YES
-1/OFF +1/ON

If necessary, use the Data Entry buttons or slider to select Bank 2 of the ROM cartridge.

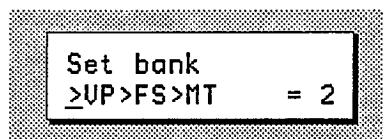

This is the Set Bank LCD display with Bank 2 of the ROM cartridge selected for Voice & Performance data.

6

POLY/MONO KEY SHIFT
◀ ▶

Now use the cursor keys to move the cursor to the arrow next to "FS" in the Set Bank display.

7

DATA ENTRY
NO YES
-1/OFF +1/ON

Use the Data Entry buttons or slider to select Bank 3 of the ROM cartridge.

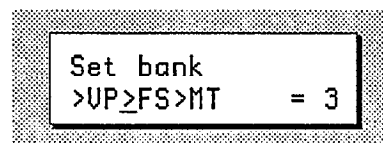

This is the Set Bank LCD display with Bank 3 of the ROM cartridge selected for Fractional Scaling data.

Exploring the DX7s Performance Library

The Performance Mode is a completely new feature for the DX7s. It allows a number of useful performance-oriented features to be stored and recalled instantly. These features will be explained in detail in Sections 2 and 3 of this manual. For now, though, just follow the steps below, and explore the richness of the Performance Mode by playing through all of the new sounds available in the Internal and ROM Cartridge memories.

Selecting the Internal Performance Memories

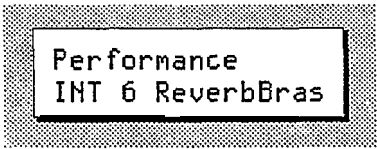
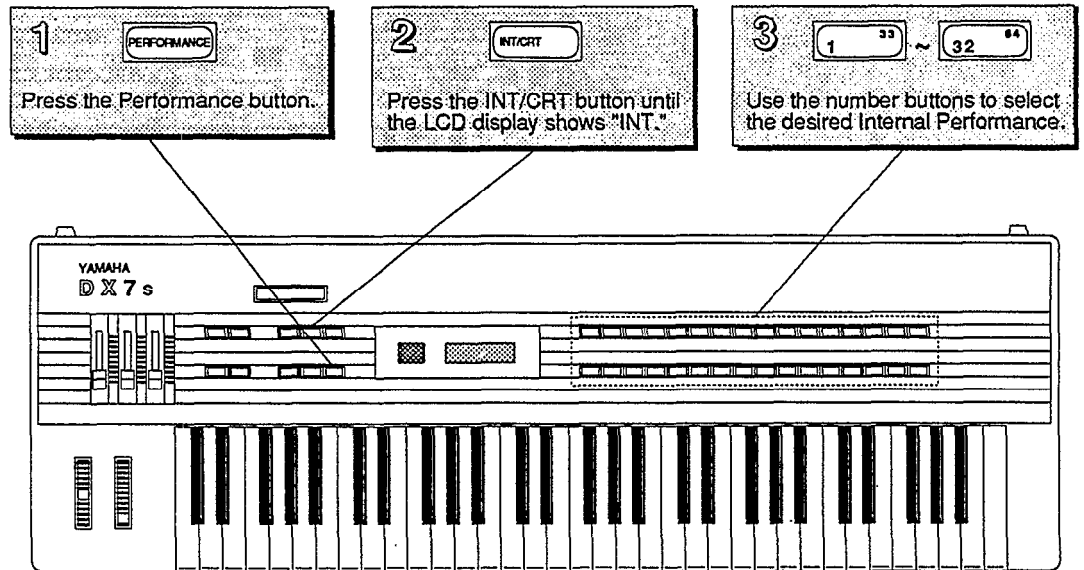



The LCD display will show the number and name of the selected Performance memory.

The Internal Performance Memories

These are the Performance Memories loaded into the DX7s when it is shipped from the factory. Since these memories can be adjusted, your DX's Internal Memory may contain different data. If so, reload the Internal Voice & Performance data from bank 4 of the supplied ROM cartridge (see page 70).

Performance Name	Voice No.	Voice Name
1 SolidStrg	INT 12	HallOrch
2 Strings	INT 13	NewOrchest
3 GrandOrch	INT 15	LiveStrg
4 Cello	INT 16	BowedBass
5 LittleStrg	INT 19	Violins
6 ReverbBras	INT 3	ReverbBras
7 BrightBras	INT 8	SilvaTrmpt
8 MildBrass	INT 10	FrenchHorn
9 W. Leed	INT 20	Bassoon
10 SoftFlute	INT 23	Flute
11 PanPipes	INT 26	PanFloot
12 BlowSax	INT 26	PanFloot
13 BluesHarp	INT 29	Harmonica
14 Harp	INT 30	Harp
15 PianoBrite	INT 32	PianoBrite
16 MildPiano	INT 34	Piano 2
17 Mellow EP	INT 36	RubbaRoad
18 Attack EP	INT 37	HardRoads
19 Crystal EP	INT 38	FullTines
20 DX Clavi 1	INT 39	ClaviStuff
21 DX Clavi 2	INT 40	Clavi
22 Clavicord	INT 41	Clavecin
23 Harpsicord	INT 45	HarpsiWire
24 WireString	INT 46	WireStrg A
25 GreatPipes	INT 57	APuffOrgan2
26 RotaryOrg	INT 50	TapOrgan
27 ConsoleOrg	INT 51	BriteOrgan
28 Magi cOrgan	INT 52	Magi cOrgan
29 SoftOrgan	INT 53	SoftOrgan
30 SchoolOrg	INT 58	Harmoni um1
31 Angel Voi ce	INT 60	Whisper A
32 LadyVox	INT 62	LadyVox

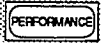
Selecting the Cartridge Performance Memories

-  Press the Performance button.
-  Press the INT/CRT button until the LCD display shows "CRT".
-  Use the number buttons to select the desired Cartridge Performance.

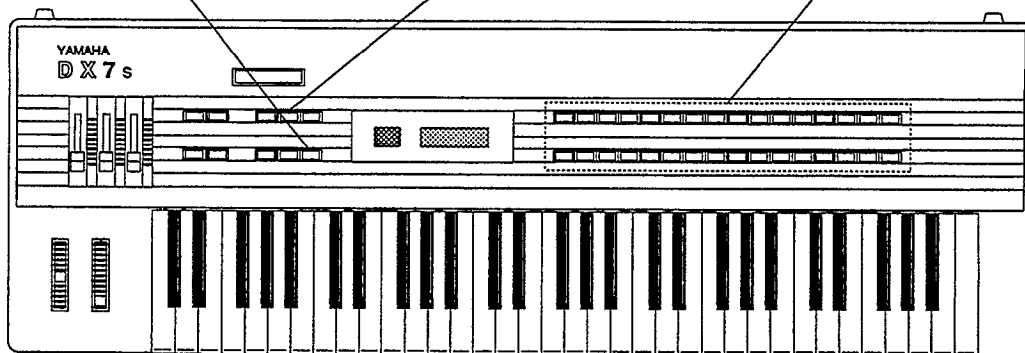

Performance
CRT15 Celeste

The LCD display will show the number and name of the selected Performance memory.

The Cartridge Performance Memories

Bank 4 of the supplied ROM cartridge contains the Voice & Performance Memory loaded into the DXs Internal Memory when it is shipped from the factory. Bank 2 contains an entirely different set of Voice & Performance data.

Performance Name	Voice No.	Voice Name
1 SuperBass	CRT 1	SuperBass
2 WoodBass	CRT 2	StringBass
3 TackBass	CRT 3	SkweekBass
4 FazzBass	CRT 6	Owl Bass
5 Pi ckGui tar	CRT 9	Gui tarBox
6 Fol kGui tar	CRT 10	Pi ckGui tar
7 Cli pGui tar	CRT 13	YesBunk
8 ChoGui tar	CRT 14	12 Strings
9 Hi tPad 1	CRT 17	Mari bumba
10 Hi tPad 2	CRT 19	Nu Marimba
11 Hi tPad 3	CRT 20	StonePhone
12 AfroConga	CRT 25	CongaDrum
13 Woodbl ock	CRT 29	Claves
14 Vi braphone	CRT 21	Vi braPhone
15 Celeste	CRT 22	Celeste
16 GrandBells	CRT 30	Bells
17 Mul ti Drums	CRT 23	Swi ssnare
18 Tomtom	CRT 24	Tom C4
19 Mal letBras	CRT 37	Mal letHorn
20 Clavi Brass	CRT 42	Clavi Brass
21 Ensemble	CRT 36	Ensemble
22 WarmBrass	CRT 46	El ecBrass
23 Syncl aria	CRT 40	Clari Solo
24 Pi anoBells	CRT 49	Pi anoBells
25 St. El mo' s	CRT 50	St. El mo' s
26 Octi Late	CRT 55	Octi Late
27 Ethni cBass	CRT 52	Pl uk
28 Wallop	CRT 60	Wallop
29 Expl osi on	CRT 61	Expl osi on
30 Thunderon	CRT 63	Thunderon
31 Laboratory	CRT 64	Sci ence
32 Motorcycl e	CRT 62	Koi keCycl e

Exploring the DX7s Voice Library

The voices in the DX7s were created using techniques like those used on the original DX7. There are a number of new features available in Voice Mode (most of them extensions of the Function Mode in the original DX7). All of these features will be discussed in detail in Sections 2 and 4 of this manual. For now, though, just follow the steps below: and play through all of the voices available in the Internal and ROM Cartridge memories.

Selecting the Internal Voice Memories

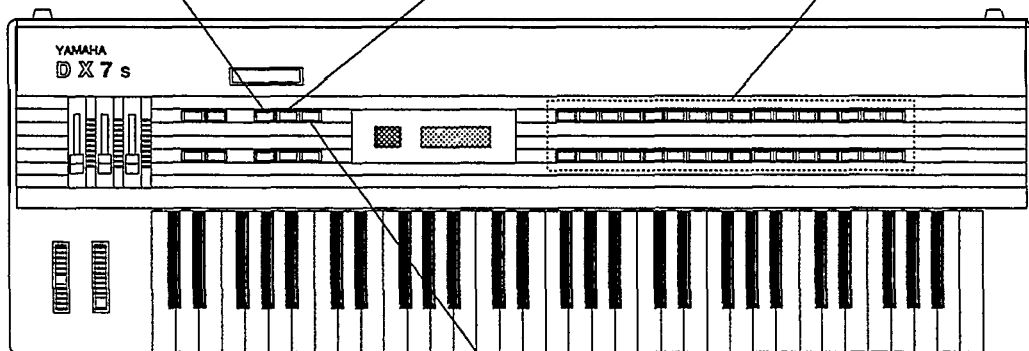
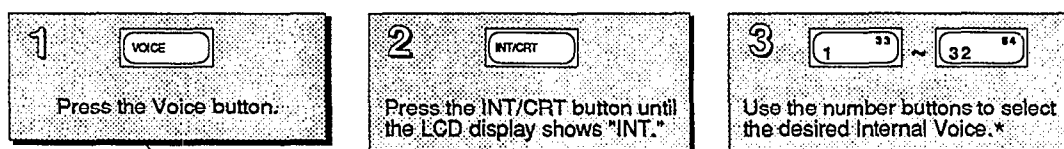

* The 1~32/33~64 light will be off, indicating that voices 1~32 are currently selectable. To select voices 33~64, press the 1~32/33~64 button. The light will go on, indicating that voices 33~64 are currently selectable.

Voice
INT14 Analog-Str

The LCD display will show the number and name of the selected Voice memory.

The Internal Voice Memories



These are the Voice Memories loaded into the DX7s when it is shipped from the factory.

Since these memories can be adjusted, your DX's Internal Memory may contain different data. If so, reload the Internal Voice & Performance data from bank 1 of the supplied ROM cartridge (see page 70).

1	MellowHorn	33	Piano 1
2	SilvaBrass	34	Piano 2
3	ReverbBras	35	KnockRoad
4	Tuba	36	RubbaRoad
5	Trombone	37	HardRoads
6	HardTrumps	38	FullTines
7	Trumpet A	39	Clavi Stuff
8	SilvaTrmpt	40	Clavi
9	BC Trumpet	41	Clavecin
10	FrenchHorn	42	Clavi Pluck
11	Strings	43	Nasal Clav
12	HallOrch	44	Harpsi Box
13	NewOrchest	45	Harpsi Wi re
14	Analog-Str	46	Wi reStrg A
15	LiveStrg	47	Wi reStrg B
16	BowedBass	48	TouchOrgan
17	EleCello A	49	ShOrgan
18	EleCello B	50	TapOrgan
19	Violins	51	BriteOrgan
20	Bassoon	52	Maj i cOrgan
21	Clarinet	53	SoftOrgan
22	Oboe	54	Pi peOrgan
23	Flute	55	PuffOrgan1
24	SongFlute	56	PuffPi pes
25	Spi tFlute	57	PuffOrgan2
26	PanFl oot	58	Harmoni um1
27	Pi ccolo	59	Harmoni um2
28	Sax	60	Whi sper A
29	Harmoni ca	61	Choi r
30	Harp	62	LadyVox
31	EbonyIvory	63	Mal eChoi r
32	PianoBrite	64	Whi sper B

Selecting the Cartridge Voice Memories

As explained on page 6, the DX7s ROM cartridge contains several banks. To hear the cartridge voices, make sure that the Voice/Performance bank is set to bank 2 of the ROM cartridge (see page 7 for instructions on how to change the cartridge banks).

- 1**  Press the Voice button.
- 2**  Press the INT/CRT button until the LCD display shows "CRT."
- 3**  Use the number buttons to select the desired Cartridge Voice.*

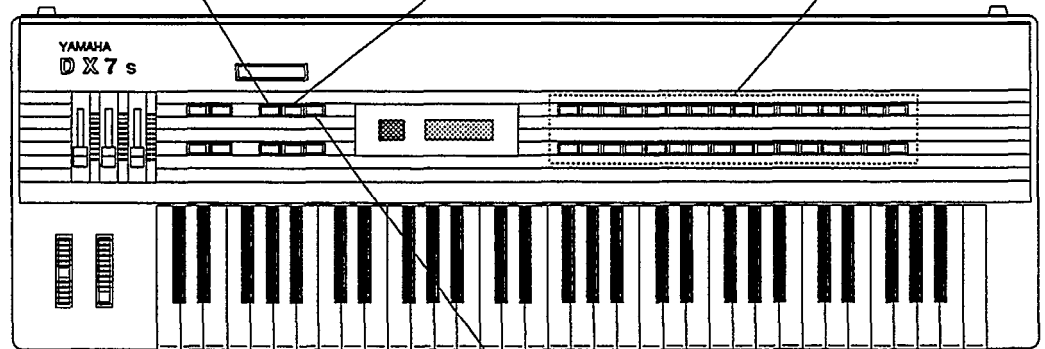

* The 1-32/33-64 light will be off, indicating that voices 1-32 are currently selectable. To select voices 33-64, press the 1-32/33-64 button. The light will go on, indicating that voices 33-64 are currently selectable.

Voice
CRT49 PianoBells

The LCD display will show the number and name of the selected Voice memory.

Bank 4 of the supplied ROM cartridge contains the Voice & Performance Memory loaded into the DX's Internal Memory when it is shipped from the factory. Bank 2 contains an entirely different set of Voice & Performance data.

The Cartridge Voice Memories

1	SuperBass	33	Analog-X
2	StringBass	34	FMilters
3	SkweekBass	35	Phasers
4	SmoothBass	36	Ensemble
5	BopBass	37	MalletHorn
6	OwlBass	38	FM-Growth
7	JazzBass	39	ElectoComb
8	HardBass	40	ClariSolo
9	GuitarBox	41	PitchaPad
10	PickGuitar	42	ClaviBrass
11	FingaPicka	43	WhapSynth
12	LeadaPicka	44	Whasers
13	YesBunk	45	Fifths
14	12 Strings	46	ElecBrass
15	Classipika	47	ElectroBak
16	Shami	48	HarmoSynth
17	Maribumba	49	PianoBells
18	DX Marimba	50	St. Elmo's
19	Nu Marimba	51	MilkyWays
20	StonePhone	52	Pluk
21	VibraPhone	53	TingVoice
22	Celeste	54	Plukatan
23	Swissnare	55	OctiLate
24	Tom C4	56	LateDown
25	CongaDrum	57	Glastine A
26	Tub Bells	58	BellWahh
27	Gong	59	RubberGong
28	Timpani	60	Wallop
29	Claves	61	Explosion
30	Bells	62	KoikeCycle
31	StellCans	63	Thunderon
32	Handrum	64	Science

The Play Modes

Now that you have an idea of some of the sound possibilities of the DX7s, it is time to take a closer look at how the various Play Modes operate. Read on:

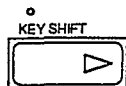
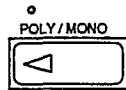
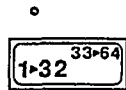
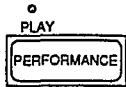
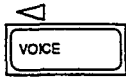

Voice Mode and Performance Mode

The DX7s has two different play modes: Voice Mode and Performance Mode. As you have just seen, the Voice Mode is where you recall the 64 Internal Voice memories and the 64 Cartridge Voice memories. Press Voice and use the 1 ~ 32/33 ~ 64 button and the program number buttons to select specific voices. There are 32 Performance memories that you can access by pressing Performance and the program number buttons. When you are in Performance Mode, the light over the Performance button will be lit. When you choose a Performance, features such as Micro Tune and Key Shift are added to the voice.

Using the 1 ~ 32/33 ~ 64 Button

The light above the 1 ~ 32/33 ~ 64 button tells you which set of voices can be selected. If the light is off, voices 1 ~ 32 can be selected using the number buttons; if the light is lit, voices 33 ~ 64 can be selected using the number buttons.

Using the Poly/Mono Button

The light above the Poly/Mono tells you which Key Mode is currently active in Play Mode. If the light is off, the Key Mode is polyphonic; if the light is lit, the Key Mode is monophonic. Key Modes will be explained further in Section 4.

Using the Key Shift Button

The Key Shift button determines whether the key shift programmed in Performance Mode will be applied when you recall the Performance. If the light above Key Shift is off, no key shift will be applied; if the light is lit, the preprogrammed key shift is applied.

Using Controllers with the DX7s

The DX7s is designed to operate with many controllers, each of which can be set to perform one of a number of different effects. The settings for these controllers can be different for each Voice memory or Performance memory. To begin your exploration of the expanded musical possibilities available with controllers on the DX7s, try the examples listed below. Many of you may already be familiar with the operation of these controller's; for those who are not, each section below begins with instructions on how to locate or attach the controller in question.

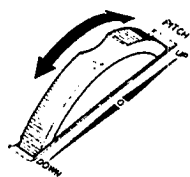

Pitch Bend Wheel

The Pitch Bend Wheel is located to the far left of the keyboard. To get an idea of some of the effects possible with the Pitch Bend Wheel, use it with Internal Performance #1 or Internal Performance #31. Move the Wheel both quickly and slowly as you play.

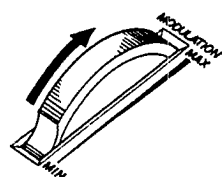

Modulation Wheel

The Modulation Wheel is located to the near left of the keyboard (to the right of the Pitch Bend Wheel). For a taste of the possibilities of the Modulation Wheel, try it with Internal Performance #6 or Internal Performance #13.

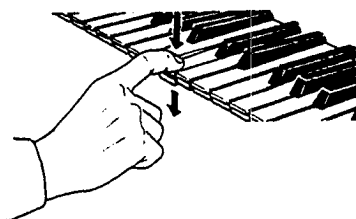

After Touch

After Touch is a keyboard feature that gives you extra control over a voice. It is engaged by pushing down on the keys after they have already been depressed. To try some of the effects available with After Touch, call up Cartridge Performance #4 or Cartridge Performance #5 (from bank 2 of the ROM). After you have played a group of keys, press them down into the key bed and listen to the result.

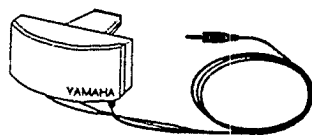

Breath Controller

The Breath Controller plugs into the mini-jack to the left of the Phones plug on the front of the DX7s. It allows you a great deal of expressive control over the shape of the sounds you play on the keyboard. Try using the Breath Controller in conjunction with Internal Voice #9. With this voice, you will notice that playing on the keyboard by itself produces no sound. In order to hear the voices, you must hold down keys and blow into the Breath Controller.

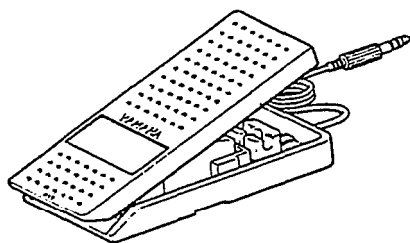

Foot Controllers 1 and 2

The Foot Controllers plug into the two Foot Controller plugs on the back panel of the DX7s. They can give you continuous control over a number of aspects of the sounds. Try using Foot Controller 1 with Cartridge Performance #25 or Internal Performance #12 (from bank 2 of the ROM). Foot Controller 2 is most often used as a volume pedal, but other effects are possible.

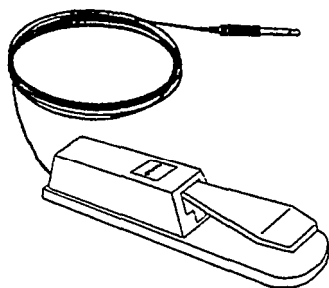

Footswitches 1 and 2

The Footswitches plug into the two Footswitch plugs on the back panel of the DX7s. Footswitch 1 acts much like a sustain pedal on a piano. Try it with Internal Performance #19 or Cartridge Performance #5 to get an idea of the different effects that are possible. Footswitch 2 can be used to engage a number of effects, including that of the soft pedal on a piano. Try it in conjunction with Internal Performance #4 or Cartridge Performance #8 (from bank 2 of the ROM).

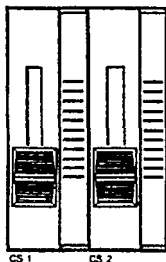

Continuous Sliders 1 and 2

The Continuous Sliders are located to the right of the Volume Slider on the left side of the DX's front panel. They can be programmed to give you control over many aspects of the timbre of the sounds, and can even be used to alter parameters of a voice in real time. Try using Continuous Slider 1 with Internal Performance #8 or Cartridge Performance #3. Then listen to the effect that Continuous Slider 2 has on Internal Performance #3 or Cartridge Performance #24.

Creating and Storing New Sounds

Section 2 Contents

- 21 Creating New Sounds**
- 21 Editing and Edit Mode
- 22 Entering Edit Mode
- 23 Editing Performance and Voice Data
- 23 Using the Cursor Buttons and the Data Entry Buttons/Slider
- 23 Edit/Compare
- 24 Edit Button Quick Reference Guide

- 26 Saving New Sounds**
- 26 Memory Protection
- 26 Turning Memory Protect Off
- 26 Voice and Performance Memory
- 27 Storing Performance Data to Internal or Cartridge Memory
- 27 Storing Voice Data to Internal or Cartridge Memory

Creating New Sounds

The Voices and Performance setups in the DX7s are stored as digital information in a computer-like memory. And, like computer memory, the memory of the DX7s can be altered for different uses. In other words, voices do not exist as unchangeable presets (as they do in electronic organs), but rather as streams of data. This data can be changed (edited) to create new Voice and Performance setups. To find out how this works, read on.

Editing and Edit Mode

Editing is the process of changing various settings of a Voice or Performance memory. In the DX7s, this is accomplished in Edit Mode. Usually, you will use Edit Mode to create a new Voice or Performance setup, but you can also use it to find out the parameter values for the factory preset Voices and Performance setups.

Most of the buttons on the DX's front panel have multiple functions. You can see this by looking at the way the buttons are labeled on the front panel. For example, the +1 button also functions as YES and ON. In most cases, the buttons will have different functions in different operating modes.

The 32 number buttons are no exception: In the Play Modes, they are used to call up various Voice and Performance memories; but, in the Edit Modes, they are used to access the various parameter values that make up a sound.

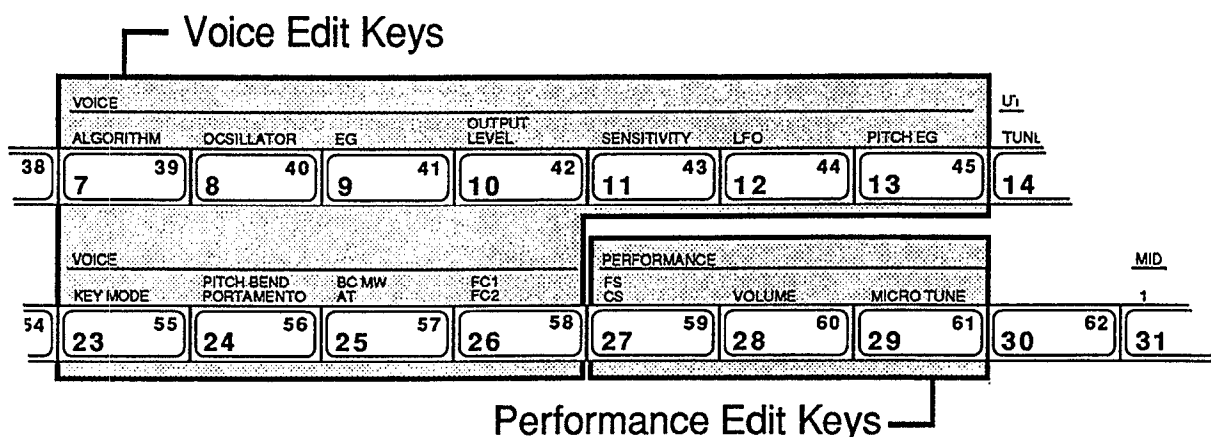

Normally, when you enter the voice play mode (by pressing the voice button), the performance parameters will automatically be initialized. If you then go into the performance play mode (by pressing the performance button) the LCD display will show you this by displaying "INIT PERF".



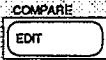

Notice that the number in the LED changes to show which memory number you began editing. When you switch between a voice parameter and a performance parameter, the LED will show the corresponding number.

Entering Edit Mode

In the Edit Mode, you can edit both Voice and Performance parameters.



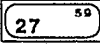

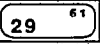
1   Press the Edit button.

PERFORMANCE

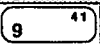
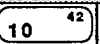
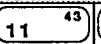
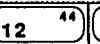

FS CS	VOLUME	MICROTUNE
 27 ⁵⁹	 28 ⁶⁰	 29 ⁶¹

Use number buttons 27 ~ 29 to access the various Performance parameters.

VOICE

ALGORITHM	OSCILLATOR	EG	OUTPUT LEVEL	SENSITIVITY	LFO	PITCH EG
 7 ³⁹	 8 ⁴⁰	 9 ⁴¹	 10 ⁴²	 11 ⁴³	 12 ⁴⁴	 13 ⁴⁵

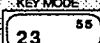
VOICE

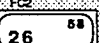
KEY MODE	PITCH BEND PORTAMENTO	SC MW AT	FC1 FC2
 23 ⁵⁵	 24 ⁵⁶	 25 ⁵⁷	 26 ⁵⁸

Use number buttons 7 ~ 13 and 23 ~ 26 to access the various Voice parameters.

 **PERFORMANCE**

or

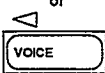
 **VOICE**

Press the Performance or Voice button again to return to Play Mode.

In the above procedure, the Edit Mode is entered after the Edit button is pressed in step #1. At that time, you can push any or all of the buttons indicated as many times as necessary to make the desired edits.

There is a distinction between editing Performance parameters and editing Voice parameters that you may want to be aware of. In certain cases, (such as using compare) you may not retain all your edits. It is a good idea to edit Performance and Voice data separately (more on this later).

Editing Performance and Voice Data

After entering one of the Edit Modes, use the number buttons to access the parameter whose value you wish to change. Each number button calls up a variety of parameters, often through the use of multiple LCD screen displays. A complete set of these screen displays will be given at the beginning of Section 3 (for Performance parameters) and Section 4 (for Voice parameters). In most cases, each LCD display gives you access to a number of parameters.

Using the Cursor Buttons and the Data Entry Buttons/Slider

In some cases, you will need to use these buttons to position the LCD cursor next to the parameter you wish to edit.

The cursor buttons and the data entry slider/buttons.

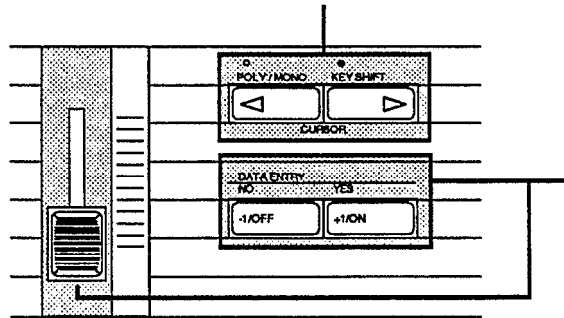

Once you have selected the parameter to edit (using the cursor buttons), use the data entry slider or the +1/-1 buttons to change the value of the selected parameter. The new values will appear in the bottom row of the LCD, and you will hear the effect of these new values when you play the keyboard.

Edit/Compare

Once you have started to edit a voice, you can compare your new sound to the original by pressing the Edit/Compare button:

The Edit/Compare LED display.

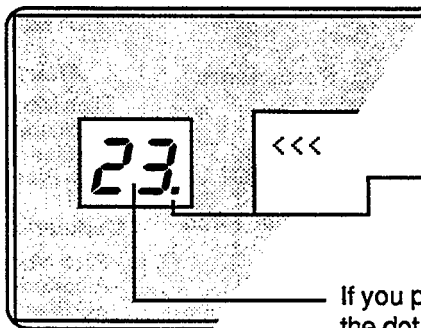

Once you have changed a value in Edit mode, this dot will light, indicating that you are now listening to an edited voice. The LCD will display edited values.

If you press the Edit/Compare button after editing a voice, the dot will disappear and the LED number will flash, indicating that you can now play and listen to the original, unedited voice. LCD values will be those of the original, unedited voice.

You may use the compare feature for Voice data, Performance data, or Micro Tune data. It is best not to use compare when you are simultaneously editing more than one type of data. For example, if you are editing Voice data, and then start editing Performance data, using compare may cause Voice data to revert to the original.

Edit Button Quick Reference Guide

Voice parameters are discussed in more detail in Section 4.

ALGORITHM 7 ³⁹	OSCILLATOR 8 ⁴⁰	EG 9 ⁴¹	OUTPUT LEVEL 10 ⁴²
Algorithm Feedback Level Oscillator Sync Transpose Voice name	Oscillator Mode Coarse Frequency Fine Frequency Oscillator Detune	Rate Scaling Rates 1~4 Levels 1~4	Scaling Mode <i>Normal Scaling</i> Output Level Break Point Left Scaling Curve Right Scaling Curve Left Scaling Depth Right Scaling Depth
SENSITIVITY 11 ⁴³	LFO 12 ⁴⁴	PITCH EG 13 ⁴⁵	 <i>Fractional Scaling</i> Offset Scaling Level for Key Range
Key velocity Amplitude Mod Pitch Mod	Waveshape Speed Delay before LFO Mode Pitch Mod Depth Amp Mod Depth LFO Sync	Octave Range Velocity Rate Scaling Rates 1~4 Levels 1~4	

Voice parameters are discussed in more detail in Section 4.

KEY MODE 23 ⁵⁵	PITCH BEND PORTAMENTO 24 ⁵⁶	BC MW AT 25 ⁵⁷	FC1 FC2 26 ⁵⁸
Key Mode Unison Detune	Pitch Bend Mode Range Step Range Portamento Mode Time Step Range Random Pitch Depth	Breath Control Pitch Mod Amplitude Mod EG Bias Pitch Bias Aftertouch Pitch Mod Amplitude Mod EG Bias Pitch Bias Modulation Wheel Pitch Mod Amplitude Mod EG Bias	Foot Control 1 Control Slider 1 Pitch Mod Amplitude Mod EG Bias Volume Foot Control 2 Pitch Mod Amplitude Mod EG Bias Volume MIDI IN Control Pitch Mod Amplitude Mod EG Bias Volume

Performance parameters are discussed in more detail in Section 3.

FS CS <div style="border: 1px solid black; padding: 2px; display: inline-block;">27 59</div>	VOLUME <div style="border: 1px solid black; padding: 2px; display: inline-block;">28 60</div>	MICRO TUNE <div style="border: 1px solid black; padding: 2px; display: inline-block;">29 61</div>
Foot Switch Select Soft Amount CS 1 Select CS 2 Select	Total Volume EG Forced Damping	Micro Tuning Select Key Shift Performance Name Voice Number

Utility parameters are discussed in more detail in Section 5.

TUNE <div style="border: 1px solid black; padding: 2px; display: inline-block;">14 46</div>	CARTRIDGE <div style="border: 1px solid black; padding: 2px; display: inline-block;">15 47</div>	
Master Tuning Memory Protect Internal Cartridge Micro Tuning Coarse Frequency Fine Frequency	Recall Edit Voice Edit Performance Edit Micro Tuning Edit Initialize Voice Performance	Load from Cartridge Save to Cartridge Fractional SC. Micro Tuning Voice and Performance Bank Set Format

MIDI parameters are discussed in more detail in Section 6.

MIDI 1 <div style="border: 1px solid black; padding: 2px; display: inline-block;">31 63</div>	MIDI 2 <div style="border: 1px solid black; padding: 2px; display: inline-block;">32 63</div>	
Channel Messages Transmit Channel Receive Channel Omni Mode Local Mode	MIDI Note Selection Program Change Transmit Mode Aftertouch	System Exclusive Device number Receive block Transmit block
Control Number MIDI In Controller Continuous Slider 1 Continuous Slider 2	Program Change Program Number to Send	MIDI OUT System Performance (edit) 32 Performances Voice (edit) 32 Voices Micro Tuning (edit) Micro Tuning (user) Micro Tuning (cartridge)

Saving New Sounds

Once you have altered a particular Voice or Performance memory to your liking, you will want to save your new data in one of the DX's memory locations. Voice memories and Performance setups can be saved either to the Internal Memory or to a RAM Cartridge Memory. To do so, proceed as follows:

Memory Protection

Each time the DX7s is turned on, it automatically powers up with both the Internal and the Cartridge Memory Protect feature turned on. Before you can save data, you must turn off this automatic memory protection.

Turning Memory Protect Off

1 Press the Edit button.

2
Press the Tune button (#14) to access the internal Protect display.

3 Press the -1/NO button to turn the INT Memory Protect off.





4
Press the Tune button (#14) once more to access the Cartridge Protect display.

5 Press the -1/NO button to turn the CRT Memory Protect off.

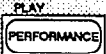

Voice and Performance Memory

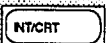
If you have edited both Performance data and Voice data, be sure to save the Voice data to a Voice memory and a Performance data to a Performance memory. Both will need to be saved independently.

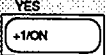
Storing Performance Data to Internal or Cartridge Memory

1		Press the Performance button.
2		Press and hold the Store button.
3		Press the INT/CRT button to select the storage area for your edited Performance data. NOTE: If you wish to save the Performance data to a RAM cartridge, make sure that a properly formatted cartridge (DX7-2) is installed in the cartridge port.
4		While holding the Store button, use the number buttons to select the memory location for your edited Performance data. The LCD will echo your choice.
5		While still holding the Store button, press the +1/YES button.

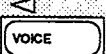
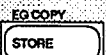
Storing Voice Data to Internal or Cartridge Memory

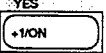
1		Press the Voice button.
2		Press and hold the Store button.
3		Press the INT/CRT button to select the storage area for your edited Voice data. NOTE: If you wish to save the Voice data to a RAM cartridge, make sure that a properly formatted cartridge (DX7-2) is installed in the cartridge port.
4		While holding the Store button, use the number buttons to select the memory location for your edited Voice data. The LCD will echo your choice.
5		While still holding the Store button, press the +1/YES button.

Section 3

**Using the New
Performance Features**

Section 3 Contents

- 31 Performance Edit Buttons**
 - 31 Button 27 LCD Displays
 - 31 Button 28 LCD Displays
 - 32 Button 29 LCD Displays

- 33 Basic Performance Parameters**
 - 33 Total Volume
 - 33 Key Shift
 - 34 EG Forced Damp
 - 35 Performance Name
 - 35 Voice Number

- 36 Performance Controllers**
 - 36 Sustain Footswitch (FS 1)
 - 36 Footswitch 2 (FS 2)
 - 37 Continuous Sliders
 - 37 FM Parameters Assignable to CS1 and CS2

- 38 Micro Tuning**
 - 38 Selecting a Micro Tuning
 - 38 The Micro Tuning Presets
 - 38 Micro Tuning Editing and Storage

Performance Edit Buttons

All of the Performance Mode parameters are adjusted via the LCD displays called up using buttons 27 ~ 29. All of these buttons call up multiple LCD displays. The charts below show all of the displays called up by each button, and provide a complete list of parameters and value ranges. In some cases, the first LCD display in a chart may not be the first one you see. You may need to cycle through the displays (by pressing the button repeatedly) until you reach the desired LCD display.

Buttons 27 LCD Displays

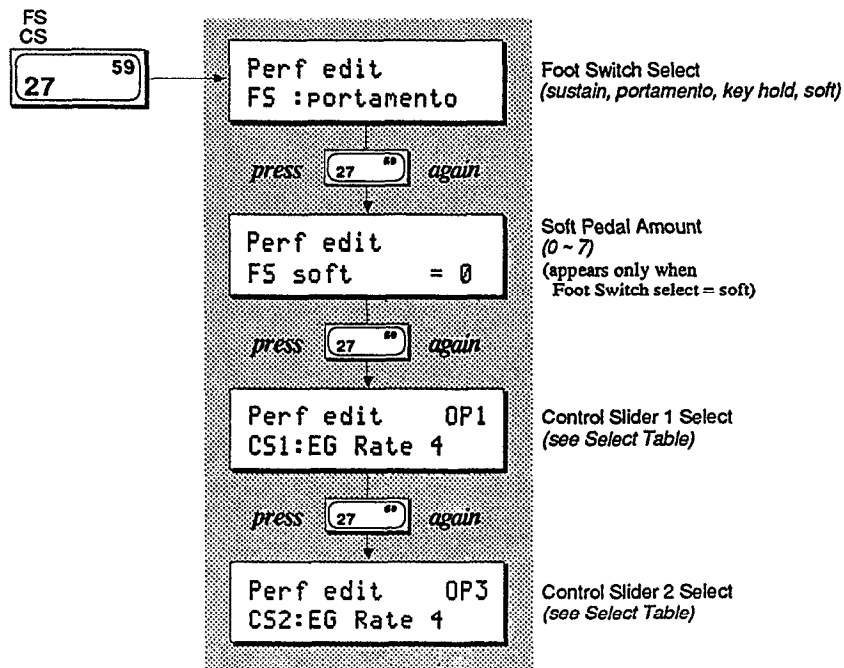

Button 28 LCD Displays

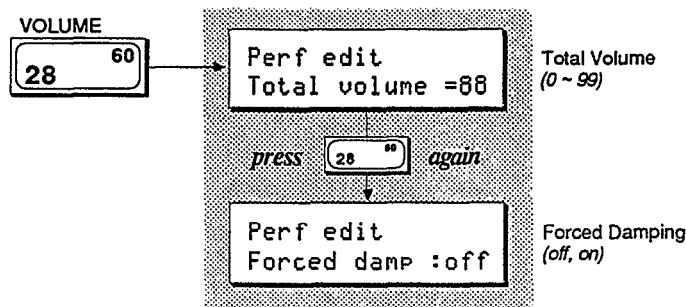

Button 29 LCD Displays

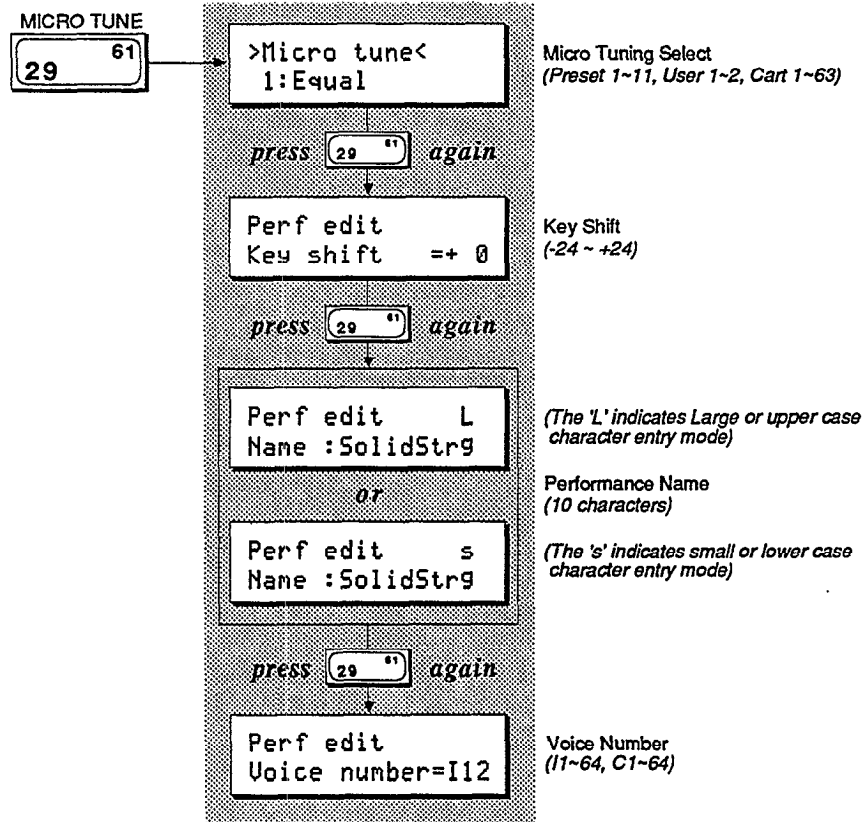

Basic Performance Parameters

Accessed using buttons 28 and 29, these parameters determine the basic voice relationships in Performance Mode.

Total Volume

This parameter allows you to set an overall volume for each Performance memory. If you desire, you can use this setting to balance the levels of your Performance memories, so that constant Volume Slider or mixer adjustments are not necessary.

Key Shift

This parameter allows you to adjust the transposition of the Performance. The Performance can be adjusted up or down as much as two octaves (in halfsteps). The original transposition of the voice is retained as part of the Voice memory, and the Key Shift value is added to or subtracted from that Voice setting when you are in Performance Mode. The light over the Key Shift button must be lit in order to hear changes made to this parameter.

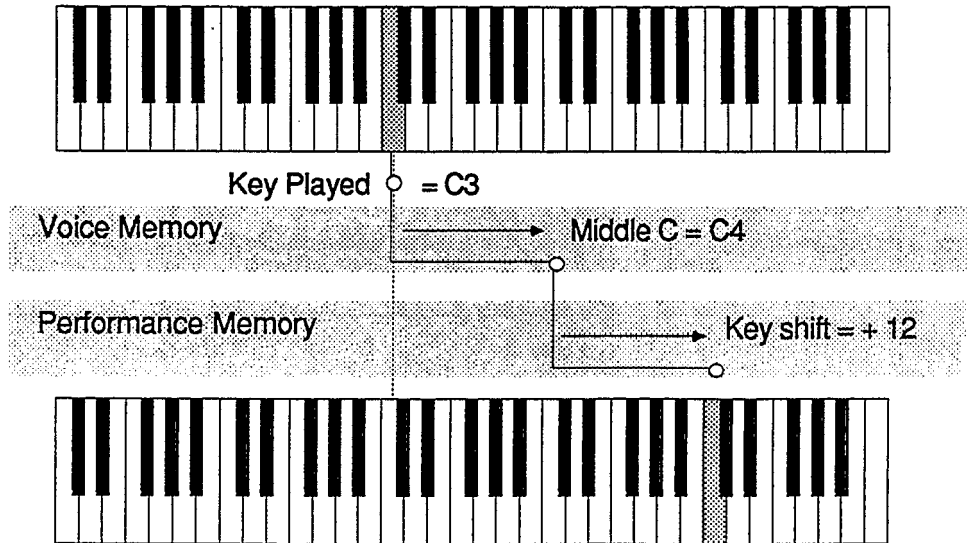

EG Forced Damp

Even though the DX7s is a 16-voice synthesizer, these voices can be used up quickly when you use a Sustain Footswitch pedal. When you do exceed the DX's note capacity, the first notes played will stop sounding to make way for the new notes being played.

Under normal operating conditions, the DX7s considers these new notes to be continuations of the first notes; therefore, the initial portions of the attack envelope will not be retriggered:

Under normal conditions, the DX's envelope acts this way.

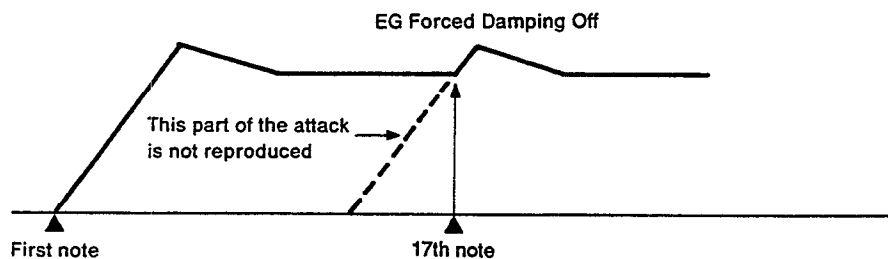

If you wish to avoid this effect, turn the Forced Damping function on. It will force the envelope to retrigger for each new note played:



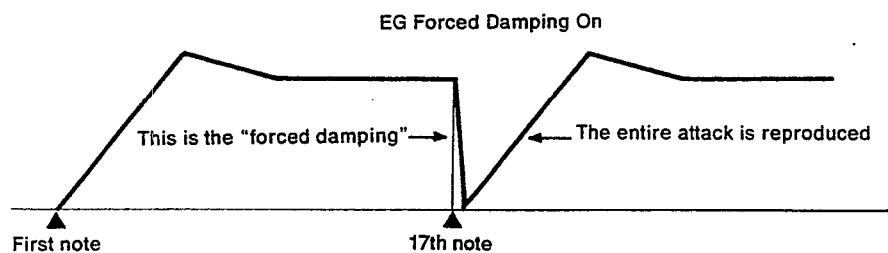

Using the EG Forced Damping parameter, the envelope is forced to retrigger itself for each new note played.



Since you have a total of ten characters to define your Performance Memory, make sure that your Performance Name conveys the basic approach of the specific Performance Memory.

Performance Name

You can enter a Performance Name of up to ten characters. To do so, follow the instructions below.

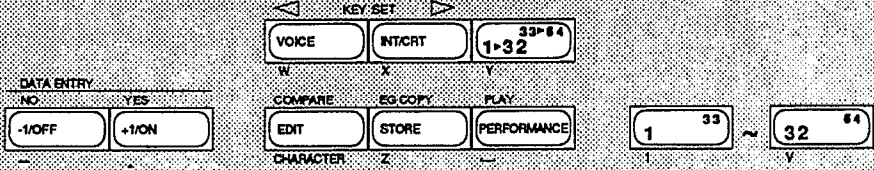
- 1  Press the Performance button.
- 2  Press the Edit button.
- 3  Press the Micro Tune button (#29) to access the Performance Name display.
- 4  Press and hold the Edit/Character button.
- 5 

While holding the Edit/Character button down, type in the desired Performance name using the alphanumeric characters under the buttons.

Using the left and right cursor buttons while holding the Edit/Character button lets you place the cursor over a specific character position. This allows you to easily edit any character within a name.

Using the Data Entry buttons while NOT holding the Edit/Character button lets you switch between Large or small characters. The +1 button selects the Large character mode, the -1 button selects the small character mode.

In addition to letting you enter small alpha characters, the small character input mode lets you enter the following symbols as well.

Large mode	1	2	3	4	5	6	7	8	9	0	-	.
small mode	!	@	#	\$	%	^	&	*	()	+	,

Voice Number

Each time you select a Performance, one of the 64 Internal or 64 Cartridge Voices is also selected. You determine which voice will be selected via this display.

Performance Controllers

The DX7s features a greatly expanded set of controller options. The settings for Footswitches 1 and 2 and Continuous Sliders 1 and 2 are adjusted in Performance Edit Mode, using button 27. (The other controller settings are accessed in voice parameters.)

Sustain Footswitch (FS 1)

Footswitch 1 is set to operate as a sustain pedal.

Footswitch 2 (FS 2)

Footswitch 2 is a multipurpose pedal with four selectable functions: Sustain, Portamento, Key Hold, or Soft.

If Sustain is selected, FS 2 operates as a sustain pedal (just like FS 1).

If Portamento is selected, voice portamento effects will operate only when the pedal is depressed.

If Key Hold is selected, only notes that are being held when the pedal is engaged will sustain. This effect is similar to a piano's sostenuto pedal.

If Soft is engaged, the pedal will soften the timbre and volume of the sound. You can edit the range of the soft pedal by pressing button 27 again. The range is 1 ~ 7.

The Continuous Sliders provide a new avenue for exploration of real-time timbral control.

Continuous Sliders

The two Continuous Sliders give you access to real-time control of FM voice parameters. There are a total of 103 different possibilities:

FM Parameters Assignable to CS 1 and CS2

DATA ENTRY slider

highest position



- OP 6 Total level
- ? OP 1
- OP 6 AMP. MOD. SENS
- ? OP 1
- OP 6 Key velocity
- ? OP 1
- OP 6 EG Level 4 (L4)
- ? OP 1
- OP 6 EG Level 3 (L3)
- ? OP 1
- OP 6 EG Level 2 (L2)
- ? OP 1
- OP 6 EG Level 1 (L1)
- ? OP 1
- OP 6 EG Rate 4 (R4)
- ? OP 1
- OP 6 EG Rate 3 (R3)
- ? OP 1
- OP 6 EG Rate 2 (R2)
- ? OP 1

- OP 6 EG Rate 1 (R1)
- ? OP 1
- OP 6 OSC. detune
- ? OP 1
- OP 6 Frequency fine
- ? OP 1
- OP 6 Frequency coarse
- ? OP 1
- Portamento time
- Pitch EG Level 4
- ? Level 1
- Pitch EG Rate 4
- ? Rate 1
- LFO AMD
- PMD
- PMS
- Delay
- Speed
- Wave
- Feedback level
- Algorithm
- Total volume
- No effect



lowest position

Micro Tuning

The new DX7s contains eleven preset Intonations, which provides you with a good introduction to alternate intonation schemes.

Micro Tuning is another new feature for the DX7s. It offers the possibility of performing music using tuning and intonation systems other than Equal Temperament (which is the current standard tuning for both pianos and synthesizers). Micro Tuning data is accessed using button 29. New Micro Tunings are created in Micro Tuning Edit Mode, which is accessed using button 14 in conjunction with button 29.

Selecting a Micro Tuning

The DX7s is equipped with eleven preset Micro Tunings as part of its permanent memory.

The Micro Tuning Presets

1	Equal	Equal Temperament
2	Pure (major)	Pure (Major)
3	Pure (minor)	Pure (Minor)
4	Mean tone	Mean tone
5	Pythagorean	Pythagorean
6	Werckmeister	Werckmeister
7	Kirnberger	Kirnberger
8	Vallotti, yong	Vallotti & Young
9	1/4 Shift eql	1/4 Shifted equal
10	1/4 Tone	1/4 Tone
11	1/8 Tone	1/8 Tone

In presets 2 ~ 5, the tuning can be adjusted according to the key of the music being played.



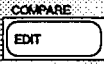
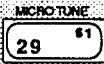
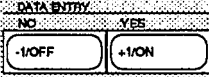
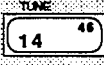

Micro Tuning Editing and Storage

If you are interested in alternate tunings and intonations, you may want to create your own sets of Micro Tuning data. The DX7s provides two memory locations for this purpose: User 1 and User 2. These two sets of data are stored as part of the Internal Memory, and will be stored along with all other Internal data when the Internal Voice & Performance Memory is saved to another storage medium (such as a RAM cartridge). In addition, up to 63 Micro Tunings can be saved to a RAM cartridge that has been properly formatted for that purpose.

*Entering the
Micro Tuning
Edit Mode*

1		Press the Performance button.
2		Press the Edit button.
3		Press the Micro Tune button (#29) to access the Micro Tuning LCD display.
4		Use the +1/-1 buttons to select the Micro Tuning Preset you wish to use as your starting point.
5		Press the Tune button (#14) to select the Micro Tuning edit LCD display.

*Editing
Micro Tuning
Data*

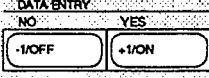
1	Press and hold the key of the note you wish to edit.	
	 or 	While holding the key, press either the Voice button or the INT/CRT button. The note you have chosen will be displayed on the top right of the LCD.
	OR	
1		Use the Voice and INT/CRT buttons as left and right cursors to change the LCD display until the note you wish to edit is displayed in the top right of the LCD.
2		Use the cursor buttons to select the Coarse or Fine tuning parameter.
3		Use the data entry slider or the +1/-1 buttons to adjust Coarse or Fine tuning parameters to the desired values.

*Storing
Micro Tuning
Data*

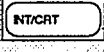
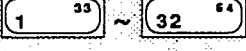
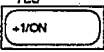
1		Press and hold the Store button.
2		Use the INT/CRT button to select the Internal or Cartridge memory area. The LCD will echo your choice. NOTE: If you wish to save the Micro Tuning data to a RAM cartridge, make sure that a properly formatted Cartridge (MTT-Y) is inserted in the cartridge port.
3		Use the number buttons (and the 1~32/33~64 button if necessary) to choose the desired location for your Micro Tuning data: 1~2 in Internal memory or 1~63 in Cartridge memory.
4		While still holding the Store button, press the +1/YES button.

Section 4
**Using the New
Voice Features**

Section 4 Contents

43	Voice Edit Buttons
43	Button 7 LCD Display
44	Button 8 LCD Display
44	Button 9 LCD Display
45	Button 10 LCD Displays
46	Button 11 LCD Display
47	Button 12 LCD Display
48	Button 13 LCD Display
48	Button 23 LCD Displays
49	Button 24 LCD Displays
50	Button 25 LCD Displays
51	Button 26 LCD Displays
52	Basic Voice Editing Functions
52	Operator Select
52	Operator On/Off
52	EG Copy
53	New Voice Parameters
53	Pitch Envelope
53	LFO
54	Key Modes
55	Voice Controllers
55	Function Data and Voice Effect Data
55	Pitch Bend Modes
55	Foot Controller 1 and 2
56	Pitch Bias
57	Fractional Scaling
57	Fractional Scaling and Level Scaling
57	Fractional Scaling Editing and Storage

Voice Edit Buttons

All of the Voice Mode parameters are adjusted via the LCD displays called up using buttons 7 - 13 and 23 - 26. Many of these buttons call up multiple LCD displays. The charts below show all of the displays called up by each button, and provide a complete list of parameters and value ranges. In some cases, the first LCD display in a chart may not be the first one you see. You may need to cycle through the displays (by pressing the button repeatedly) until you reach the desired LCD display.

Button 7 LCD Display

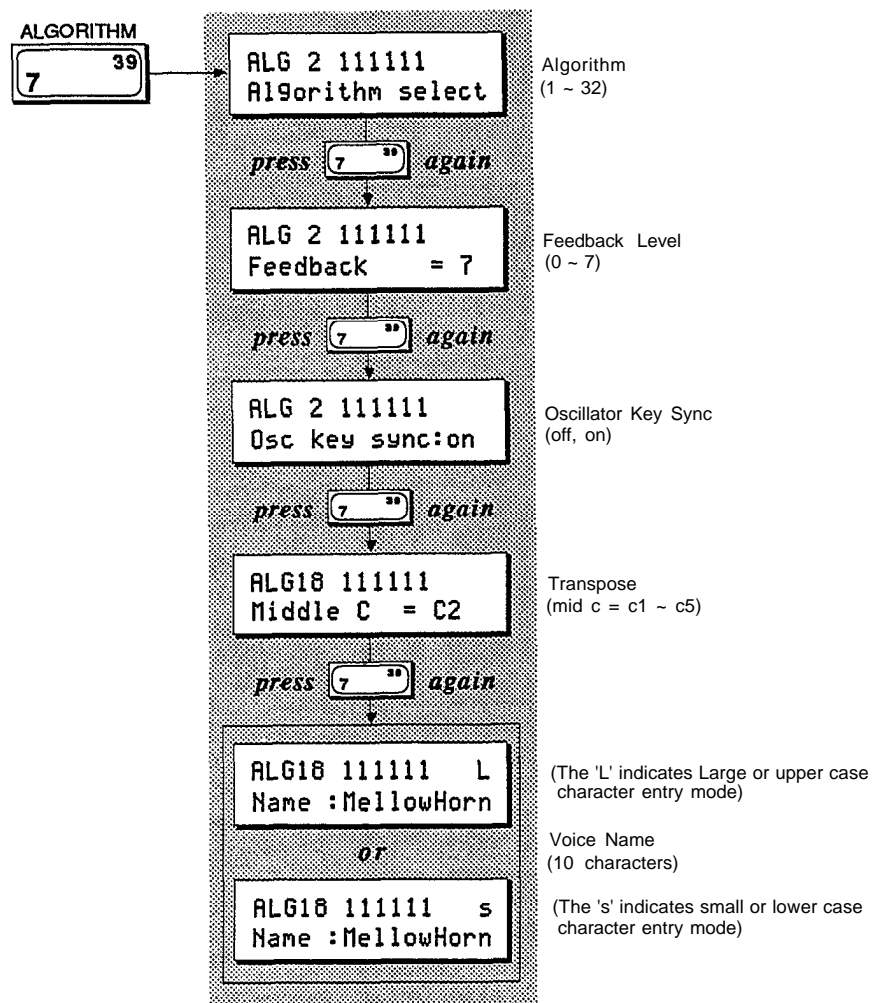

Button 8 LCD Display

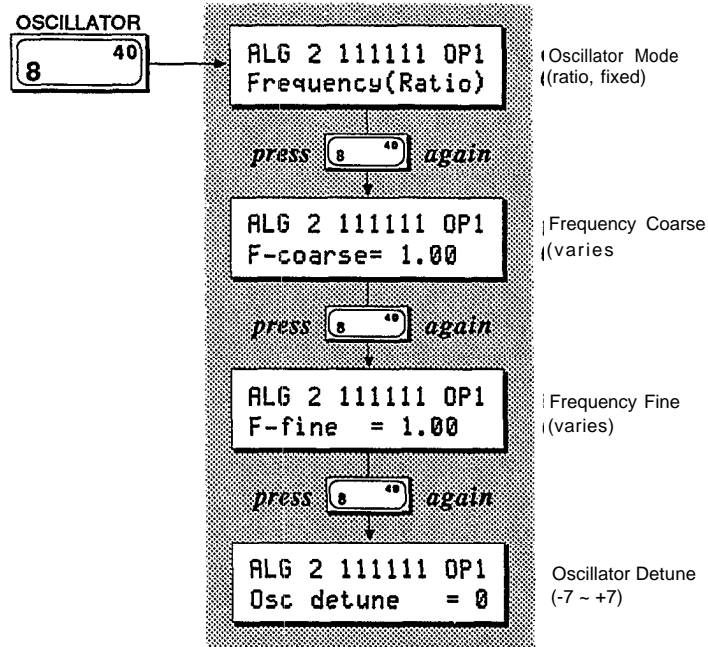

Button 9 LCD Display

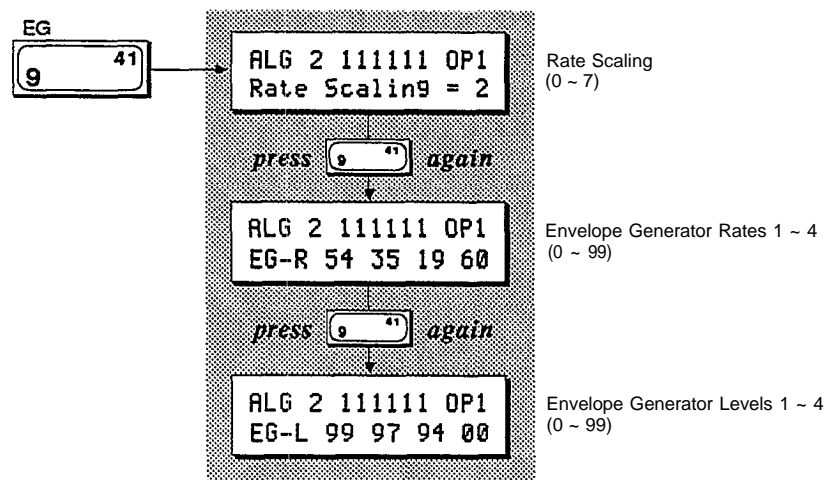

Button 10 LCD Displays

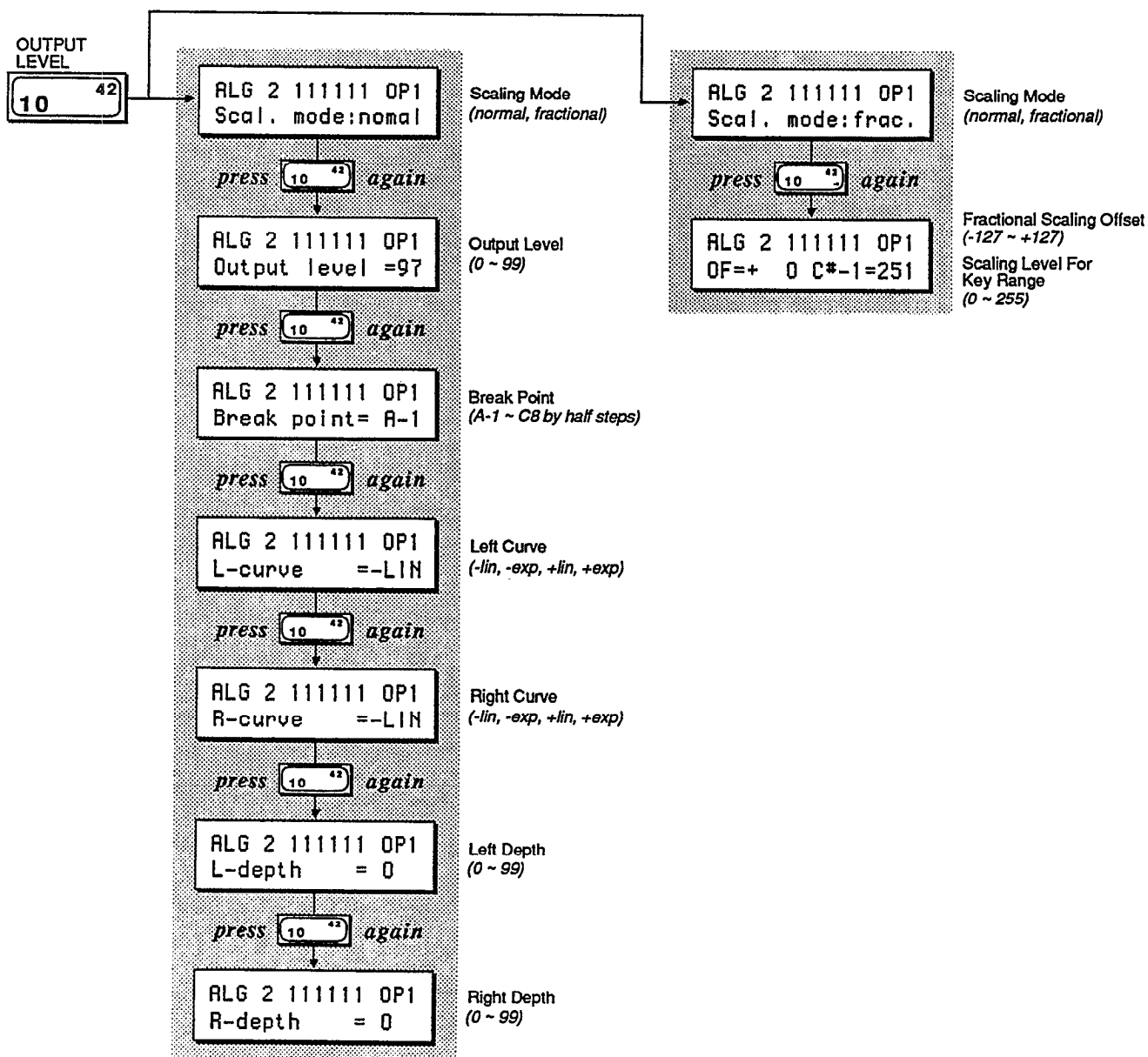

Button 11 LCD Display

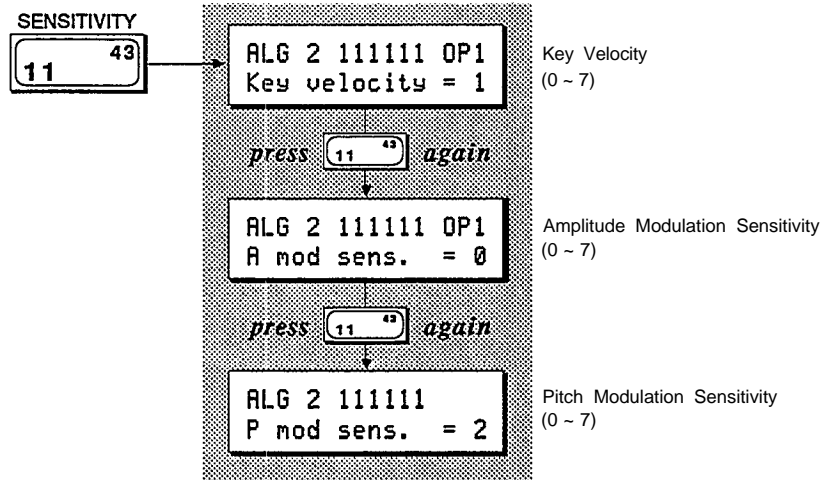

Button 12 LCD Display

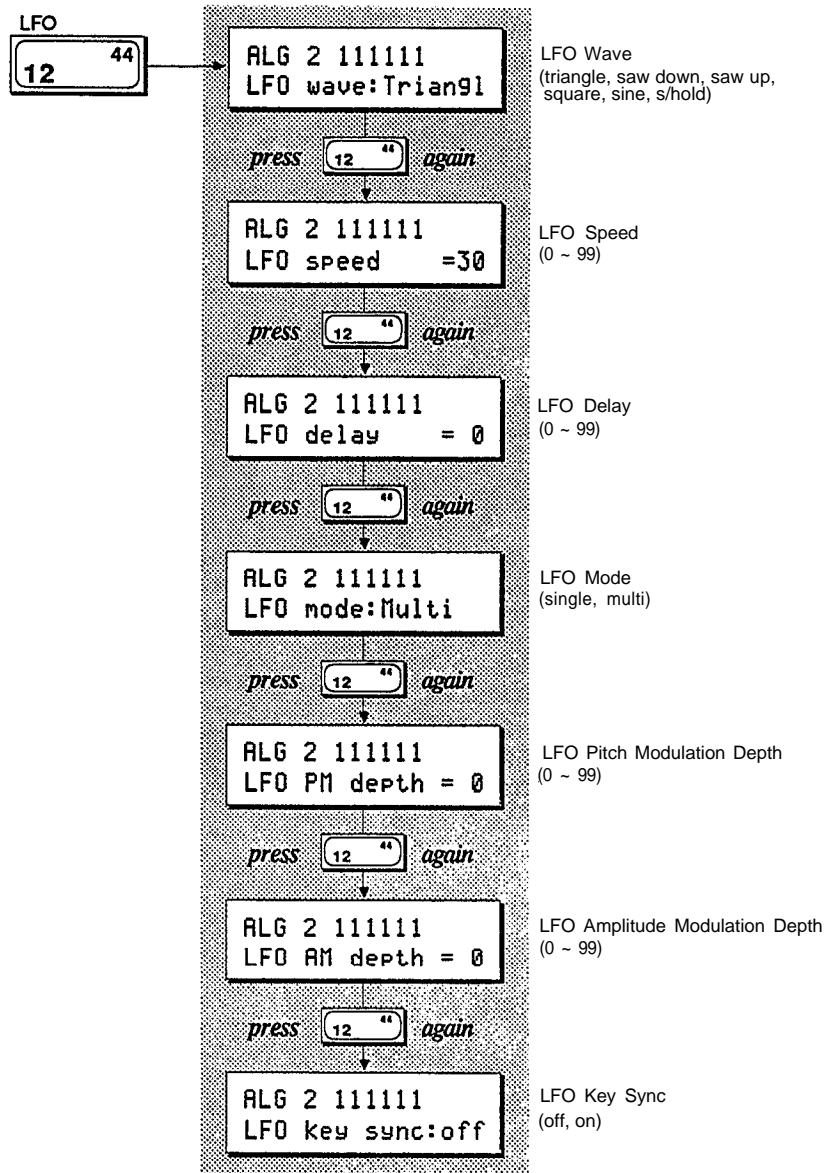

Button 13 LCD Display

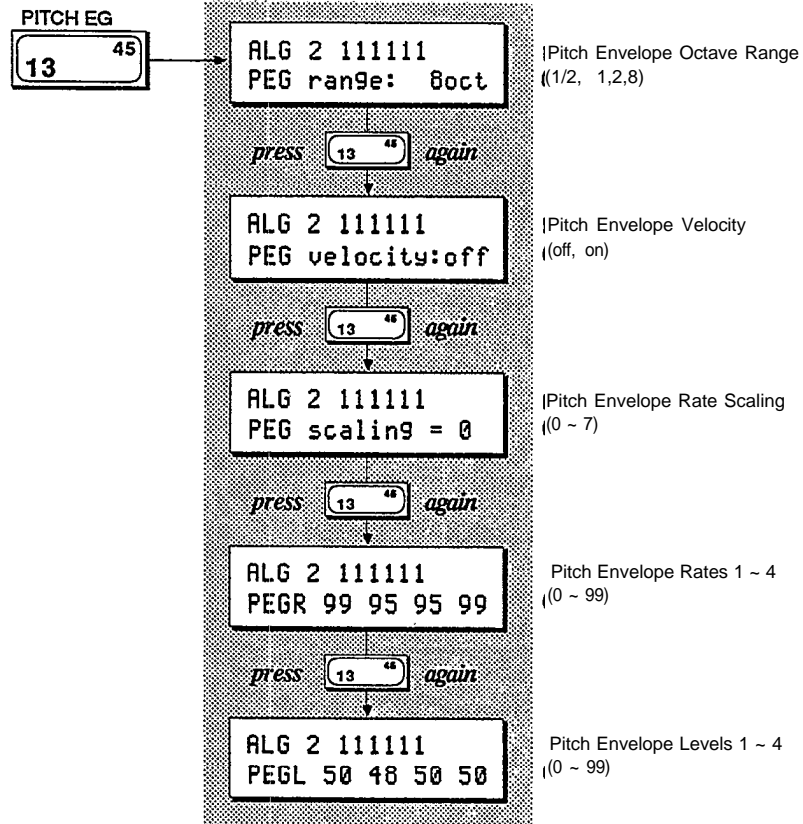

Button 23 LCD Displays

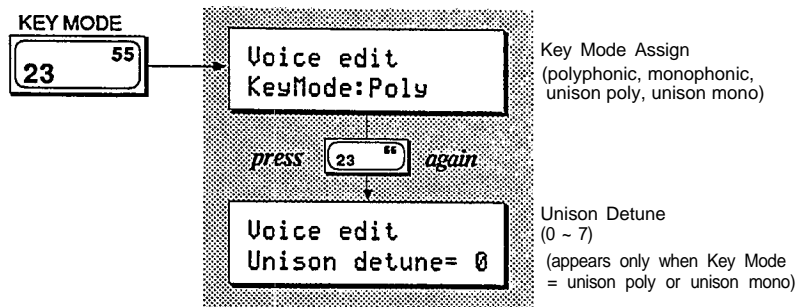

Button 24 LCD Displays

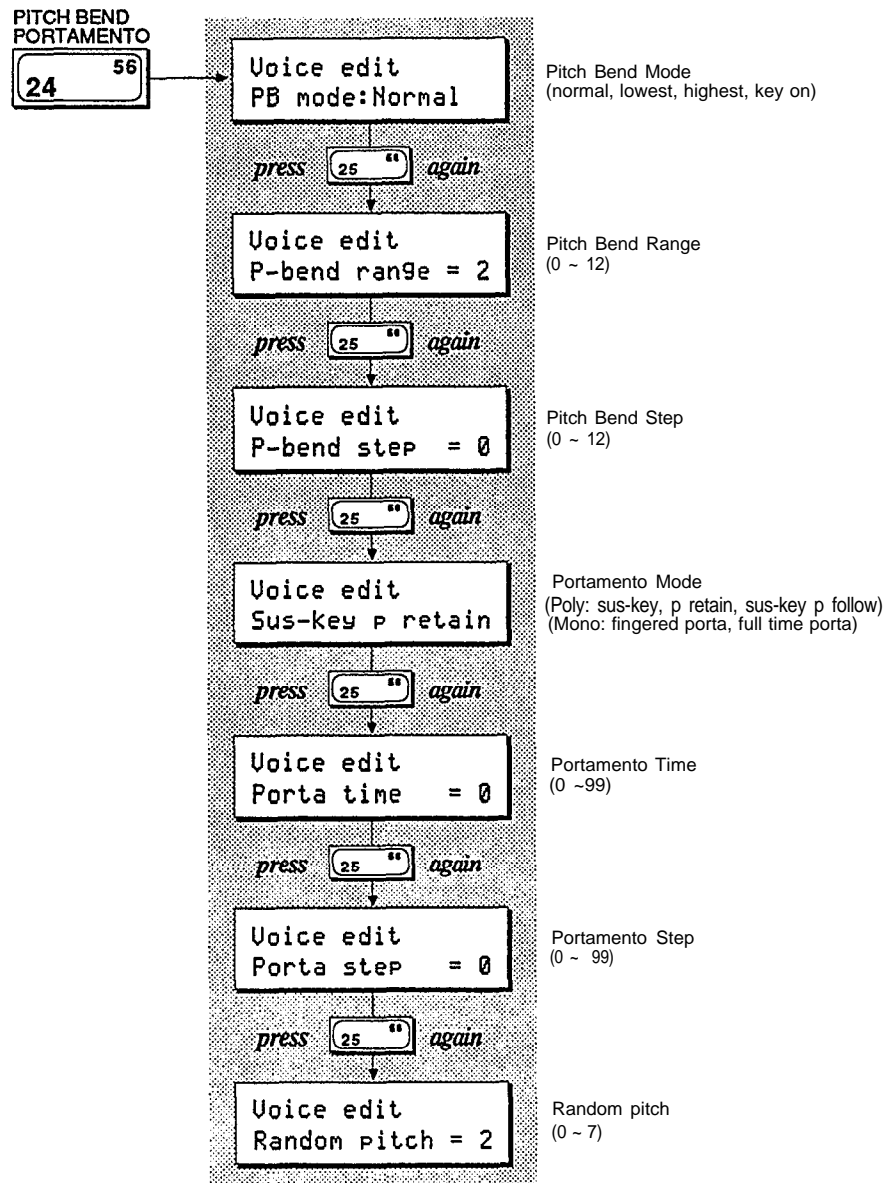

Button 25 LCD Displays

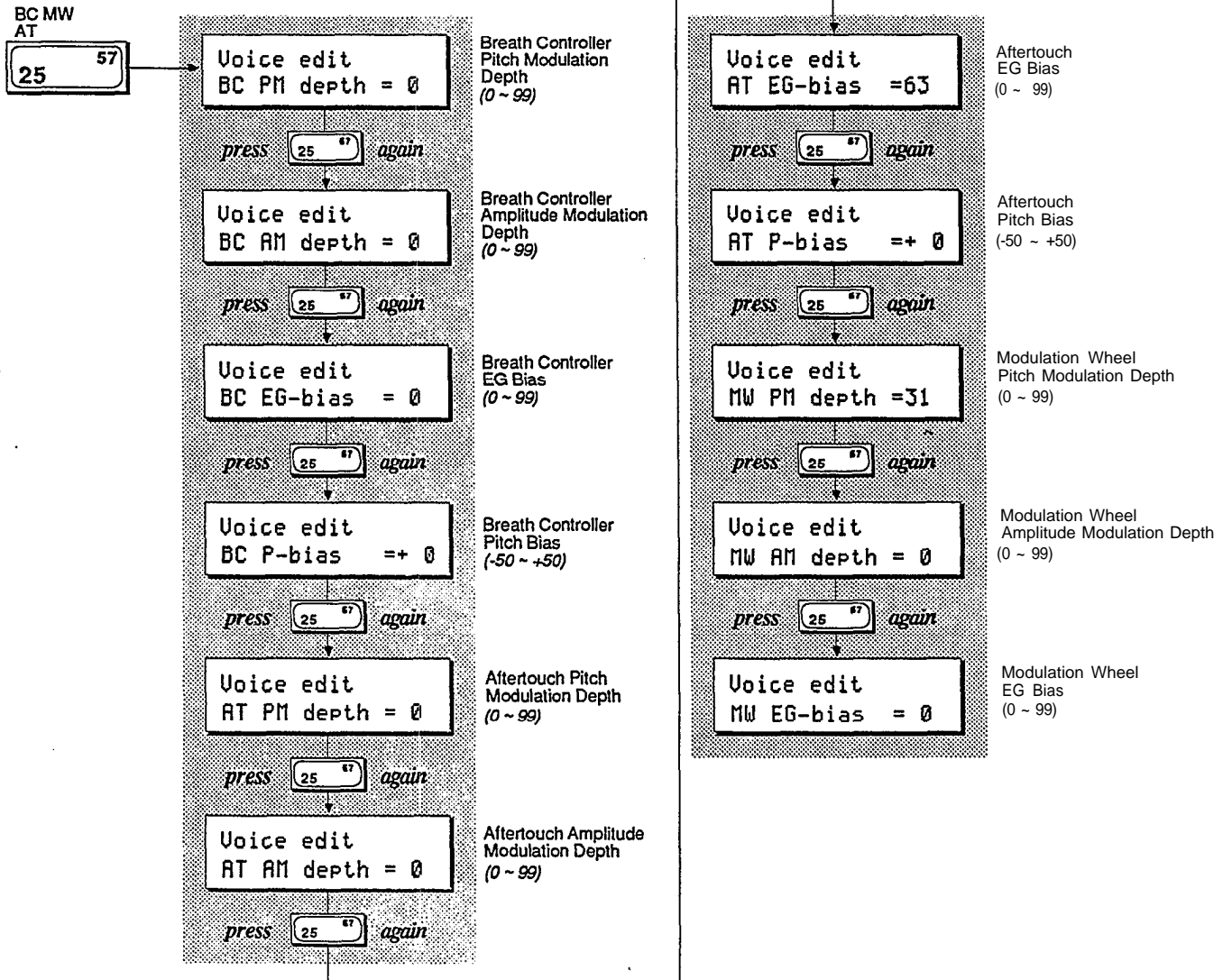

Button 26 LCD Displays

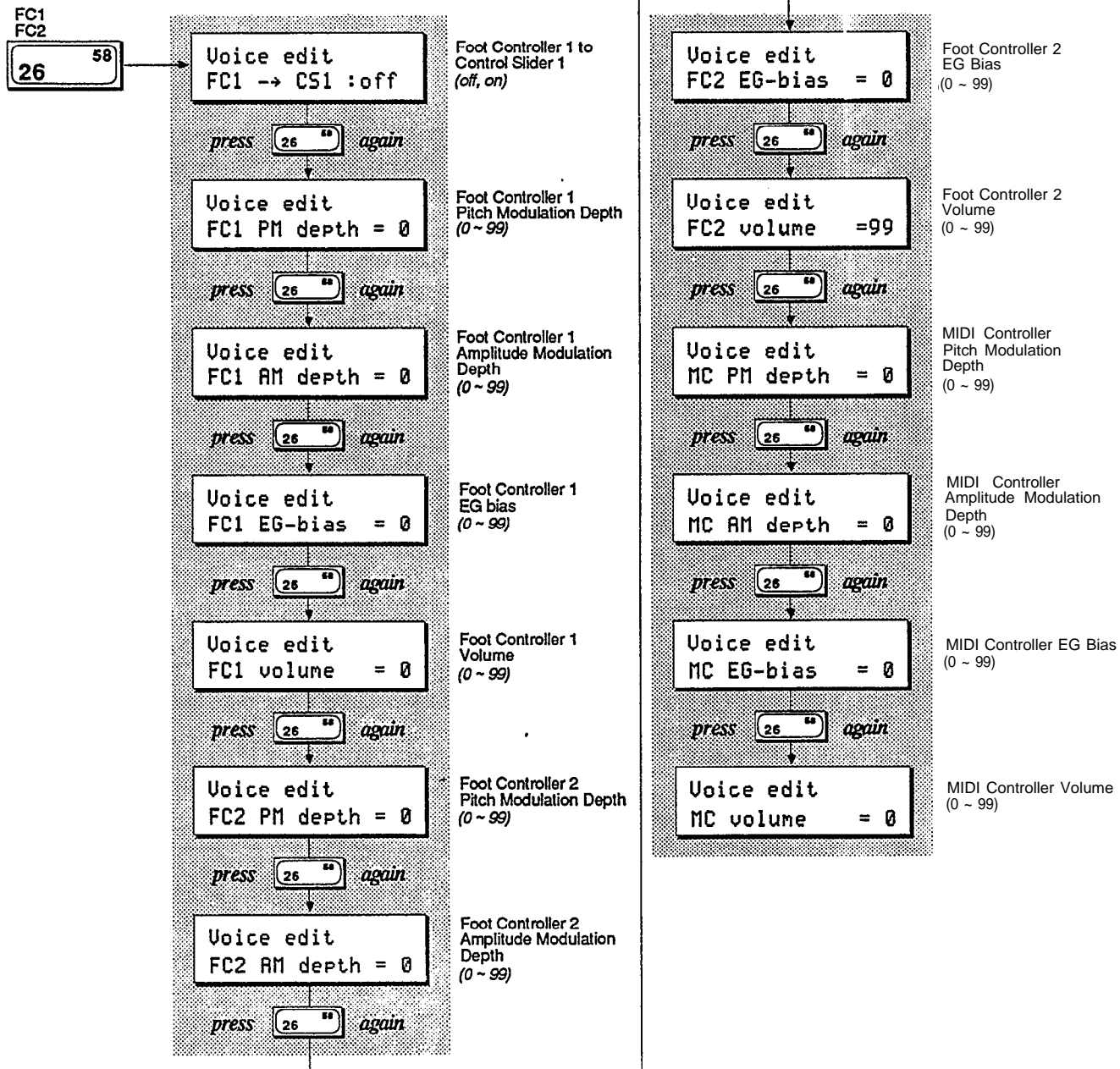

Basic Voice Editing Functions

Voice editing is easier on the DX7s, thanks to the direct operator access provided by buttons 1 ~ 6 and 17 ~ 22.

Operator Select

The parameters accessed using buttons 8 ~ 11 are adjustable for each of the six operators. While editing Voice data, buttons 1 ~ 6 provide a quick way to move from one operator to another. The number of the operator that has been chosen will appear in the upper right corner of the LCD.

Operator On/Off

In order to adjust the settings for the six operators accurately, it is useful to focus on the sound of certain operators by turning off the output of ones not being edited. While editing Voice data, buttons 17 ~ 22 provide a quick way to turn the six operators on and off. The on/off status of the six operators is shown in the center of the upper line of the LCD. When all six operators are turned on, you will see 111111. When an operator is turned off, a 0 will appear in the corresponding position of the display.

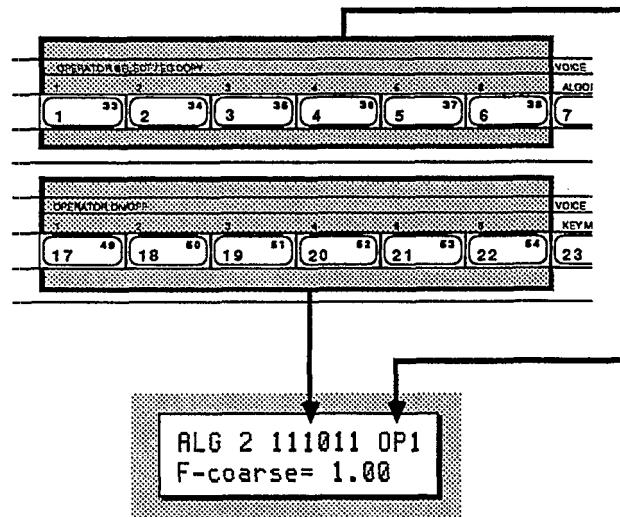

EG Copy

The EG Copy function from the original DX7 is retained in the DX7s, and is made easier through the use of buttons 1 ~ 6. Once you have envelope data you want to copy displayed in the LCD, simply press and hold the Store/EG Copy button. You can then choose the copy destination using buttons 1 ~ 6.

New Voice Parameters

The basic voice of the DX7s is almost exactly the same as that of the original DX7, assuring complete compatibility between the old and new instruments. To discover the additional voice parameters of the DX7s, read on.

Pitch Envelope

The Pitch Envelope operates as it did in the original DX7, but some new features have been added. The potential depth of the Pitch Envelope effect can now be adjusted using the Range parameter:

Range	Maximum Pitch Change Range
1/2	6 semitones
1	1 octave
2	2 octaves
8	8 octaves

Representative Pitch Envelope
Generator shape.

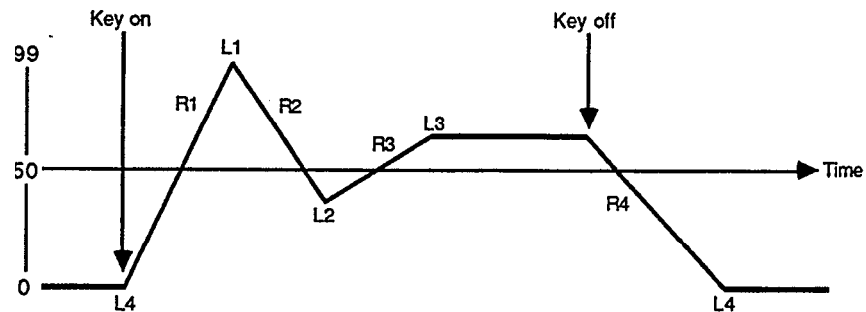

In addition, the Velocity parameter allows you to control the intensity of the Pitch Envelope with keyboard touch. There is also a scaling parameter that lets you change the speed of the pitch envelope as you move up the keyboard.

LFO

There was only one LFO in the original DX7, so all voices were affected in exactly the same way by the LFO settings. In the DX7s, there are sixteen LFOs, one for each voice. Even though all sixteen LFOs must have the same settings, they can now operate independently of each other if the LFO Mode parameter is set to Multi. If Mode is set to Single, the LFO will operate as it did in the original DX7.

Key Modes

The DX7s offers two Unison Key Modes, which create “fatter” sounds. Since these new Modes use more than one note of the DX’s sixteen-note capacity, they will affect the total number of notes available at any one time:

Key Mode	Number of Notes
Polyphonic	16
Monophonic	1
Unison poly	4
Unison mono	1

Voice Controllers

The DX7s features an expanded set of controller options. The settings for Pitch Bend Wheel, Modulation Wheel, Aftertouch, Breath Controller, and Foot Controllers 1 and 2 are adjusted in Voice Edit Mode, using buttons 24 ~ 26 (The other controller settings are accessed in Performance Edit Mode.)

Function Data and Voice Effect Data

The original DX7 separated its operational parameters into two groups: Voice data and Function data. Voice data encompassed all parameters used to create a Voice, and Function data involved settings for the various performance Controllers. The DX7 only had memory to store one set of Function settings, so all Controllers operated in the same way for all Voices.

In the DX7s, Function data has been replaced by Voice Effect data (adjusted using buttons 23 ~ 26). This Voice Effect data can be adjusted as part of each Voice Memory — this means that each Voice can have its own Controller settings.

Most of the Voice Effect parameters are exactly the same as the Function parameters of the original DX7. The new parameters are outlined below.

Pitch Bend Modes

The Pitch Bend Wheel in the DX7s functions in one of four basic Modes, which operate as follows:

*Pitch Bend Modes
on the DX7s.*

Pitch Bend Mode	Chord notes affected	Applied to sound sustained by foot switch?
Normal	all notes	yes
Lowest	lowest note only	yes
Highest	highest note only	yes
Key-on	all notes	no

Foot Controller 1 and 2

The DX7s provides memory space to set the operation of two Foot Controllers. Foot Controller 1 also has a new parameter possibility. It can be set to control the same Voice parameter as that of Continuous Slider 1. (For more on the available settings for CS 1, see Section 3 of this manual.) Since CS 1 operates in Performance Mode, this use of Foot Controller 1 is also confined to Performance Mode.

Pitch Bias

With the new Pitch Bias feature you can use After Touch or the Breath Controller to control the pitch of a voice. When Pitch Bias is set to 0, there is no pitch change. Positive Pitch Bias settings result in an upward bend, while negative Pitch Bias settings cause the pitch to bend down. The range is -50 ~ +50.

Fractional Scaling

One of the most important aspects of DX7 voicing is Level Scaling, which allows adjustment of each operator's output over the range of the keyboard. The DX7s offers the possibility of even more subtle control over operator outputs, through Fractional Scaling.

Fractional Scaling and Level Scaling

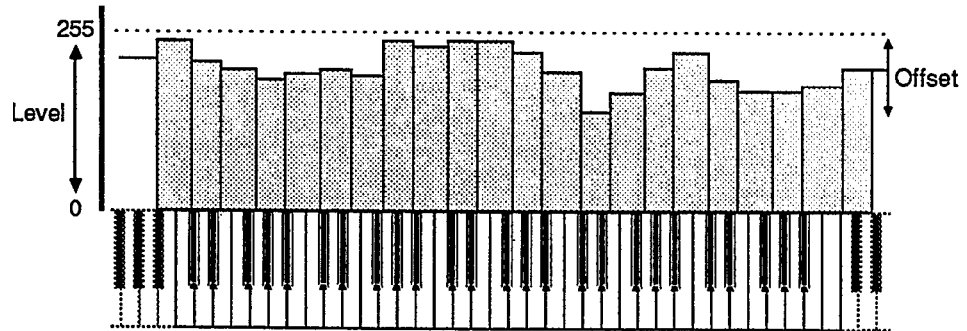

Although the DX7's Level Scaling offers a great deal of interaction between timbre and frequency, Fractional Scaling offers even greater precision. The level can be set independently in groups of three notes, over the entire range of the keyboard. To provide even more control, the resolution of the level settings has been expanded from 0 ~ 99 to 0 ~ 255:

Fractional Scaling allows you to adjust the output level of each operator for three-note groups.



Fractional Scaling Editing and Storage

Entering Fractional Scaling Edit Mode

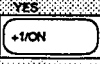
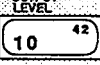

- 1  Press the Voice button.
- 2  Press the Edit button.
- 3  Press the Output Level button (#10) to access the Scaling mode LCD display.
- 4  Press the +1/YES button to select Fractional Scaling Mode (called "frac" in the LCD display).
- 5  Press the Output Level button (#10) again to access the Fractional Scaling Edit LCD display.

*Editing
Fractional Scaling
Data*

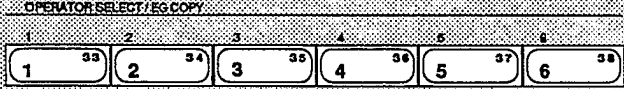
1  Press the right cursor button to select the Note Group Edit parameter.

2  Use the Operator Select buttons (#1~6) to choose the operator whose scaling you wish to edit.

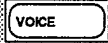
3 Press and hold a key in the note group you wish to edit.

 or 

While holding the key, press either the Voice button or the INT/CRT button. The note group you have selected will be shown next to the blinking cursor in the LCD.

OR

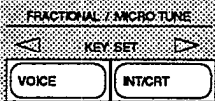
3  Use the Voice and INT/CRT buttons as left and right cursors to move the desired note group into position next to the blinking cursor in the LCD.

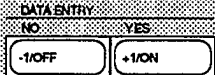
4  Use the data entry slider or the +1/-1 buttons to edit the value for the selected note group.

*Storing
Fractional Scaling
Data*

1 Make sure that a properly formatted Cartridge (FKS-Y) is inserted in the cartridge port.

2  Press the Voice button.

3  Press and hold the Store button.

4  Use the number buttons to select the desired memory location. NOTE: The Fractional Scaling data will be linked to the Internal Performance memory with the same location number.

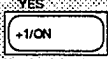
5  While still holding the Store button, press the +1/YES button.

Section 5
Memory Functions

Section 5 Contents

61	Utility Buttons
62	Button 14 LCD Displays
63	Button 15 LCD Displays
64	Memory Types
64	Voice & Performance Memory
65	System Setup Memory
65	Micro Tuning Memory
65	Fractional Scaling Memory
65	Initialized Memory
65	Current Play/Edit Memory
65	Compare/Recall Memory
66	Memory Storage Types
66	Internal Memory
66	Cartridge Memory
67	ROM Cartridge
68	Basic Utility Functions
68	Master Tune
68	Recall Edit
68	Initialize
69	Cartridge Memory Functions
69	Using Cartridge Data
70	Formatting a RAM Cartridge
70	Loading Voice & Performance Data from a RAM Cartridge

Utility Buttons

All of the memory functions (and related utility functions) are adjusted via the LCD displays called up using buttons 14 and 15. Both of these buttons call up multiple LCD displays. The charts below show all of the displays called up by each button, and provide a complete list of parameters and value ranges. In some cases, the first LCD display in a chart may not be the first one you see. You may need to cycle through the displays (by pressing the button repeatedly) until you reach the desired LCD display.

Utility Edit Keys

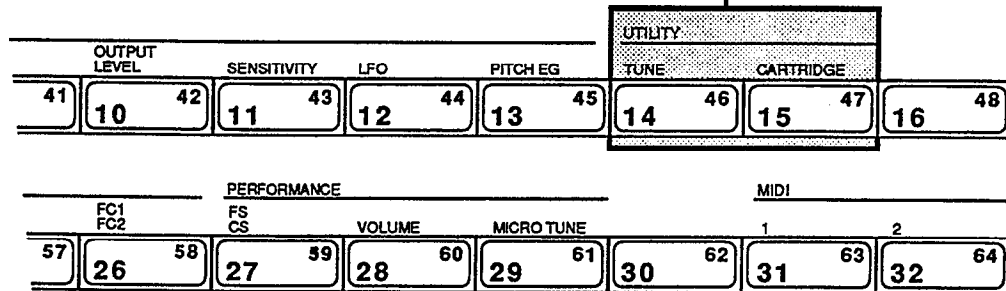

Button 14 LCD Displays

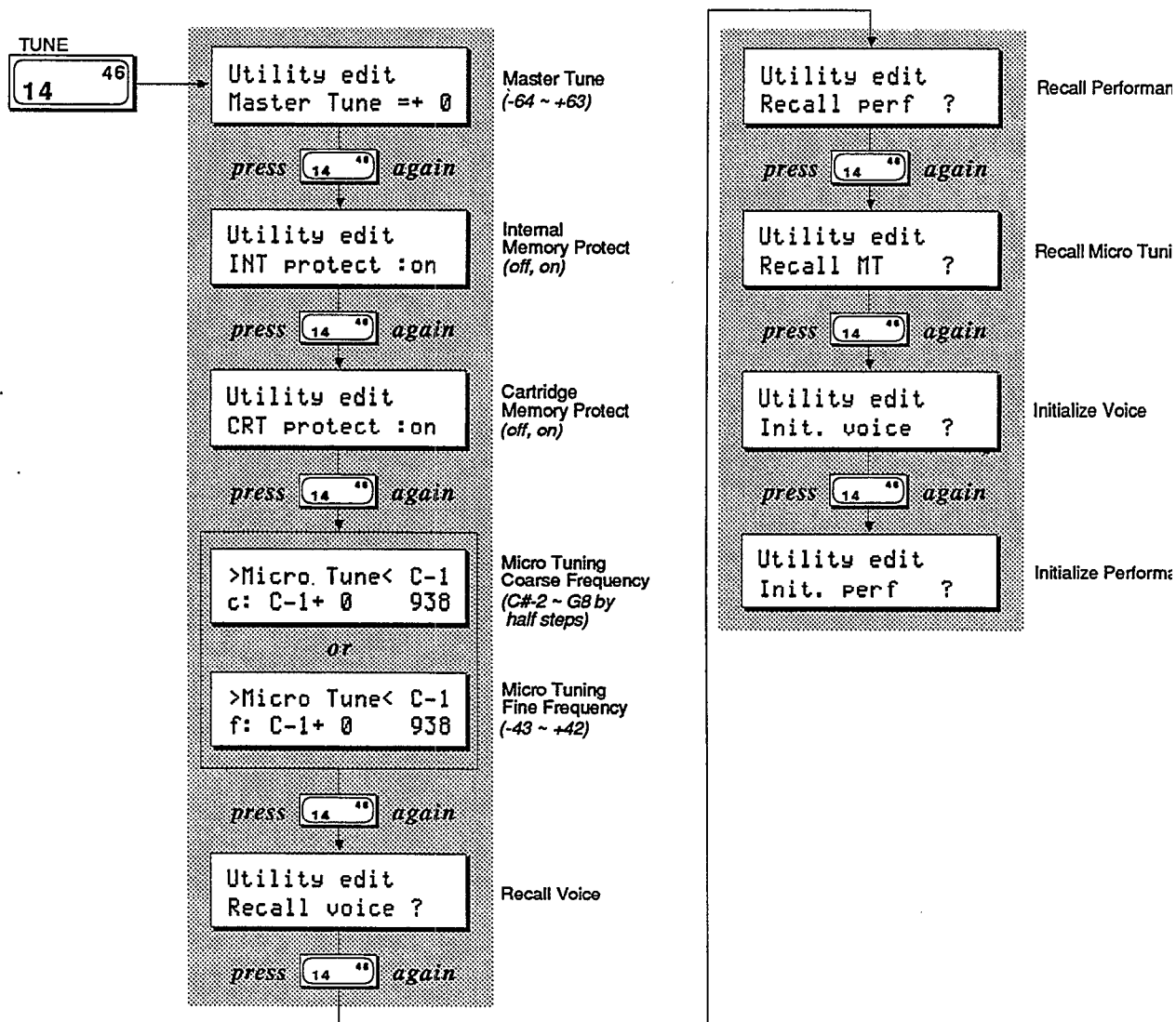

Button 15 LCD Displays

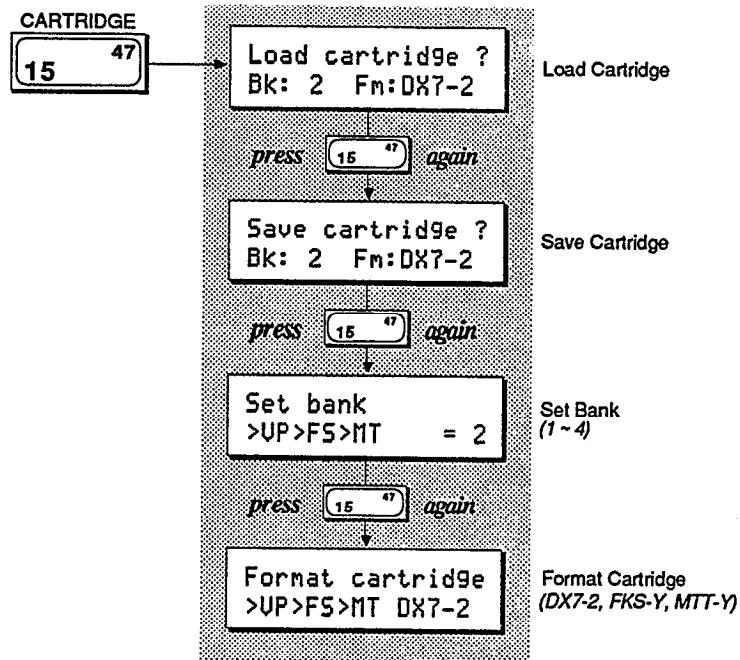

Memory Types

The chart below is a graphic representation of the way all the different DX7s memory areas interact with one another. Since there are many facets to the memory layout of the DX7s, it may look intimidating at first. Once you become more familiar with the instrument, though, you will find the memory layout is much simpler than it first appears. To understand all of the memory types, study the diagram and read the explanation below:

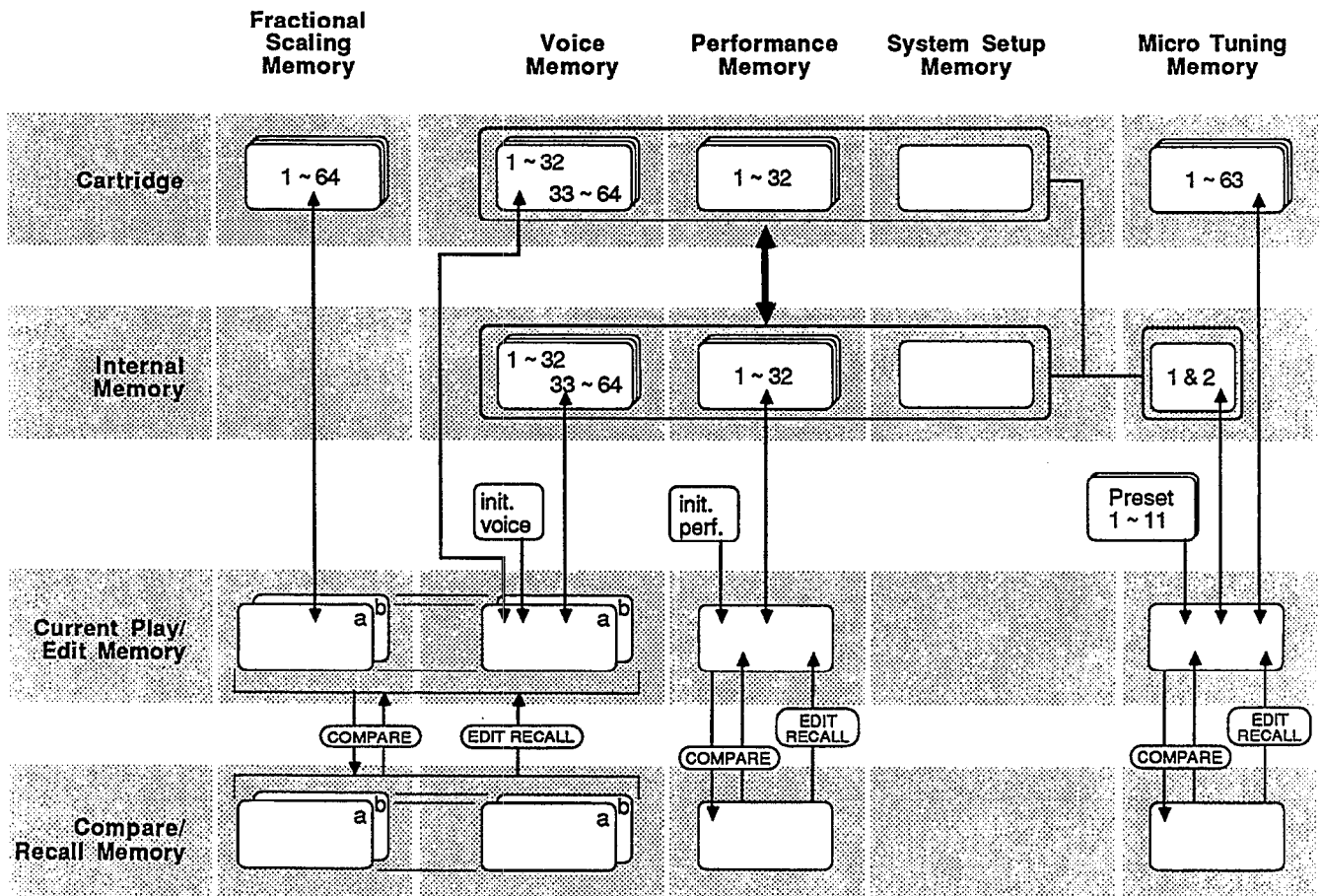

Voice & Performance Memory

This Memory block includes data for 64 Voice Memories and 32 Performance Memories, plus one System Setup Memory and two User-defined Micro Tunings.

System Setup Memory

System Setup Memory contains most of the basic MIDI settings. System Setup is always retained in Internal Memory, along with the Voice & Performance Memory and the two User-defined Micro Tunings. For more information on System Setup Memory, see Section 6 of this manual.

Micro Tuning Memory

The DX7s contains eleven Micro Tunings as part of its permanent memory. In addition, two User-defined Micro Tunings are stored as part of Voice & Performance Memory. Using a RAM cartridge, it is also possible to store up to 63 Micro Tuning Memories.

Fractional Scaling Memory

Fractional Scaling data cannot be stored in the DX's Internal Memory. In order to use Fractional Scaling data with Internal Voice Memories, the data must reside in a RAM (or ROM) cartridge installed in the DX's cartridge port.

Initialized Memory

For those who wish to create Voice Memories or Performance Memories from scratch, the DX7s provides both Voice and Performance "blank page" data as part of its permanent memory. If you want to start from ground zero (instead of working from an already-existing Voice or Performance Memory), call up the DX's Init Voice or Init Performance data (using button 14 in Edit Mode).

Current Play/Edit Memory

Whenever you call up a Voice Memory or Performance Memory in Play Mode, you are actually sending it to a special location in the DX7s — the current Play/Edit Memory. As the name indicates, this is also the location where Voice or Performance data is edited. In computer terminology, this memory location is often called the Edit Buffer.

Compare/Recall Memory

When you are editing a Voice or Performance and use the Edit/Compare feature, the original Voice data is loaded into the Play/Edit Memory (so you can hear it). The edited Voice data is moved temporarily into another memory location, the Compare/Recall Memory. In computer terms, this memory location might be called the Compare Buffer. When you engage the Recall Edit function for the various Internal Memory types, you are actually recalling the last data moved to the Compare/Recall Memory.

Memory Storage Types

In addition to having a number of distinct types of memory, the DX7s offers a number of ways to store these various memories. To understand how the various memory storage possibilities interact, read on.

Internal Memory

The DX's Internal Memory holds a standard Voice & Performance Memory block, which consists of the following: 64 Voice Memories, 32 Performance Memories, 1 System Setup Memory, and 2 User-defined Micro Tuning Memories. Voice & Performance Memory can also be stored in Cartridge Memory.

Cartridge Memory

A DX RAM4 cartridge can store three different types of data: Voice & Performance, Fractional Scaling, and Micro Tuning.

The RAM4 Voice & Performance Memory is equivalent to the Internal Voice & Performance Memory.

The RAM4 Fractional Scaling Memory holds up to 64 Fractional Scalings, which are tied to the 64 Voices in the DX's Internal Memory.

The RAM4 Micro Tuning Memory holds up to 63 Micro Tunings.

The RAM4 cartridge can be used to store one of three possible kinds of data.

Possible RAM4 Contents

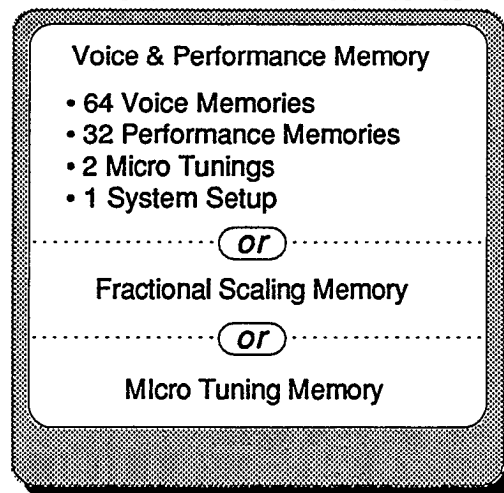

ROM Cartridge

The supplied ROM cartridge contains 4 banks, which can be accessed using button 15 in Edit Mode:

The supplied ROM cartridge holds a number of different kinds of DX memory.

Contents of Supplied ROM Cartridge

Bank 1	Voice & Performance Memory <ul style="list-style-type: none">• 64 Voice Memories• 32 Performance Memories• 2 Micro Tunings• 1 System Setup
Bank 2	Voice & Performance Memory <ul style="list-style-type: none">• 64 Voice Memories• 32 Performance Memories• 2 Micro Tunings• 1 System Setup
Bank 3	Fractional Scaling Memory
Bank 4	Voice & Performance Memory <ul style="list-style-type: none">• 64 Voice Memories• 32 Performance Memories• 2 Micro Tunings• 1 System Setup

The first two banks are Cartridge Voice and Performance data. The third bank contains Fractional Scaling data, and the fourth bank has the original Internal Voice and Performance data. Banks 1 and 2 can be loaded to the Internal memory, but if you try to choose a Performance, you will still need to have the cartridge inserted. This happens because the Performance memories are calling Cartridge Voices. For instance, the first Performance in ROM Cartridge bank 1, SolidStrg, calls up voice C12 (cartridge voice 12). If you want to load the original Voice and Performance data into the Internal memory, you will have to load from bank 4 of the ROM Cartridge. Banks 1 and 4 are identical, except that the Performances in bank 1 call up Cartridge Voices, while the Performances in bank 4 call up Internal Voices.

Basic Utility Functions

Most of the basic Internal Memory Utility functions are accessed using button 14 in Edit Mode, as follows:

Master Tune

This sets the tuning of the DX7s relative to its internal A-440 reference.

Recall Edit

These functions can be used to recall Voice, Performance, or Micro Tuning data from the DX's Compare/Recall Memory. Edit Recall is particularly useful if you forget to save a Voice, Performance, or Micro Tuning and don't realize it until later. The data you edited last will always be in the compare/recall buffer and can be recalled and stored using this function.

Initialize

These functions can be used to call up the DX's Initialized Voice or Performance Memories, if you wish to create Voice or Performance data from scratch.

Cartridge Memory Functions

RAM cartridges are useful storage centers for Voice & Performance data. To understand the basic Cartridge Utility functions, read on.

Using Cartridge Data

Except for the two User-defined Micro Tunings that are part of the DX's Internal Voice & Performance Memory, Cartridge Memory is the only location from which Micro Tuning and Fractional Scaling data may be recalled for immediate use. If you create Voice or Performance data that involves Cartridge Memory (for either Fractional Scaling or Micro Tuning), the DX7s will remind you as follows:



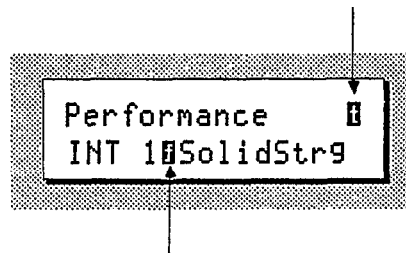

LCD display indicating that required Fractional Scaling or Micro Tuning data is not available. When the needed data is supplied via a RAM cartridge, these displays disappear.

This symbol signifies that the indicated Performance memory was created to include Micro Tuning from a RAM cartridge, but the RAM cartridge with the necessary Micro Tuning data is not inserted in the instrument's cartridge port.



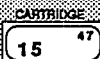

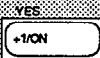
This symbol signifies that the indicated Voice Memory was created with Fractional Scaling, but the RAM cartridge with the necessary Fractional Scaling data is not inserted in the instrument's cartridge port.

Formatting a RAM Cartridge

- 1** Insert an unformatted RAM cartridge in the cartridge port.
- 2**  Press the Edit button.
- 3**  Press the Cartridge button (#15) until you access the Format Cartridge LCD.
- 4**  Use the Poly/Mono and Key Shift buttons as left and right cursors to select the type of formatting you desire.
- 5**  Press the +1/YES button. The LCD display will ask "Are you sure?"
- 6**  Press the +1/YES button once more.

Loading Voice & Performance Data from a RAM Cartridge

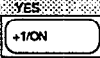
- 1** Insert a Voice & Performance RAM cartridge into the cartridge port.
- 2**  Press the Edit button.
- 3**  Press the Cartridge button (#15) to access the Cartridge Save/Load LCD display.
- 4**  Press the +1/YES button. The display will ask "Are you sure?"
- 5**  Press the +1/YES button once more.

Section 6
MIDI Functions

Section 6 Contents

73	MIDI Buttons
73	Button 31 LCD Displays
74	Button 32 LCD Displays
75	System Setup
75	Transmit Channel
75	Receive Channel
75	Omni Mode
75	Local On/Off
75	MIDI IN Control Number
75	CS 1 and CS 2 Controller Numbers
76	Note On/Off
76	Program Change Transmission
76	Program Change Memory
76	After Touch
77	MIDI System Exclusives
77	MIDI Device Number
77	Transmit and Receive Block
77	MIDI Out
78	Immediate MIDI Program Change Out

MIDI Buttons

All of the MIDI functions and parameters are adjusted via the LCD displays called up using buttons 31 and 32. Both of these buttons call up multiple LCD displays. The charts below show all of the displays called up by each button, and provide a complete list of parameters and value ranges. In some cases, the first LCD display in a chart may not be the first one you see. You may need to cycle through the displays (by pressing the button repeatedly) until you reach the desired LCD display.

Button 31 LCD Displays

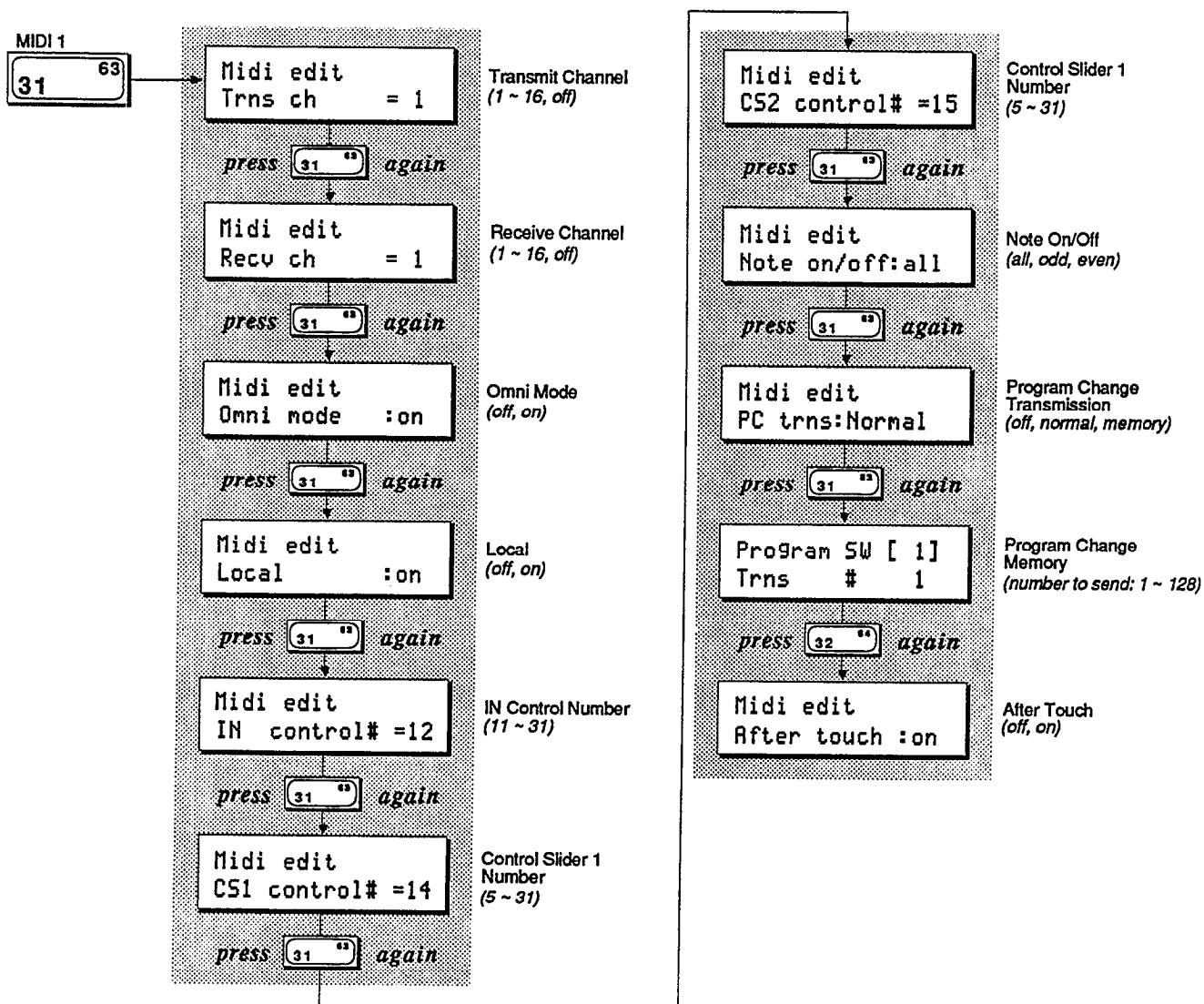

Button 32 LCD Displays

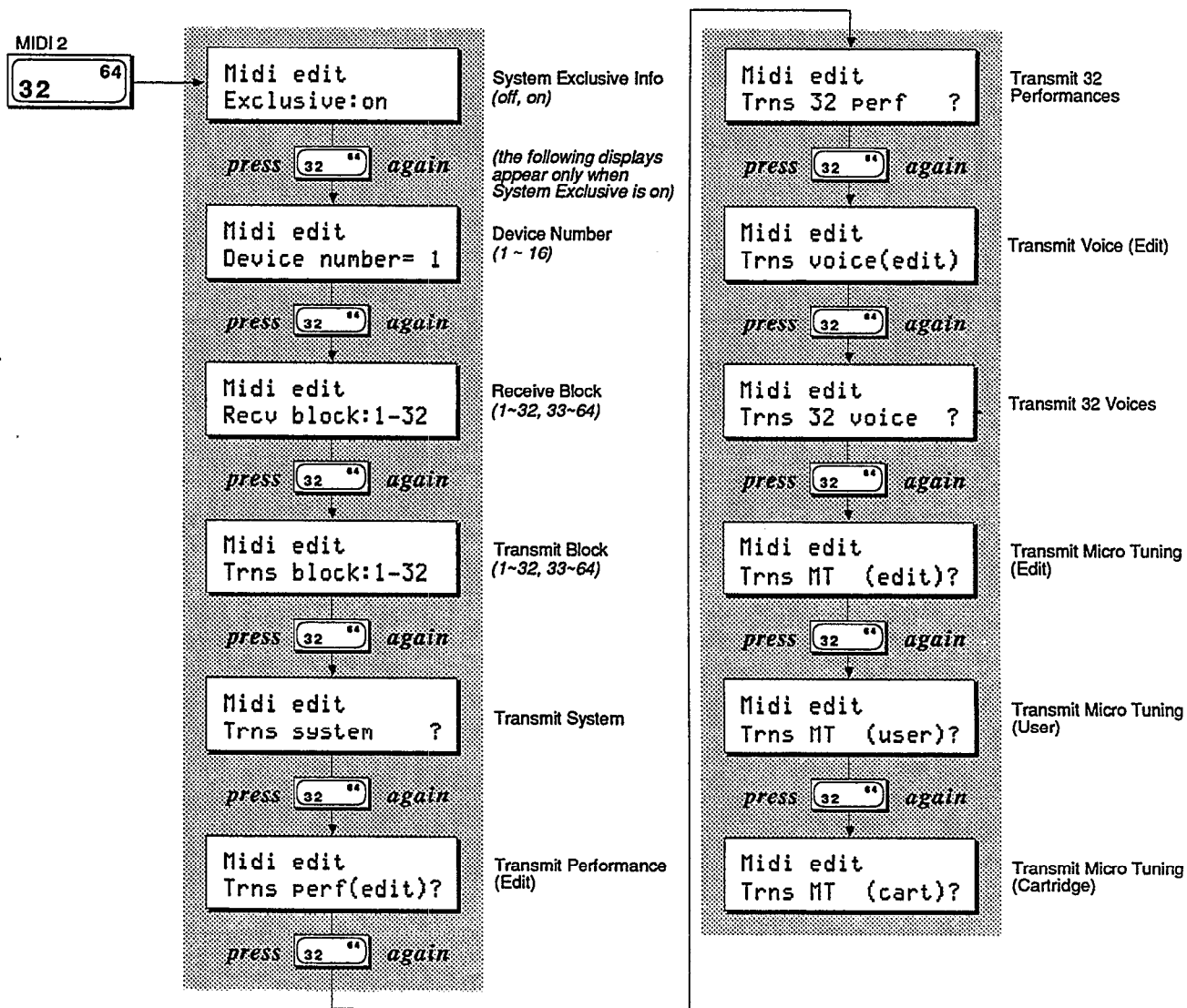

System Setup

Since the use of many basic MIDI functions might depend on the contents of a specific set of Voice & Performance data, the DX7s provides a special memory location, System Setup Memory, to store basic MIDI parameters and other data in conjunction with a Voice & Performance Memory block. This System Setup Memory contains settings for the following parameters:

Transmit Channel

This parameter allows you to set the DX's MIDI transmit channel. If you turn this parameter off, no MIDI data will be sent.

Receive Channel

You set the DX's MIDI receive channel with this parameter. If you turn this parameter off, all incoming MIDI data will be ignored.

Omni Mode

When Omni mode is on, the DX7s will receive MIDI data from all of the 16 MIDI channels (the MIDI receive channel is disregarded).

Local On/Off

If Local is set to off, notes played on the DX7s keyboard will not engage the DX's internal sound mechanism. Turning Local off has no effect on the transmitted MIDI data.

MIDI IN Control Number

This parameter sets the MIDI controller number for the MIDI Controller (MC) functions programmed with each voice. The function of this controller is set via button 26 (see page 51).

CS 1 and CS 2 Controller Numbers

The CS 1 and CS 2 Controller Number parameters have two functions:

1. To set the controller numbers that will be transmitted by CS 1 and CS 2 via the MIDI out. This is useful for controlling external MIDI instruments.
2. To set the controller numbers that will control the voice parameters assigned to CS 1 and CS 2 in the Performance data. This is useful for changing voice parameters from an external MIDI device.

Note On/Off

This parameter works with MIDI receive only. It's usually set to "all," meaning that all Note On information received at the DX's MIDI In will play a note. If the Note On/Off parameter is set to "even," it will only play notes that have even MIDI note numbers. Similarly, if this parameter is set to "odd," the DX7s will only play notes that have odd MIDI note numbers. This can be used in conjunction with other MIDI instruments to produce a variety of interesting effects. Since the Note On/Off parameter works with MIDI receive only, it won't produce any noticeable effect when you play the DX7s keyboard.

Program Change Transmission

If the DX7s is connected to another MIDI instrument, various levels of MIDI communication are possible. The MIDI Program Change Mode determines how the DX7s will relate to an external MIDI instrument.

- Off program changes on the DX7s will have no effect on an external unit
- Normal a program change on the DX7s will send the same Program number to the external unit
- Memory the program changes sent will be those programmed in the Program Change Memory LCD

Program Change Memory

The Program Change Memory allows you to transmit a different MIDI program change number for each of the DX7s number buttons. CS 1 selects 1 of the 64 program switches, and CS 2 selects the program change number that will be sent. The Program Change Memory only determines which program change number will be transmitted via MIDI and has no effect on the selection of DX7s memories.

After Touch

You can disable MIDI transmission of After Touch data with this parameter. After Touch will still affect the DX7s voices normally when this parameter is turned off. The After Touch parameter is not saved with the System Setup data.

MIDI System Exclusives

If you use the DX7s as part of a MIDI system, there are a number of advanced MIDI functions available for your use:

MIDI Device Number

If the DX7s is connected to another Yamaha product, this parameter must be used to set a Yamaha System Exclusive Device Number for MIDI System Exclusive data reception or transmission. The MIDI Device Number is saved with the System Setup data.

Transmit and Receive Block

A block of DX7s Voice data has thirty-two voices. You can independently set the Memory Transmit block and Memory Receive block to be either Internal Voices 1 ~ 32 or 33 ~ 64. Both of these parameters are saved with the System Setup data.

MIDI Out

Using these LCD displays, you can transmit various kinds of MIDI System Exclusive data from the DX's Internal Memory to an external instrument. These functions are useful if you are transmitting data to another instrument (such as another DX7s) that is capable of understanding and using it.

Immediate MIDI Program Change Out

This function allows you to send a program change number to an external MIDI tone generator without changing the program number on the DX7s.

If you wish to send a quick MIDI Program Change Message to an external MIDI unit, use the following procedure:

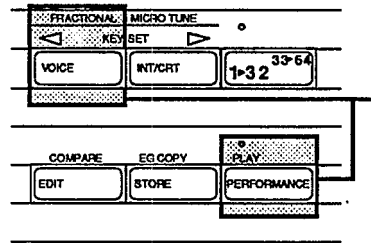

In either of the Play Modes (Voice or Performance), press and hold the button of the current Play Mode. You will see one of the following CD displays:

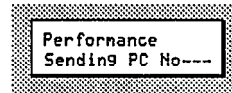
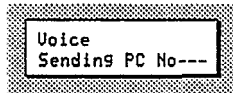

Now, while still holding the Play Mode button, type in the program change number you desire (1~128) using the 1~10 number buttons (1 through 0 character buttons). All three positions in the LCD must be filled: for example, to send program #1, type in 001.

Once you have typed in the third number, the program change you have typed in will be sent over MIDI to the instrument connected to your DX7s.

Appendices

Appendix 1: Supplemental Information

As mentioned at the outset, this manual has not attempted to cover all of the functions of the DX7s in exhaustive detail. To do so would have required a manual of large scale and density, one in which it would have been very difficult to locate specific information needed to *begin* using the DX7s.

For continuing information concerning the DX7s, consult AfterTouch, the official publication of the Yamaha Users Group. Many advanced functions will be discussed in its pages in the coming months. There will also be information concerning the availability of other material concerning more advanced applications. Some areas that will be covered in AfterTouch or in supplemental booklets include the following:

- Quick Reference Guide
- Memory Management
- Fractional Scaling
- Micro Tuning (Basic)
- Micro Tuning (Advanced)
- FM Voice Programming (Basic)
- FM Voice Programming (Advanced)
- Real-Time Parameter Changes
- Advanced Controller Usage
- Advanced MIDI Applications
- MIDI Technical Data & Charts

To receive a free copy of AfterTouch every month, send your request to AfterTouch, P.O. Box 2338, Northridge, CA 91323-2338. On your letter or postcard, be sure to indicate that you are the owner of a DX7s.

Appendix 2: Bibliography

Many of the basic functions of the DX7s are the same as those of the original DX7. Since there is a wealth of material available on the operation of the original DX7, this manual has focused on the new functions and features. For more information on the parameters and features that the new DX shares with the original DX7, consult the following:

DX7 Owner's Manual. (Available through your local authorized Yamaha dealer).

The Complete DX7, by Howard Massey; published by Amsco Publications; 1986.

FM Theory and Application, by Dr. John Chowning and David Bristow; published by Yamaha Music Foundation; 1986.

How to Understand and Program the Yamaha DX7, by Lorenz M. Rychner; published by Alexander Publishing; 1985.

The Secrets of Analog and Digital Synthesis, by Steve de Furia; published by Hal Leonard Publishing; 1985.

Yamaha Easy DX7; published by Yamaha Music Foundation and Hal Leonard Publishing; 1986.

Function	Transmitted	Recognized	Remarks
Basic Default Channel Changed	1-16 1-16	1-16 1-16	memorized
Mode Default Messages Altered	3 X X X X X X X X X X X X X X X X X	1, 2, 3, 4 POLY, MONO (M=1) x X 2	memorized
Note Number : True voice	36-96 X 1 X X X X X X X X X X X X X X X X	0-127 X 2 1-127	
Velocity Note ON Note OFF	o 9nH,v=1-127 x 9nH,v=0	o v = 1 - 127 x X 2	
After Key's Touch Ch's	x o 1 X	x o X 2	
Pitch Bender	0 X 1	o 0-12 semi X 2	7 bit resolution
Control Change	1 o X 1 2 o 1 X 4 o X 1 5 x 1 7 o X 1 64 o 1 X 65 o X 1 66 o X 1 67 o X 1 96 o X 1 97 o X 1 5-31 o X 1 11-31 x	o X 2 o X 2 o X 2 o X 2 o X 2 o X 2 o X 2 o X 2 o X 2 o X 2 o X 2 o X 2 o X 2 o X 2 o X 2 o (11-31) X 2 o X 2	Modulation wheel Breach control Foot Controller Portamento time Volume Sustain foot switch Portamento f switch Sostenuto soft Data entry + 1 Dara entry - 1 Continuous slider MIDI IN control
Prog Change : True #	o X 1 X X X X X X X X X X X X X X X X	o 0-127 X 2 0-127	64-127 : Cartridge
System Exclusive	o X 3	o X 3	Voice parameters
System : Song Pos : Song Sel Common : Tune	x x x	x x x	
System : Cloek Real Time : Commands	x x	x x	
Aux : Local ON/OFF : All Notes OFF Mes— : Active Sense sages : Reset	x x o x	x o (126,127) o x	

Notes : X 1 =transmit if trasmit channel is not off.
X 2 =receive if receive channel is not off.
X 3 =transmit/receive if Exclusive is not off.



Voice name : / /
Date : / /

[7] 39	ALGORITHM	OSCILLATOR	OP	1	2	3	4	5	6	[23] 55	Key mode	Foot control 1	
Algorithm		Mode								Key mode		[26] 58	FCI→CSI
Feedback		Coarse·Fine								Unison detune			PM depth
Osc key sync		Detune								[24] 56	Pitch bend		AM depth
Transpose		[9] 41 E G	OP	1	2	3	4	5	6	PBmode			EG-bias
[12] 44	L F O	Rate Scaling								Range			Volume
Wave		R1								Step		[26] 58	Foot control 2
Speed		R2								[24] 56	Portamento		PM depth
Delay		R3								Mode			AM depth
Mode		R4								Time			EG bias
Pmed sons [L+1, +2]		L1								Step			Volume
PM depth		L2								Random pitch		[26] 58	MIDI IN control
AM depth		L3								[25] 57	Modulation wheel		PM depth
Key sync		L4								PM depth			AM depth
[13] 45	Pitch E G	Output Level	OP	1	2	3	4	5	6	AM depth			EG-bias
Range		Scaling mode								EG-bias			Volume
Velocity		Output level								[25] 57	Breath control		
Scaling		Break point								PM depth			
R1		L-curve								AM depth			
R2		R-curve								EG-bias			
R3		L-depth								P-bias			
R4		R-depth								[25] 57	After touch		
L1		[11] Sensitivity	OP	1	2	3	4	5	6	PM depth			
L2		Key velocity								AM depth			
L3		A mod sens								EG-bias			
L4										P-bias			

Performance name :

Voice No.	
FS	
CSI	
CS2	
Total Volume	
EG Forced clamp	
Micro tuning	
Key shift	

MIDI DATA FORMAT

1. Transmission Requirements

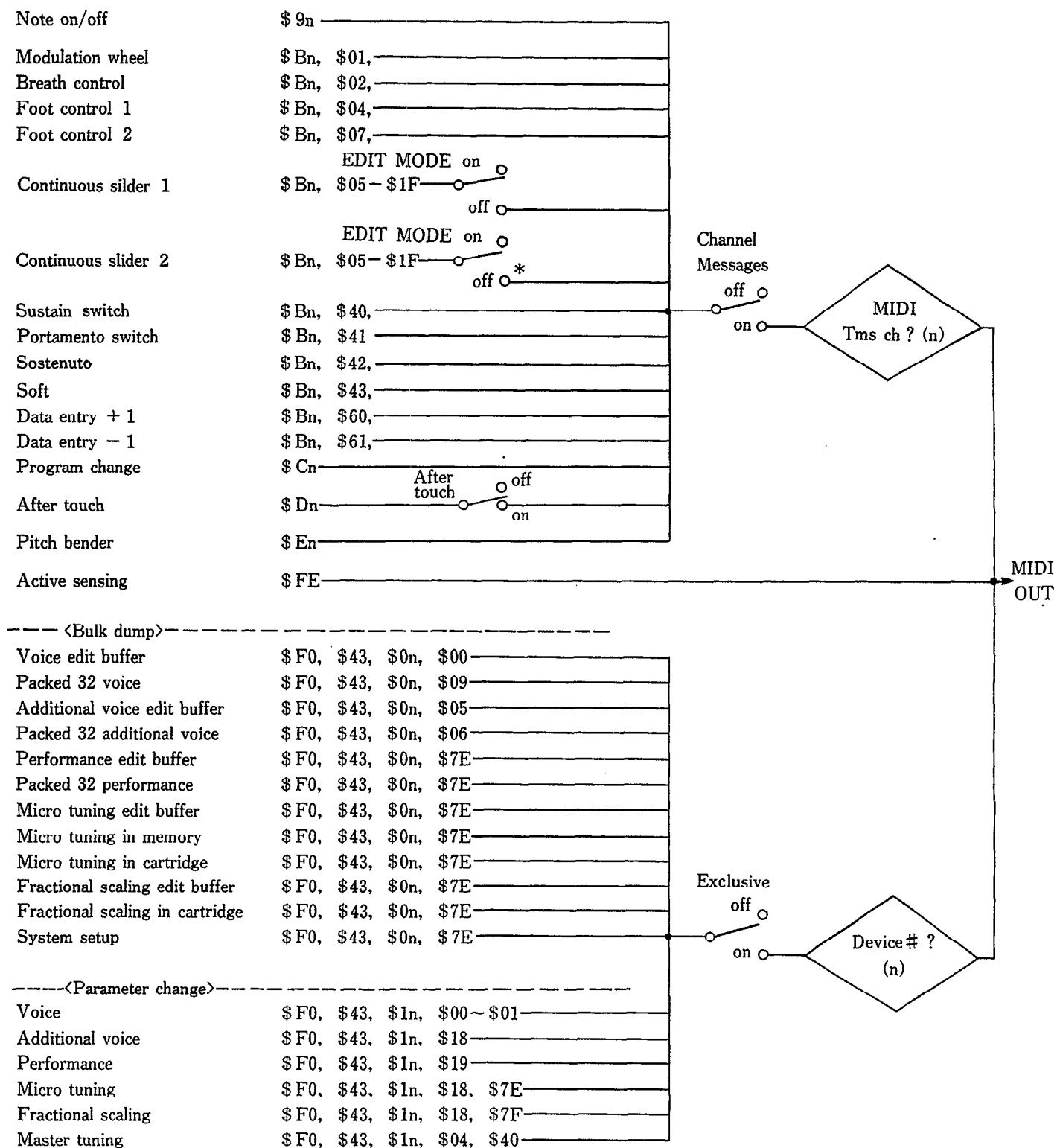

* PARAMETER CHANGE \$ 0, \$ 43, \$ 1n are output in EDIT MODE (ON).

2. Transmission Data

2-1. Channel information

Transmission is possible only when 1 ~ 16 is specified as the transmission channel.

1) Channel voice message

① Key ON/OFF

Status 1 0 0 1 n n n n (\$9n) n=channel No.
 Note No. 0 k k k k k k k k k k=36(C1)~96(C6)
 Velocity 0 v v v v v v v (v ≠ 0) Key ON
 0 0 0 0 0 0 0 0 (v ≠ 0) Key OFF

② Control change

Status 1 0 1 1 n n n n (\$Bn) n=channel No.
 Control No. 0 c c c c c c c
 Control Value 0 v v v v v v v

Control No.

c=1 Modulation wheel v=0~127
 c=2 Breath control v=0~127
 c=4 Foot control 1 v=0~127
 c=7 Foot control 2 v=0~127
 c=5~31 Continuous slider 1,2 v=0~127
 c=64 Sustain SW v=0: OFF, 127: ON
 c=65 Portamento SW v=0: OFF, 127: ON
 c=66 Sostenuato v=0: OFF, 127: ON
 c=67 soft v=0: OFF, 127: ON
 c=96 Data entry +1 v=0: OFF, 127: ON
 c-97 Data entry -1 v=0: OFF, 127: ON

③ Program change

Status 1 1 0 0 n n n n (\$Cn) n=channel No.
 Program No. 0 P P P P P P P p=0~127

④ After touch

Status 1 1 0 1 n n n n (\$Dn) n=channel No.
 Value 0 v v v v v v v v v=0~127

⑤ Pitch bender

Status 1 1 1 0 n n n n (\$En) n=channel No.
 Value (LSB) 0 u u u u u u u
 Value (MSB) 0 v v v v v v v

Resolution 7bit

The transmission data are as follows:

MSB			LSB			
0000	0000	(\$00)	0000	0000	(\$00)	Min.
0100	0000	(\$40)	0000	0000	(\$00)	Mid.
0111	1111	(\$7F)	0111	1110	(\$7E)	Max.

2-2. System information

1) System real time message

Active sensing
 Status 1 1 1 1 1 1 1 0 (\$FE)

2) System exclusive message

Transmission is possible only when the device No. is not set to OFF.

① Parameter change

Status 1 1 1 1 n n n n (\$F0)
 ID No. 0 1 0 0 0 0 1 1 (\$43)
 Substatus 0 0 0 1 n n n n (\$1n) n=device No.
 Group No. 0 g g g g g h h g=group No.
 h=sub group No.
 Parameter No. 0 p p p p p p p
 Data 0 d d d d d d d } Single or multiple
 0 d d d d d d d } bytes
 EOX 1 1 1 1 0 1 1 1 (\$F7)

There are seven parameter group Nos. and parameter Nos.

Parameter	g	h	p	No. of data byte
Voice	0	0	0~127	1
	0	1	0~30	1
Additional voice Note 3)	6	0	0~73	1
Performance	6	1	0~52	1
Master tuning	1	0	64	1
Micro tuning	6	0	126	3 Note 1)
Fractional scaling	6	0	127	4 Note 2)

Note 1) Data bytes

0 k k k k k k k k key number 0-127 binary total of
 0 h h h h h h h h data (high) 0-84 binary 3 bytes
 0 1 1 1 1 1 1 1 data (low) 0-127 binary

Note 2) Data bytes

0 0 0 0 0 p p p operator number 0-5 binary
 0 0 k k k k k k k key group number 0-127 binary total of
 0 h h h h h h h h data (high) 0-1 binary 4 byte
 0 1 1 1 1 1 1 1 data (low) 0-127 binary

Note 3) Under the Supplement parameter change, DX7 function parameter change will be transmitted along with the above.

Note 4) Fractional Scaling Parameter Change Data

Operator number

P	operator
0	OP6
1	OP5
2	OP4
3	OP3
4	OP2
5	OP1

Note 5) Fractional Scaling Parameter Change Data

K	key group	data
0	offset	-128~+127
1	C-2 ~C-1	+0~+255
2	C#-1~D#-1	+0~+255
3	E-1 ~F#-1	+0~+255
4	G-1 ~A-1	+0~+255
5	A#-1~C0	+0~+255
6	C#0 ~D#0	+0~+255
7	E0 ~F#0	+0~+255
8	G0 ~A0	+0~+255
9	A#0 ~C1	+0~+255
10	C#1 ~D#1	+0~+255
11	E1 ~F#1	+0~+255
12	G1 ~A1	+0~+255
13	A#1 ~C2	+0~+255
14	C#2 ~D#2	+0~+255
15	E2 ~F#2	+0~+255
16	G2 ~A2	+0~+255
17	A#2 ~G3	+0~+255
18	C#3 ~D#3	+0~+255
19	E3 ~F#3	+0~+255
20	G3 ~A3	+0~+255
21	A#3 ~C4	+0~+255
22	C#4 ~D#4	+0~+255
23	E4 ~F#4	+0~+255
24	G4 ~A4	+0~+255
25	A#4 ~C5	+0~+255
26	C#5 ~D#5	+0~+255
27	E5 ~F#5	+0~+255
28	G5 ~A5	+0~+255
29	A#5 ~C6	+0~+255
30	C#6 ~D#6	+0~+255
31	E6 ~F#6	+0~+255
32	G6 ~A6	+0~+255
33	A#6 ~C7	+0~+255
34	C~7 ~D#7	+0~+255
35	E7 ~F#7	+0~+255
36	G7 ~A7	+0~+255
37	A#7 ~C8	+0~+255
38	C#8 ~D#8	+0~+255
39	E8 ~F#8	+0~+255
40	G8	+0~+255

② Bulk dump

```

For [
  Voice edit buffer
  Additional voice edit buffer
  Packed 32 additional voice
  Packed 32 voice
]
Status      1 1 1 1 n n n n ($F0)
ID No.      0 1 0 0 0 0 1 1 ($43)
Substatus   0 0 0 0 n n n n ($0n) n=device No.
Group No.   0 f f f f f f f f f=format No.
Byte count (MSB) 0 b b b b b b b b
Byte count (LSB) 0 b b b b b b b b
Data        0 d d d d d d d d
           ↓
           0 d d d d d d d d
Checksum    0 e e e e e e e e
EOX         1 1 1 1 0 1 1 1 ($F7)
  
```

There are 4 format numbers as follows.

Data	Format No.	Byte count
Voice edit buffer	0	155
Additional voice edit buffer	5	49
Packed 32 voice	9	4096
Packed 32 additional voice	6	1120

There 8 types of format as follows:

Data	Byte count	Classification name	Data format name	No. of repeats
Performance edit buffer	61	LM__	8973PE	1
Packed 32 performance	1642	LM__	8973PM	1
System setup	95	LM__	8973S _	1
Micro tuning edit buffer	266	LM__	MCRYE _	1
Micro tuning with memory #x	266	LM__	MCRYMx	1
Micro tuning in cartridge	266	LM__	MCRYC _	63
Fractional scaling edit buffer	502	LM__	FKSYE _	1
Fractional scaling in cartridge	502	LM__	FKSYC _	32

Note 1) The x of MCRYMx is a memory No. expressed in binary form, 0 or 1.

Note 2) When the number of repeats is 64, the data group from byte count to checksum will be transmitted 64 times.

Note 3) Fractional scaling data is converted into P-byte ASCII codes by adding parameter \$30, after assigning data from 0 to 255 to the upper 4 bits and to the lower 4 bits.

• When using universal Bulk Dump

```

For [
  Performance edit buffer
  Packed 32 performance
  System setup
  Micro tuning edit buffer
  Micro tuning with memory number
  Micro tuning in cartridge
  Fractional scaling edit buffer
  Fractional scaling in cartridge
]
Status      1 1 1 1 n n n n ($F0)
ID No.      0 1 0 0 0 0 1 1 ($43)
Substatus   0 0 0 0 n n n n ($0n) n=device No.
Group No.   0 1 1 1 1 1 1 0 ($7E)
Byte count (MSB) 0 b b b b b b b b
Byte count (LSB) 0 b b b b b b b b
Classification 0 a a a a a a a a ASCII'L
name          0 a a a a a a a a 'M
              0 a a a a a a a a ' _
              0 a a a a a a a a ' _
Data format   0 m m m m m m m m ASCII
name          ↓
Data          0 d d d d d d d d
              ↓
Checksum      0 e e e e e e e e
EOX           1 1 1 1 0 1 1 1 ($F7)
  
```

Repeat loop

3. Reception Requirements

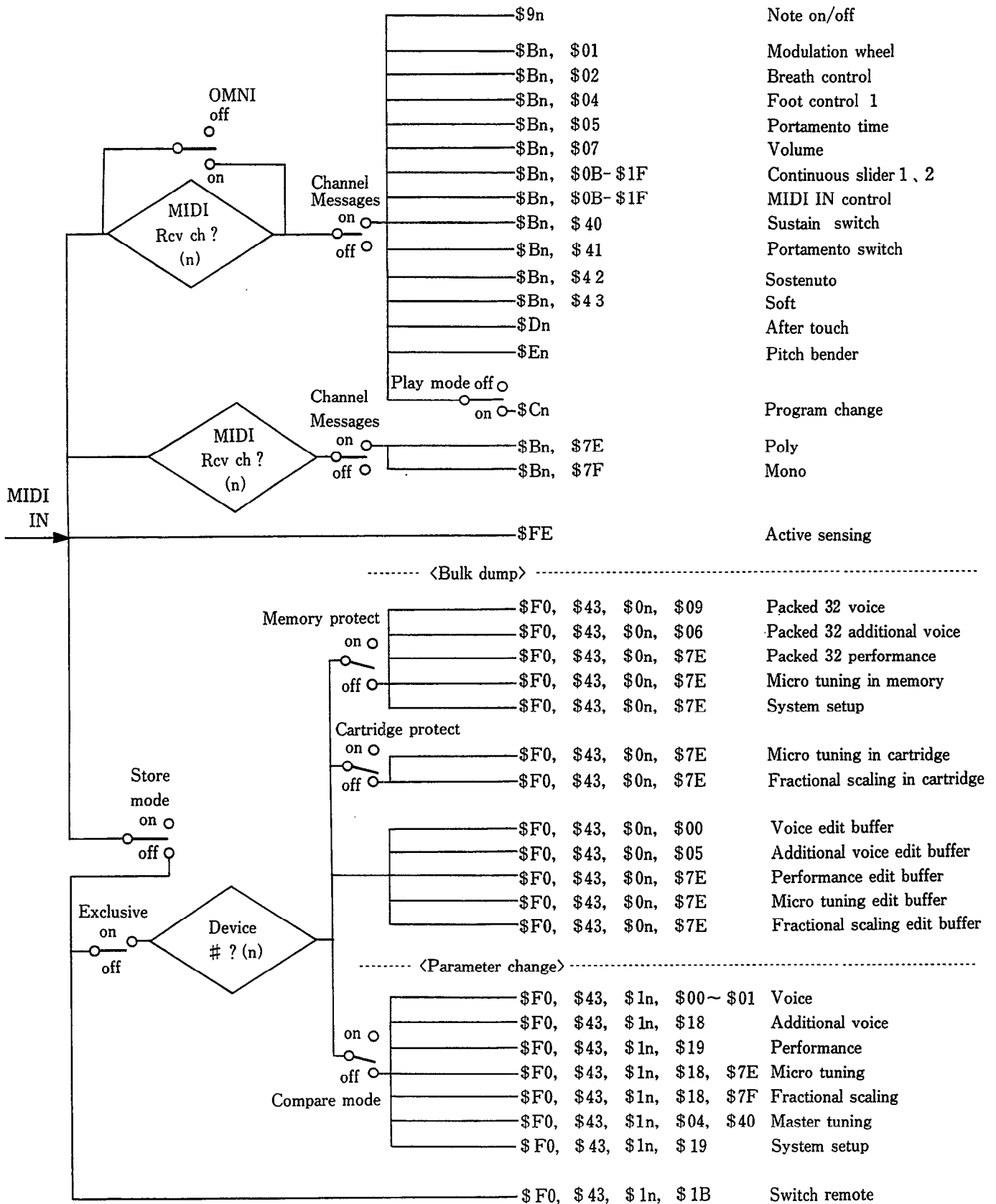

4. Reception Data

4-1. Channel information

1) Channel voice message

① Key OFF

Status 1 0 0 0 n n n n (\$8n) n=channel No.
 Note No. 0 k k k k k k k k k k=0 (C-2) ~ 127 (G8)
 Velocity 0 v v v v v v v v ignore v

② Key ON/OFF

Status 1 0 0 1 n n n n (\$9n) n=channel No.
 Note No: 0 k k k k k k k k k=0(C-2)~127(G8)
 Velocity 0 v v v v v v v v (v=0) Key ON
 0 0 0 0 0 0 0 0 (v=0) Key OFF

③ Control change

Status 1 0 1 1 n n n n (\$Bn) n=channel No.
 Control No. 0 c c c c c c c c
 Control Value 0 v v v v v v v v

Control No.

c=1 Modulation wheel v=0~127
 c=2 Breath control v=0~127
 c=4 Foot control 1 v=0~127
 c=5 Portamento time v=0~127
 c=7 Volume v=0~127
 c=11-31 Continuous slider 1,2 v=0~127
 c=11-31 MIDI IN control v=0~127
 c=64 Sustain SW v=0: OFF, 127: ON
 c=65 Portamento SW v=0: OFF, 127: ON
 c=66 Sostenuto v=0: OFF, 127: ON
 c=67 soft v=0: OFF, 127: ON

Note 1) The continuous sliders can be assigned to certain internal effects.

Note 2) MIDI IN control can be assigned in the same way as foot control 2.

④ Program change

Status 1 1 0 0 n n n n (\$Cn) n=channel No.
 Program No. 0 P P P P P P P P p=0~127

0~31 select internal PERFORMANCE combinations in PERFORMANCE mode.

32~63 select cartridge PERFORMANCE combinations. Values over 64 repeat this order of selection (INT 1~32 → CRT 1~32).

In voice mode, 0~63 select INT voices, 64-127 CRT voices.

⑤ .After touch

Status 1 1 0 1 n n n n (\$Dn) n=channel No.
 Value 0 v v v v v v v v v=0~127

⑥ IPitch bender

Status 1 1 1 0 n n n n (\$En) n=channel No.
 Value (LSB) 0 u u u u u u u u
 Value (MSB) 0 v v v v v v v v

Operates with only the MSB data.

M S B			
0000	0000	(\$00)	Min.
0100	0000	(\$40)	Mid.
0111	1111	(\$7F)	Max.

2) Channel mode message

① POLY/All note off

Status 1 0 1 1 n n n n (\$Bn) n=channel No.
 Control No. 0 1 1 1 1 1 1 1 0 (\$7E)
 Control value 0 0 0 0 0 0 0 0

② MONO/All note off

Status 1 0 1 1 n n n n (\$Bn) n=channel No.
 Control No. 0 1 1 1 1 1 1 1 1 (\$7F)
 Control value 0 m m m m m m m m Set to the Mono mode with only m=1. recognized. ignore when m=1.

4-2. System information

1) System real time messages

① Active sensing

Status 1 1 1 1 1 1 1 0 (\$FE)

Upon reception of the code, sensing will start. When there is no status byte or data for 300 msec, the MIDI reception buffer is cleared and the on-going sound turned OFF.

As far as AFTER TOUCH/MIDI IN CONTROL=0, BREATH CONTROL/FOOT CONTROL/MODULATION WHEEL is concerned, its element value is assigned.

Reception is enabled regardless of the Device Number. All the switches on the panel can be controlled. The numbers are assigned to the switches as follows:

2) System exclusive messages

① Parameter change (Switch remote)

Status 1 1 1 1 n n n n (\$F0)
 ID No. 0 1 0 0 0 0 1 1 (\$43)
 Substatus 0 0 0 1 n n n n (\$1n) n=device No.
 Group No. 0 0 0 1 1 0 1 1 (\$1B)
 Parameter No. 0 P P P P P P P p=switch number
 (0~45)
 Data 0 d d d d d d d d=0: OFF
 d=127: ON
 EOX 1 1 1 1 0 1 1 1 (\$F7)

All the panel switches are controlled.
 The switch numbers are follows:

38	39	32	33	34	0	1	2	3	4	5	6	7	8	9	10	11	12	13	14	15
40	41	35	36	37	16	17	18	19	20	21	22	23	24	25	26	27	28	29	30	31

② Parameter change system reset

Status 1 1 1 1 n n n n (\$F0)
 ID No. 0 1 0 0 0 0 1 1 (\$43)
 Substatus 0 0 0 1 n n n n (\$1n) n=device No.
 Group No. 0 0 0 1 1 0 1 1 (\$1B)
 Parameter No. 0 0 1 0 1 1 1 0 (\$2E)
 Data 0 d d d d d d d Ignore d value
 EOX 1 1 1 1 0 1 1 1 (\$F7)

Reception is enabled regardless of the Device Number.
 Upon reception of this code, operation will be carried out
 as if the power is just turned on.

③ Parameter change system setup

Status 1 1 1 1 n n n n (\$F0)
 ID No. 0 1 0 0 0 0 1 1 (\$43)
 Substatus 0 0 0 1 n n n n (\$1n) n=device No.
 Group No. 0 0 0 1 1 0 0 1 (\$19)
 Parameter No. 0 P P P P P P P p=parameter No.
 (64-84)
 Data 0 d d d d d d d d=0: OFF
 d=127: ON
 EOX 1 1 1 1 0 1 1 1 (\$F7)

Upon reception of this code, the corresponding parameter
 is changed. However, the change is not in effect if the
 parameter stays displayed in the LCD.

④ Parameter change

Status 1 1 1 1 n n n n (\$F0)
 ID No. 0 1 0 0 0 0 1 1 (\$43)
 Substatus 0 0 0 1 n n n n (\$1n) n=device No.
 Group No. 0 g g g g g h h g=group No.
 h=sub group No.
 Parameter No. 0 P P P P P P P
 Data 0 d d d d d d d single or multiple
 0 d d d d d d d bytes
 EOX 1 1 1 1 0 1 1 1 (\$F7)

Upon reception, the EDIT MODE will be forced to activated.
 The parameter group number and parameter number for the
 6 parameters are as follows:

Parameter	g	h	P	No. of data byte
Voice	0	0	0~127	1
	0	1	0~30	1
Additional voice	6	0	0~73	1
Performance	6	1	0~52	1
Master tuning	1	0	64	1
Micro tuning	6	0	126	3
Fractional scaling	6	0	127	4

⑤ Bulk dump

Same as in transmission.

⑥ Universal bulk dump

Same as in transmission.

⑦ Dump request

For { Voice edit buffer (f=0)
 Additional voice edit buffer (f=5)
 Packed 32 voice (f=9)
 Packed 32 additional voice (f=6)

Status 1 1 1 1 n n n n (\$F0)
 ID No. 0 1 0 0 0 0 1 1 (\$43)
 Substatus 0 0 1 0 n n n n (\$2n) n=device No.
 Group No. 0 f f f f f f f f=format No.
 (0, 5, 6, 9)
 EOX 1 1 1 1 0 1 1 1 (\$F7)

⑧ Universal bulk dump request

Status 1 1 1 1 n n n n (\$F0)
 ID No. 0 1 0 0 0 0 1 1 (\$43)
 Substatus 0 0 1 0 n n n n (\$2n) n=device No.
 Group No. 0 1 1 1 1 1 1 0 (\$7E)
 Clasification name 0 a a a a a a a ASCII 'L'
 0 a a a a a a a ASCII 'M'
 0 a a a a a a a ASCII '—'
 0 a a a a a a a ASCII '—'
 Data format name 0 m m m m m m ASCII
 ↓
 0 m m m m m m
 EOX 1 1 1 1 0 1 1 1 (\$F7)

The 8 types of format are as follows:

Data	Classification name	Data format name
Performance edit buffer	LM_ _	8973PE
Packed 32 performance	LM_ _	8973PM
System setup	LM_ _	8973S_
Micro tuning edit buffer	LM__	MCRYE
Micro tuning with memory	LM_ _	MCRYMx
Micro ro tuning in cartridge	LM_ _	MRCYC_
Fractional scaling edit buffer	LM_ _	FFKSYE_
Fractional scaling in cartridge	LM_ _	FKSYC_

5. PARAMETER CHART

5-1. VOICE PARAMETER (Voice edit buffer)

g	h	PARAMETER NUMBER						DATA	(INIT)	PARAMETER
		6	5	4	3	2	1			
0	0	0	21	42	63	84	105	0-99	(99)	EG RATE1
		1	22	43	64	85	106	0-99	(99)	EG RATE2
		2	23	44	65	86	107	0-99	(99)	EG RATE3
		3	24	45	66	87	108	0-99	(99)	EG RATE4
		4	25	46	67	88	109	0-99	(99)	EG LEVEL1
		5	26	47	68	89	110	0-99	(99)	EG LEVEL2
		6	27	48	69	90	111	0-99	(99)	EG LEVEL3
		7	28	49	70	91	112	0-99	(0)	EG LEVEL4
		8	29	50	71	92	113	0-99	(C3)	BREAK POINT
		9	30	51	72	93	114	0-99	(0)	LEFT DEPTH
		10	31	52	73	94	115	0-99	(0)	RIGHT DEPTH
		11	32	53	74	95	116	0-3	(-LIN)	LEFT CURVE
		12	33	54	75	96	117	0-3	(-LIN)	RIGHT CURVE
		13	34	55	76	97	118	0-7	(0)	RATE SCALING
		14	35	56	77	98	119	0-3	(0)	MODULATION SENSITIVITY
		15	36	57	78	99	120	0-7	(0)	TOUCH SENSITIVITY
		16	37	58	79	100	121	0-99	(0, OP1:99)	TOTALLEVEL
		17	38	59	80	101	122	0-1	(RATIO)	FREQUENCY MODE
		18	39	60	81	102	123	0-31	(1)	FREQUENCY COARSE
		19	40	61	82	103	124	0-99	(0)	FREQUENCY FINE
20	41	62	83	104	125	0-14	(7)	DETUNE		
0	1	126						0-99	(99)	PEG RATE1
		127						0-99	(99)	PEG RATE2
		0						0-99	(99)	PEG RATE3
		1						0-99	(99)	PEG RATE4
		2						0-99	(50)	PEG LEVEL1
		3						0-99	(50)	PEG LEVEL2
		4						0-99	(50)	PEG LEVEL3
		5						0-99	(50)	PEG LEVEL4
		6						0-31	(ALG1)	ALGORITHM SELECTOR
		7						0-7	(0)	FEED BACK LEVEL
		8						0-1	(ON)	OSC. SYNC
		9						0-99	(35)	LFO SPEED
		10						0-99	(0)	LFO DELAY TIME
		11						0-99	(0)	PITCH MODULATION DEPTH
		12						0-99	(0)	AMPLITUDE MODULATION DEPTH
		13						0-1	(ON)	LFO KEY SYNC
		14						0-5	(TRI)	LFO WAVE
		15						0-7	(3)	LFO PITCH MODULATION SENSE
		16						0-48	(C3)	TRANSPOSE
		17						ASCII	(I)	VOICE NAME
		18						ASCII	(N)	VOICE NAME
		19						ASCII	(I)	VOICE NAME
		20						ASCII	(T)	VOICE NAME
		21						ASCII	()	VOICE NAME
		22						ASCII	(V)	VOICE NAME
		23						ASCII	(O)	VOICE NAME
		24						ASCII	(I)	VOICE NAME
		25						ASCII	(C)	VOICE NAME
26						ASCII	(E)	VOICE NAME		
27						0-63	(ALL ON)	OPERATOR ENABLE B5:OP1,-,B0:OP6		
28						0-5		OPERATOR SELECT 0:OP6,-,5:OP1		

5-2. ADDITIONAL VOICE PARAMETER (ADDITIONAL VOICE EDIT BUFFER)

g	h	P.NO	DATA (INIT)	PARAMETER
6	0	0	0 - 1 (norm)	OP6 scaling mode normal/fractional
		1	0 - 1 (norm)	OP5 scaling mode normal/fractional
		2	0 - 1 (norm)	OP4 scaling mode normal/fractional
		3	0 - 1 (norm)	OP3 scaling mode normal/fractional
		4	0 - 1 (norm)	OP2 scaling mode normal/fractional
		5	0 - 1 (norm)	OP1 scaling mode normal/fractional
		6	0 - 7 (0)	OP6 amplitude modulation sensitivity
		7	0 - 7 (0)	OP5 amplitude modulation sensitivity
		8	0 - 7 (0)	OP4 amplitude modulation sensitivity
		9	0 - 7 (0)	OP3 amplitude modulation sensitivity
		10	0 - 7 (0)	OP2 amplitude modulation sensitivity
		11	0 - 7 (0)	OP1 amplitude modulation sensitivity
		12	0 - 3 (8oct)	pitch EG range 8oct, 4oct, 1oct, 1/2oct
		13	0 - 1 (singl)	LFO key trigger (delay) single/multi
		14	0 - 1 (off	pitch EG by velocity switch off/on: 0/1
		15	0 - 3 (poly)	bit0; poly/mono, bit1; unison off/on
		16	0 - 12 (2)	pitch bend range
		17	0 - 12 (0)	step
		18	0 - 3 (norm)	mode normal/low/high/key on
		19	0 - 7 (0)	random pitch depth off/+ -3.5c to + -45.4c at C3
		20	0 - 1 (rtn)	portamento mode retain/follow fingerd/fulltime
		21	0 - 12 (0)	step
		22	0 - 99 (0)	time
		23	0 - 99 (0)	modulation wheel pitch modulation range
		24	0 - 99 (0)	amplitude modulation range
		25	0 - 99 (0)	EG bias range
		26	0 - 99 (0)	foot control 1 pitch modulation range
		27	0 - 99 (0)	amplitude modulation range
		28	0 - 99 (0)	EG bias range
		29	0 - 99 (0)	volume range
		30	0 - 99 (0)	breath control pitch modulation range
		31	0 - 99 (0)	amplitude modulation range
		32	0 - 99 (0)	EG bias range
		33	0 - 100 (50)	pitch bias range
		34	0 - 99 (0)	after touch pitch modulation range
		35	0 - 99 (0)	amplitude modulation range
		36	0 - 99 (0)	EG bias range
		37	0 - 100 (50)	pitch bias range
		38	0 - 7 (0)	pitch EG rate scaling depth
		39-63		reserved
		64	0 - 99 (0)	foot control 2 pitch modulation range
		65	0 - 99 (0)	amp modulation range
		66	0 - 99 (0)	EG bias range
		67	0 - 99 (0)	volume range
		68	0 - 99 (0)	MIDI IN control pitch modulation range
		69	0 - 99 (0)	amp modulation range
		70	0 - 99 (0)	EG bias range
		71	0 - 99 (0)	volume range
		72	0 - 7 (0)	unison detune depth
		73	0 - 1 (0)	foot control 1 use as CS1 switch off/on: 0/1

**5-3. PERFORMACNCE PARAMETER
(PERFORMANCE EDIT BUFFER /1 PERFORMANCE MEMORY)**

g	h	P.NO	DATA (INIT)	PARAMETER
6	1	0	0	SINGLE
		1	0- 127 (0)	A-CH VOICE NUMBER
		2	0- 127 (0)	B-CH VOICE NUMBER
		3	0- 74 (EQUAL)	MICRO TUNING TABLE SELECT
		4	0- 11 ({C})	MICRO TUNING KEY
		5		MICRO TUNING SWITCH BIT0: A, BIT1: B0/1: OFF/ON
		6	0- 7 (0)	DUAL DETUNE DEPTH
		7	0- 127 (C3)	SPLIT POINT
		8	0- 1 (OFF)	EG FORCED DAMP SWITCH O/1: OFF/ON
		9		SUSTAIN FOOT SWITCH BIT0: A, BIT1:B, 0/1: OFF/ON
		10	0- 3 (PORT)	FOOT SWITCH ASSIGN 0: SUS, 1: PORT, 2: SOSTENUTO, 3: SOFT
		11		FOOT SWITCH BIT0: A, BIT1: B0/1: OFF/ON
		12	0- 7 (0)	SOFT PEDAL RANGE
		13	0- 48 (0)	NOTE SHIFT RANGE FOR SINGLE, DUAL, SPLIT (A)
		14	0- 48 (0)	NOTE SHIFT RANGE FOR SPLIT (B)
		15	0- 100 (CENTER)	VOLUME BALANCE (-50 ~ + 50)
		16	0- 99 (99)	TOTAL VOLUME
		17	0- 105 (NO EFC)	CONTINUOUS SLIDER 1
		18	0- 105 (NO EFC)	CONTINUOUS SLIDER 2 b2: CS2A, b3: CS2B
		19	5	CONTINUOUS SLIDER, ASSIGN SWITCH b0: CS1A, b1: CS1B, A: ON CS1/2
		20	0- 3 (ON-ON)	PAN MODE 0: MIX, 1: ON-ON, 2: ON-OFF, 3: OFF-ON
		21	0- 99 (0)	PAN CONTROLL RANGE
		22	0- 2 (LFO)	PAN CONTROLL ASSIGN 0/1/2: LFO/VELOCITY/KEY No.
		23	0- 99 (99)	PAN EG RATE 1
		24	0- 99 (99)	PAN EG RATE 2
		25	0- 99 (99)	PAN EG RATE 3
		26	0- 99 (99)	PAN EG RATE 4
		27	0- 99 (50)	PAN EG LEVEL 1
		28	0- 99 (50)	PAN EG LEVEL 2
		29	0- 99 (50)	PAN EG LEVEL 3
		30	0- 99 (50)	PAN EG LEVEL 4
		31	ASCII (I)	PERFORMANCE NAME
		32	(N)	
		33	(I)	
		34	(T)	
		35	()	
		36	(P)	
		37	(E)	
		38	(R)	
		39	(F)	
		50	()	

5-4. VOICE MEMORY FORMAT

NO						BIT6	BIT5	BIT4	BIT3	BIT2	BIT1	BIT0
OP6	OP5	OP4	OP3	OP2	OP1	PARAMETER						
0	17	34	51	68	85							EG RATE1
1	18	35	52	69	86							EG RATE2
2	19	36	53	70	87							EG RATE3
3	20	37	54	71	88							EG RATE4
4	21	38	55	72	89							EG LEVEL1
5	22	39	56	73	90							EG LEVEL2
6	23	40	57	74	91							EG LEVEL3
7	24	41	58	75	92							EG LEVEL4
8	25	42	59	76	93							BREAK POINT
9	26	43	60	77	94							LEFT DEPTH
10	27	44	61	78	95							RIGHT DEPTH
11	28	45	62	79	96	-		-		-		RIGHT CURVE
12	29	46	63	80	97			DETUNE				RATE SCALING
13	30	47	64	81	98	-		-				TOUCH SENSITIVITY
14	31	48	65	82	99							A.MOD SENS.
15	32	49	66	83	100	-						TOTAL LEVEL
16	33	50	67	84	101							FREQ. COARSE
												F.MODE
												FREQ. FINE
.....												
102												PEG RATE1
103												PEG RATE2
104												PEG RATE3
105												PEG RATE4
106												PEG LEVEL1
107												PEG LEVEL2
108												PEG LEVEL3
109												PEG LEVEL4
110						-		-				ALGORITHM SELECT
111						-		-		-		OSC.SNC
112												FEED BACK LEVEL
113												LFO SPEED
114												LFO DELAY TIME
115												LFO MODE
116												LFO A.MOD DEPTH
117						LFO P.MOD SENS.						LFO WAVE
118												KEY SNC
119												TRANSPOSE
120												VOICE NAME1
121												VOICE NAME2
122												VOICE NAME3
123												VOICE NAME4
124												VOICE NAME5
125												VOICE NAME6
126												VOICE NAME7
127												VOICE NAME8
128												VOICE NAME9
129												VOICE NAME10

5-5. ADDITIONAL VOICE MEMORY

NO	BIT6	BIT5	BIT4	BIT3	BIT2	BIT1	BIT0	
0	-	OP1	OP2	OP3	OP4	OP5	OP6	SCALING MODE
1	-		OP5			OP6		A.MOD SENSE.
2	-		OP3			OP4		A.MOD SENSE.
3	-		OP1			OP2		A.MOD SENSE.
4	RANDOM	PITCH DEPTH		PEG SW	LFO TRG	PEG RANGE		
5	-		PB RANGE			P MOD SENS.		
6	-	PB MODE			PB STEP			
7	-	-	PORT. STEP				PRT.MODE	
8			PORT. TIME					
9			MW PMOD					
10			MW AMOD					
11			MW EG BIAS					
12			FC1 PMOD					
13			FC1 AMOD					
14			FC1 EG BIAS					
15			FC1 VOLUME					
16			BC PMOD					
17			BC AMOD					
18			BC EG BIAS					
19			BC PITCH BIAS					
20			AT PMOD					
21			AT AMOD					
22			AT EC BIAS					
23			AT PITCH BIAS					
24					PEG RATE SCALING			
25					RESERVED			
<hr/>								
26			FC2 PMOD					
27			FC2 AMOD					
28			FC2 EG BIAS					
29			FC2 VOLUME					
30			MIDI IN CONTROL PMOD					
31			MIDI IN CONTROL AMOD					
32			MIDI IN CONTROL EG BIAS					
33			MIDI IN CONTROL VOLUME					
34				FCCS1SW	UNISON DETUNE			

5-6. SYSTEM SETUP PARAMETER

g	h	P.NO	DATA (INIT)	PARAMETER
6	1	64	0- 15 (0)	MIDI TX channel
		65	0- 1 (0N)	MIDI channel voice message TRANS switch
		66	0- 16 (0)	MIDI RX channel 16: off
		67	0- 16 (0)	MIDI RX channel 16: off
		68	0- 1 (0N)	MIDI OMNI MODE SWITCH O/I: OFF/ON
		69	9- 31 (11)	MIDI CONTROLER NUMBER
		70	9- 31 (12)	MIDI CONTROLER NUMBER
		71	5- 31 (13)	CONTINUOUS SLIDER 1 CONTROLL NUMBER
		72	5- 31 (14)	CONTINUOUS SLIDER 2 CONTROLL NUMBER
		73	0- 2 (NORMAL)	MIDI key on/off normal/odd/even: 0/1/2 flag
		74	0- 2 (NORMAL)	PROGRAM CHANGE TRANS MODE FLAG 0/1/2: of/nor/prg
		75	0- 1 (0N)	LOCAL SWITCH 0/1: OFF/ON
		76	0- 1 (1-32)	MIDI transmit block flag
		77	0- 1 (1-32)	MIDI receive block flag
		78	0- 15 (0)	MIDI system common message RX channel (device No.)
		79	0- 1 (0N)	MIDI system common message switch
		80	0- 15 (0)	cartridge appoint bank number for voice&performance
		81	0- 15 (2)	cartridge appoint bank number for fractional scaling
		82	0- 15 (3)	cartridge appoint bank number for micro tuning
		83*1	0- 3 (ON/ON)	memory protect b0: int, bl; crt
		1	0	64
-*2	0-127 (SW. NO.)			programmable program change trans set buffer (64 bytes)

* 1 be not included in bulk data (only parameter change)
In bulk format, this parameter area is reserved. (dummy byte)

* 2 be included in bulk data only (does not have parameter change code)

5-7. MICRO TUNING PARAMETER

BYTE	KEYNAME						DATA	NOTES
0	C-2	48 C0	96 C2	144 C4	192 C6	240 C8	0-84	MSB
1	C-2	49	97	145	193	241	0-127 0-10794	LSB
2		50	98	146	194	242		MSB
3	C#-2	51	99	147	195	243	0-127 0-10794	LSB
4	D-2	52	100	148	196	244	0-84	MSB
5	D-2	53	101	149	197	245	0-127 0-10794	LSB
6		54	102	150	198	246		MSB
7		55	103	151	199	247	0-127 0-10794	LSB
8	E-2	56	104	152	200	248	0-84	MSB
9	E-2	57	105	153	201	249	0-127 0-10794	LSB
10	F-2	58	106	154	202	250	0-84	MSB
11	F-2	59	107	155	203	251	0-127 0-10794	LSB
12		60	108	156	204	252		MSB
13		61	109	157	205	253	0-127 0-10794	LSB
14	G-2	62	110	158	206	254	0-84	MSB
15	G-2	63	111	159	207	255	0-127 0-10794	LSB
16	G#-2	64	112	160	208		0-84	MSB
17	G#-2	65	113	161	209		0-127 0-10794	LSB
18	A-2	66	114	162	210			MSB
19		67	115	163	211		0-127 0-10794	LSB
20		68	116	164	212		0-84	MSB
21	A#-2	69	117	165	213		0-127 0-10794	LSB
22	B-2	70	118	166	214		0-84	MSB
23	B-2	71	119	167	215		0-127 0-10794	LSB
24	C-1	72 C1	120 C3	168 C5	216 C7			
25		73	121	169	217			
26		74	122	170	218			
27		75	123	171	219			
28		76	124	172	220			
29		77	125	173	221			
30		78	126	174	222			
31		79	127	175	223			
32		80	128	176	224			
33		81	129	177	225			
34		82	130	178	226			
35		83	131	179	227			
36		84	132	180	228			
37		85	133	181	229			
38		86	134	182	230			
39		87	135	183	231			
40		88	136	184	232			
41		89	137	185	233			
42		90	138	186	234			
43		91	139	187	235			
44		92	140	188	236			
45		93	141	189	237			
46		94	142	190	238			
47		95	143	191	239			

5-8. FRACTIONAL KEY LEVEL SCALING PARAMETER

	OP6	OP5	OP4	OP3	OP2	OP1	DATA
OFS	0	41	82	123	164	205	-127 ~ +127
C-2 - C-1	1	42	83	124	165	206	0 ~ 255
C#-1 - D#-1	2	43	84	125	166	207	0 ~ 255
E-1 - F#-1	3	44	85	126	167	208	0 ~ 255
G-1 - A-1	4	45	86	127	168	209	0 ~ 255
A#-1 - C0	5	46	87	128	169	210	0 ~ 255
C#0 - D#0	6	47	88	129	170	211	0 ~ 255
E0 - F#0	7	48	89	130	171	212	0 ~ 255
G0 - A0	8	49	90	131	172	213	0 ~ 255
A#0 - C1	9	50	91	132	173	214	0 ~ 255
C#1 - D#1	10	51	92	133	174	215	0 ~ 255
E1 - F#1	11	52	93	134	175	216	0 ~ 255
G1 - A1	12	53	94	135	176	217	0 ~ 255
A#1 - C2	13	54	95	136	177	218	0 ~ 255
C#2 - D#2	14	55	96	137	178	219	0 ~ 255
E2 - F#2	15	56	97	138	179	220	0 ~ 255
G2 - A2	16	57	98	139	180	221	0 ~ 255
A#2 - C3	17	58	99	140	181	222	0 ~ 255
C#3 - D#3	18	59	100	141	182	223	0 ~ 255
E3 - F#3	19	60	101	142	183	224	0 ~ 255
G3 - A3	20	61	102	143	184	225	0 ~ 255
A#3 - C4	21	62	103	144	185	226	0 ~ 255
C#4 - D#4	22	63	104	145	186	227	0 ~ 255
E4 - F#4	23	64	105	146	187	228	0 ~ 255
G4 - A4	24	65	106	147	188	229	0 ~ 255
A#4 - C4	25	66	107	148	189	230	0 ~ 255
C#5 - D#5	26	67	108	149	190	231	0 ~ 255
E5 - F#5	27	68	109	150	191	232	0 ~ 255
G5 - A5	28	69	110	151	192	233	0 ~ 255
A#5 - C6	29	70	111	152	193	234	0 ~ 255
C#6 - D#6	30	71	112	153	194	235	0 ~ 255
E6 - F#6	31	72	113	154	195	236	0 ~ 255
G6 - A6	32	73	114	155	196	237	0 ~ 255
A#6 - C7	33	74	115	156	197	238	0 ~ 255
C#7 - D#7	34	75	116	157	198	239	0 ~ 255
E7 - F#7	35	76	117	158	199	240	0 ~ 255
G7 - A7	36	77	118	159	200	241	0 ~ 255
A#7 - C8	37	78	119	160	201	242	0 ~ 255
C#8 - D#8	38	79	120	161	202	243	0 ~ 255
E8 - F#8	39	80	121	162	203	244	0 ~ 255
G8	40	81	122	163	204	245	0 ~ 255

SPECIFICATIONS

- **Keyboard** 61 keys (C¹~C⁶), with Initial/After touch
- **Tone Generator** FM tone Generator (6 operators 32 algorithms)
- **Simultaneous Note Output (Reverse priority)**
 16 notes
- **Internal Memory** 64 voices/32 performances, 2 micro tunings, 1 system set-up
- **External ROM Memory**
 128 voices/64 performances, micro tuning, fractional level scaling, system set-up
- **External Memory** RAM cartridge (Optional, RAM4) = Internal Memory x 1, or 64 fractional level scaling or 63 micro tuning
- **Control Sliders and switches**
 Volume slider, Continuous sliders CS1, CS2 (Data entry)
 Data entry switch x 2, Mode setting switch x 12, Voice switch x 32
- **Controls** PITCH BEND WHEEL, MODULATION WHEEL
- **External Control Terminals**
 BREATH CONTROL, SUSTAIN, FOOT SWITCH (Sustain, Portamento, Key hold, Soft), FOOT CONTROL
 1 (Volume, Modulation, Voice parameter), FOOT CONTROL2 (Volume, Modulation).
 RAM&per.ROM CARTRIDGE SLOT
 MIDI IN — OUT — THRU
- **Output Terminals** Output Headphones
- **Display** LC: 40 letters x 2 lines (illuminated)
 LED: 7 segments x 2
- **Dimensions (W x H x D), Weight**
 999 x 85.8 x 333.7 mm, 10.5 kg
- **Power Supply, Power Consumption**
 U.S & Canadian Models: 120V, 50/60Hz
 General Model: 110V/220V/240V 50/80Hz
- **Standard Accessories**
 Music holder, ROM cartridge
- **Optional Accessories**
 RAM Cartridge RAM4
 Flight Case LC-7IIF
 Hard Case LC-7IIH
 Soft Case SC-7IIS
 Cartridge Adaptor ADP1

 Foot Switch FC4/FC5, Foot Controller FC7, Breath Controller BC1, Head Set Breath Controller BC2,
 Stand LG-100, MIDI Cable MIDI 01/03/15, Accessary KitADX20 (FC5, FC7, BC1), MIDI Data Filer (MDF1).

IMPORTANT SAFETY AND INSTALLATION INSTRUCTIONS

INFORMATION RELATING TO POSSIBLE PERSONAL INJURY, ELECTRIC SHOCK AND FIRE HAZARD POSSIBILITIES HAS BEEN INCLUDED IN THIS LIST.

WARNING – When using electronic products, basic precautions should always be followed, including the following:

1. Read all Safety and Installation Instructions, Supplemental Marking and Special Message Section data, and any applicable assembly instructions BEFORE using this product.
2. Check unit weight specifications BEFORE you attempt to move this product.
3. Main power supply verification. Yamaha Digital Musical Instrument products are manufactured specifically for use with the main supply voltage used in the area where they are to be sold. The main supply voltage required by these products is printed on the name plate. For name plate location please refer to the graphic in the Special Message section. If any doubt exists please contact the nearest Yamaha Digital Musical Instrument retailer.
4. Some Yamaha Digital Musical Instrument products utilize external power supplies or adapters. Do NOT connect products of this type to any power supply or adapter other than the type described in the owners manual or as marked on the unit.
5. This product may be equipped with a plug having three prongs or a polarized line plug (one blade wider than the other). If you are unable to insert the plug into the outlet, contact an electrician to have the obsolete outlet replaced. Do NOT defeat the safety purpose of the plug. Yamaha products not having three prong or polarized line plugs incorporate construction methods and designs that do not require line plug polarization.
6. **WARNING** – Do NOT place objects on the power cord or place the unit in a position where any one could walk on, trip over, or roll anything over cords of any kind. An improper installation of this type can create the possibility of a fire hazard and/or personal injury.
7. Environment: Your Yamaha Digital Musical Instrument should be installed away from heat sources such as heat registers and/or other products that produce heat.
8. Ventilation: This product should be installed or positioned in a way that its placement or location does not interfere with proper ventilation.
9. Yamaha Digital Musical Instrument products are frequently incorporated into “Systems” which are assembled on carts, stands or in racks. Utilize only those carts, stands, or racks that have been designed for this purpose and observe all safety precautions supplied with the products. Pay special attention to cautions that relate to proper assembly, heavier units being mounted at the lower levels, load limits, moving instructions, maximum usable height and ventilation.
10. Yamaha Digital Musical Instrument products, either alone or in combination with amplification, headphones, or speakers, may be capable of producing sound levels that could cause permanent hearing loss. Do NOT operate at high volume levels or at a level that is uncomfortable. If you experience any discomfort, ringing in the ears, or suspect any hearing loss, you should consult an audiologist.
11. Do NOT use this product near water or in wet environments. For example, near a swimming pool, spa, in the rain, or in a wet basement.
12. Care should be taken so that objects do not fall, and liquids are not spilled into the enclosure.
13. Yamaha Digital Musical Instrument products should be serviced by a qualified service person when:
 - a. The power supply/power adapter cord or plug has been damaged; or
 - b. Objects have fallen, or liquid has been spilled into the products; or
 - c. The unit has been exposed to rain; or
 - d. The product does not operate, exhibits a marked change in performance; or
 - e. The product has been dropped, or the enclosure of the product has been damaged.
14. When not in use, always turn your Yamaha Digital Musical Instrument equipment “OFF”. The power supply cord should be unplugged from the outlet when the equipment is to be left unused for a long period of time. NOTE: In this case, some units may lose some user programmed data. Factory programmed memories will not be affected.
15. Electromagnetic Interference (RFI). Yamaha Digital Musical Instruments utilize digital (high frequency pulse) technology that may adversely affect Radio/TV reception. Please read FCC Information (back cover) for additional information.
16. Do NOT attempt to service this product beyond that described in the user maintenance section of the owners manual. All other servicing should be referred to qualified service personnel.

**PLEASE KEEP THIS MANUAL
FOR FUTURE REFERENCE!**

FCC INFORMATION

While the following statements are provided to comply with FCC Regulations in the United States, the corrective measures listed below are applicable worldwide.

This series of Yamaha professional music equipment uses frequencies that appear in the radio frequency range and if installed in the immediate proximity of some types of audio or video devices (within three meters), interference may occur. This series of Yamaha combo equipment have been type tested and found to comply with the specifications set for a class B computing device in accordance with those specifications listed in subpart J of part 15 of the FCC rules. These rules are designed to provide a reasonable measure of protection against such interference. However, this does not guarantee that interference will not occur. If your professional music equipment should be suspected of causing interference with other electronic devices, verification can be made by turning your combo equipment off and on. If the interference continues when your equipment is off, the equipment is not the source of interference if your equipment does appear to be the source of the interference, you should try to correct the situation by using one or more of the following measures:

Relocate either the equipment or the electronic device that is being affected by the interference. Utilize power outlets for the professional music equipment and the device being affected that are on different branch (circuit breaker or fuse) circuits, or install AC line filters.

In the case of radio or TV interference, relocate the antenna or, if the antenna lead-in is 300 ohm ribbon lead, change the lead-in to co-axial type cable.

If these corrective measures do not produce satisfactory results, please contact your authorized Yamaha professional products dealer for suggestions and/or corrective measures.

If you cannot locate a franchised Yamaha professional products dealer in your general area contact the professional products Service Department, Yamaha Music Corporation, 6600 Orangethorpe Ave., Buena Park, CA 90620, U.S.A.

If for any reason, you should need additional information relating to radio or TV interference, you may find a booklet prepared by the Federal Communications Commission helpful:

"How to Identify and Resolve Radio —TV Interference Problems". This booklet is available from the U.S. Government Printing Office, Washington D.C. 20402 — Stock No. 004-000-00345-4.



DX7S OM

3/10/99 19C0170

YAMAHA

YAMAHA CORPORATION
P.O. Box 1, Hamamatsu, Japan

VD72740 88 04 2.1 CR Printed in Japan