

FS-70
FS-50

MAKING THE MOST OF YOUR ELECTONE
BEDIENUNGSANLEITUNG, FÜR DIE NEUE YAMAHA-ELECTONE-GENERATION
POUR TIRER LES MEILLEURES PERFORMANCES DE VOTRE ELECTONE
CÓMO APROVECHAR AL MÁXIMO SU ELECTONE

YAMAHA ELECTONE®

FS-50

Glide PAGE13

Upper Special Presets PAGE7

Auto Rhythm PAGE16

Lower Special Presets PAGE9

Auto Arpeggio PAGE19

Lower Orchestra PAGE20

Pedal Custom Voices PAGE109

Master Volume PAGE11

Upper Orchestra PAGE20

Upper/Lower Custom Voices PAGE8

Auto Bass/Chord PAGE21

Lower Combination PAGE9

Pedal Combination PAGE10

Rhythmic Chord PAGE20

Upper Combination PAGE4

Ensemble PAGE3

Sustain PAGE13



Combination PAGE5

Manual Balance PAGE15

Reset PAGE20

Reverb PAGE13

Play Assist PAGE20

Rhythm Sequence Programmer PAGE18

Registration Memory PAGE25

Vibrato PAGE14

Tremolo Speed PAGE13

Registration Pack PAGE27

Tremolo PAGE13

Power PAGE11

Symphonic PAGE13

FS-70

Glide PAGE15

Upper Special Presets PAGE7

Auto Rhythm PAGE16

Lower Special Presets PAGE9

Auto Arpeggio PAGE19

Lower Orchestra PAGE9

Pedal Custom Voices PAGE18

Master Volume PAGE11

Upper Orchestra PAGE9

Upper/Lower
Custom Voices PAGE8

Auto Bass/Chord PAGE21

Lower Combination PAGE9

Pedal Combination
PAGE10

Rhythmic Chord
PAGE20

Upper Combination PAGE4

Ensemble PAGE3

Sustain PAGE13



Combination
PAGE5

Manual Balance PAGE15

Reset PAGE26

Reverb PAGE15

Registration Memory PAGE25

Rhythm Sequence Programmer PAGE18

Play Assist PAGE23

Tremolo Speed PAGE13

Solo PAGE11

Vibrato PAGE14

Tremolo PAGE13

Registration Pack PAGE27

Symphonic PAGE13

Power PAGE11

Welcome to Yamaha's spectacular new world of music!

The Electone introduced in this manual is the avant-garde of electronic organs. It has been perfected through Yamaha's concerted efforts to meet the most stringent demands of the professional musician. With increased high-performance capability it produces dynamic sound, has completely new expression functions, and a design which facilitates the musician's concentration on the actual performance. By these and other outstanding features, some of which are explained below, this Yamaha Electone greatly surpasses the performance possibilities of previous electronic organs.

- FM (Frequency Modulation) System is used as the sound source circuit. Realistic and rich sounds, from acoustic sound to dynamic tones, can be obtained with this new system.
- It is provided with a Registration Memory by which the setting for all of the function buttons and sliders can be stored in the Electone's memory. It also has a variety of memory functions.
- With touch tone controls, the musician can now change the sound volume and tone to a subtle degree by varying the pres-

sure on the keyboard and can create new musical expressions.

- A greater variety and wider range of sound is now possible, as well as a larger number of instrumental combinations.
- Clear rhythm sound and a wide variety of rhythm patterns can be realized with the waveform memory system.
- Besides Auto Arpeggio, Rhythmic Chord, and Auto Bass/Chord, a new function called Play Assist has been added to make the auto functions even more complete.
- A 3 channel multi-sound system has been incorporated to achieve a forceful three-dimensional reverberation.

With these features, the New YAMAHA ELECTONE has an increased musical capability, power of expression and epoch-making tone quality. Yamaha is certain that this Electone will meet your expectations as a musical instrument which creates a spectacular world of music.

Before playing your Electone, master the instructions given in this

Willkommen in YAMAHA's einzigartig neuer Welt der Musik!

Die in dieser Bedienungsanleitung vorgestellte neue ELECTONE ist die modernste elektronische Orgel, die es heute gibt. Sie ist das Ergebnis langer Entwicklungsarbeit seitens YAMAHA mit dem Ziel, auch die höchsten Ansprüche des professionellen Musikers zu erfüllen. Die Leistungsfähigkeit der neuen YAMAHA-Electone-Generation wurde dabei entscheidend verbessert. Insbesondere der dynamische Sound eröffnet völlig neue Ausdrucksformen. Das neue Design ermöglicht es dem Spieler, sich ganz auf die musikalische Darbietung zu konzentrieren. Die besonderen Merkmale der neuen YAMAHA Modelle möchten wir Ihnen in dieser Bedienungsanleitung vorstellen und erläutern. Sie sollen dazu beitragen, die breite Palette der Möglichkeiten noch besser zu nutzen, denn diese neue YAMAHA-Electone-Generation übertrifft die Leistungsfähigkeit aller bisherigen elektronischen Orgeln bei weitem.

- Als Klangerzeugung dient das neue FM-System (Frequenz-Modulation), mit dem sich ein breites Spektrum von noch realistischeren Klangbildern, die vom typischen Akustikton bis zum

dynamisch modernen Sound reichen, erzielen läßt.

- Zur Ausstattung gehören neben einem Registrierspeicher, mit dem sich die Einstellung aller Funktionstasten und Schieberegler speichern lassen, auch viele andere Speicherfunktionen.
- Die auf leichte Berührung ansprechenden Klangregler versetzen den Spieler jetzt in die Lage, Lautstärke und Klangfarbe in sehr kleinen Abstufungen zu variieren, indem er den Druck seiner Finger auf das Manual verändert. Dadurch wird die musikalische Ausdrucksfähigkeit noch vielfältiger.
- Die neuen Modelle verfügen über eine noch umfangreichere Auswahl von Klangmöglichkeiten. Auch die Zahl der Instrumentenkombinationen wurde vergrößert.
- Mit Hilfe des Wellenform-Speichersystems lassen sich sowohl ein klarer Klang der Rhythmusbegleitung als auch eine Vielzahl von rhythmischen Begleitfiguren realisieren.
- Neben automatischem Arpeggio, rhythmischer Akkordbegleitung und automatischer Baßakkordbegleitung gibt es jetzt auch die

Yamaha vous souhaite la bienvenue dans son monde spectaculaire de la musique!

L'Electone introduit dans ce mode d'emploi représente l'avant-garde des orgues électroniques. Perfectionné grâce au savoir-faire immense de Yamaha, cet appareil répond aux exigences les plus diverses de tout musicien professionnel. Ses possibilités élargies de hautes performances procurent un son dynamique, ouvrent des horizons d'expression nouveaux tout en offrant au musicien un design facilitant sa concentration sur des performances inédites. De plus, grâce à des caractéristiques sans pareilles sur lesquelles nous feront la lumière ci-dessous, l'Electone de Yamaha surpasse de loin toutes les orgues électroniques conçues jusqu'à ce jour.

- Le système de modulation de fréquence (FM) fonctionnant comme circuit de source sonore permet d'obtenir une gamme sonore riche et réaliste, des sonorités acoustiques aux tonalités dynamiques.
- La mémoire des registres permet de stocker dans la mémoire de l'Electone les réglages de l'ensemble des touches et des curseurs. Cet appareil est en outre équipé d'une grande variété de fonc-

tions de mémoire.

- Les touches de tonalité permettent au musicien de modifier le volume sonore et la tonalité avec une grande sensibilité par des variations de pression sur le clavier et d'élargir ainsi le champ de ses possibilités d'expression musicale.
- Cet appareil offre enfin une grande variété de sons, une gamme sonore large ainsi qu'un nombre plus important de combinaisons instrumentales.
- Le système de mémoire à forme ondulatoire permet d'obtenir un rythme sonore détaillé et une grande variété de modèles rythmiques.
- Outre les fonctions d'arpège automatique, d'accord rythmique et de basse/accord automatique, cet appareil bénéficie d'une nouvelle fonction dite d'assistance à la lecture qui vient compléter l'ensemble des fonctions automatiques.
- L'incorporation d'un système multi-sonore à 3 canaux permet d'obtenir un effet de répercussion sonore à trois dimensions de

!Bienvenido al mundo espectacular de la música de Yamaha!

El Electone que vamos a presentar en este manual es lo último en órganos electrónicos. Ha sido perfeccionado por Yamaha para satisfacer la demanda exigente de los músicos profesionales. Gracias a su nuevo funcionamiento de gran calidad, produce un sonido dinámico, posee funciones de expresión totalmente nuevas y un diseño que facilita la concentración del músico en su actuación. Con estas y otras peculiaridades, explicadas a continuación, este Electone de Yamaha supera con mucho las posibilidades de los órganos electrónicos anteriores.

- Como circuito generador de sonidos se utiliza un sistema MF (modulación de frecuencia) gracias al cual se consiguen sonidos ricos y auténticos, desde los acústicos a los tonos dinámicos.
- Va equipado con una Memoria de Registro que permite almacenar los ajustes de los botones y palanquitas de función. Asimismo posee varias funciones de memoria.
- Con los controles de toque manual del tono, el músico puede

cambiar el volumen y el tono en un grado sutil, variando la presión de los dedos sobre el teclado, y poder crear nuevas expresiones musicales.

- Hemos aumentado las variedades y gama de sonidos, además del número de combinaciones instrumentales.
- Con el sistema de memoria de formas de onda pueden realizarse sonidos rítmicos claros y una gran variedad de modelos rítmicos.
- A las funciones de Arpeggio, Acorde Rítmico y Bajo/Acorde, se añade una nueva denominada "Play Assist" para hacer aún más completas las funciones automáticas.
- Se ha incorporado un sistema multisonoro de tres canales para conseguir un potente eco tridimensional.

Con estas funciones se ha aumentado la capacidad musical y el poder de expresión del nuevo ELECTONE YAMAHA con una calidad de tono que hace época. Yamaha está en la certeza de

manual concerning its correct use. Then, you can enjoy playing the instrument to its fullest potential. The section "Looking After Your Electone" (Page 29) is important, so be sure to read it carefully.

I. Producing Sound from the Various Keyboards and Pedals	1
II. Understanding the Various Functions	
• Ensemble section	3
• Tone Groups for the Upper Keyboard	4
Combination • Orchestra • Special Presets • Custom Voices	
• Tone Groups for the Lower Keyboard	9
• Tone Groups for the Pedals	10
• Tones and Effects for the Solo Keyboard	11
• Effects and Controls	13
• Auto Rhythm Section	16
• Auto Functions	19
Auto Arpeggio • Rhythmic Chord • Auto Bass/Chord • Play Assist	
• Registration Memory	25
III. Useful Information About Using the Electone	
• Accessory Jacks, Tone Cabinet Connectors	28
• Looking after Your Electone	29
• Troubleshooting and Misleading Phenomena	30
• Specifications	31

INHALTSVERZEICHNIS

neue Funktion "Play-Assist", die die Automatikfunktion weiter vervollständigt.

- Neu ist auch das Dreikanal-Multisound-System. Damit wird ein voller dreidimensionaler Halleffekt erzeugt.

Alle diese Besonderheiten steigern die musikalische Vielfaltigkeit, Ausdruckskraft und Klangqualität der neuen YAMAHA-Electone. YAMAHA ist davon überzeugt, daß sich mit dieser Electone-Orgel eine einzigartige Klangwelt schaffen läßt, die alle Ihre Wünsche und Vorstellungen erfüllen wird. Bevor Sie jedoch mit dem Spielen Ihrer Electone beginnen, sollten Sie sich mit den in dieser Anleitung enthaltenen Informationen für die richtige Bedienung gründlich vertraut machen. Wenn Sie anschliessend mit dem Spielen beginnen, werden Sie die vielen Vorzüge dieses Instruments voll ausnutzen können und es um so mehr genießen. Bitte lesen Sie auch den wichtigen Abschnitt "Wartung und Pflege Ihrer Electone-Orgel" (Seite 29) sorgfältig.

I. Klangerzeugung mit den verschiedenen Manualen und dem Pedal	1
II. Erklärung der verschiedenen Funktionen	
• Ensemble-Teil	3
• Registergruppen für das obere Manual	4
Combination (Kombinationen) • Orchestra (Orchesterstimmen)	
Special Presets (Vorwahlstimmen) • Custom Voices (Solostimmen)	
• Registergruppen für das untere Manual	9
• Registergruppen für das Pedal	10
• Register und Effekte für das Solo-Manual	11
• Effekte und Bedienungselemente	13
• Rhythmus-Automatik-Teil	16
• Automatikfunktionen	19
Auto Arpeggio (Automatisches Arpeggio) • Rhythmic Chord	
(Rhythmische Akkordbegleitung) • Auto Bass/Chord (Automatische	
Baß- und Akkordbegleitung) • Play Assist (Spielhilfe)	
• Registrierungs-Speicher (Registration Memory)	25
III. Praktische Informationen über den Gebrauch Ihrer Electone-Orgel	
• Zubehörschlußbuchsen, Tonkabinett-Anschlüsse	28
• Wartung und Pflege Ihrer Electone-Orgel	29
• Störungsbeseitigung und vermeintliche Störungen	30
• Technische Daten	31

TABLE DES MATIÈRES

grande puissance.

L'ensemble de ces caractéristiques a permis à l'ELECTONE YAMAHA de développer ses possibilités musicales, de renforcer sa puissance d'expression et de prétendre à une qualité sonore digne des temps modernes. Chez Yamaha, nous sommes certains que cet Electone répondra à toutes les exigences que l'on est en droit d'attendre d'un tel instrument et nous vous souhaitons la bienvenue dans notre monde spectaculaire de la musique.

Pour tirer le meilleur parti de cet instrument, prière de lire attentivement la section de ce mode d'emploi intitulée "Entretien de l'Electone" en page 29 et en respecter scrupuleusement les recommandations.

I. Production sonore au moyen des différents claviers et pédales	1
II. Exposé des différentes fonctions	
• Section d'ensemble	3
• Groupes de tonalités pour clavier supérieur	4
Combination (Combinaison) • Orchestra (Orchestre) • Special Presets	
(Préréglages spéciaux) • Custom Voices (Jeux spéciaux)	
• Groupes de tonalités pour clavier inférieur	9
• Groupes de tonalités pour pédalier	10
• Effets et tonalités pour clavier solo	11
• Effets et commandes	13
• Section de rythme automatique	16
• Fonctions automatiques	19
Auto Arpeggio (Arpège automatique) • Rhythmic Chord (Accord rythmique)	
Auto Bass/Chord (Basse/accord automatique) • Play Assist (Assistance à la lecture)	
• Mémoire des registres	25
III. Conseils pratiques à l'usage de l'Electone	
• Prises accessoires/Connecteurs de caisse de tonalité	28
• Entretien de l'Electone	29
• Dépistage des pannes et des erreurs de manipulation	30
• Caractéristiques techniques	31

INDICE

satisfacer sus anhelos con un instrumento musical capaz de crear un mundo espectacular de música.

Antes de comenzar a tocar su Electone, domine las instrucciones del manual referentes a su correcto manejo para que pueda disfrutar del mismo en su plena capacidad.

La sección "Cuidados de su Electone" (p. 29) es de gran importancia; recomendamos la lea con detenimiento.

I. Sonidos de teclados y pedales	1
II. Comprensión de las distintas funciones	
• Ensemble (Sección de conjunto)	3
• Grupos de tonos del teclado superior	4
Combination (Combinación) • Orchestra (Orquesta) • Special Presets	
(Preajustes especiales) • Custom Voices (Voces especiales)	
• Grupos de tonos del teclado inferior	9
• Grupos de tonos de los pedales	10
• Tonos y efectos del teclado solista	11
• Efectos y controles	13
• Sección de ritmo automático	16
• Funciones automáticas	19
Auto Arpeggio (Arpeggio Automático) • Rhythmic Chord (Acorde rítmico)	
Auto Bass/Chord (Bajo/acorde automático) • Play Assist (Ejecución asistida)	
• Memoria de registro	25
III. Información útil para el manejo del electone	
• Tomas para accesorios, Conectores de la caja de tonalidad	28
• Cuidados de su Electone	29
• Localización de averías y fenómenos engañosos	30
• Especificaciones	31

I. Producing sound from the various keyboards and pedals

1. **Connect the plug to ON outlet.**

Before inserting the plug, make sure the power outlet has the correct voltage. A Yamaha serviceman should be consulted regarding any changes in the voltage system.

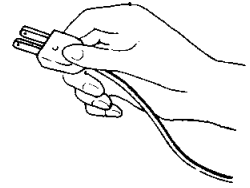
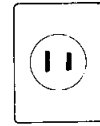

2. **Turn on the POWER SWITCH.**

The power indicator lamp will light up.

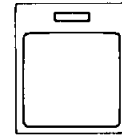

POWER

3. **Turn the MASTER VOLUME knob clockwise.**

As you turn the knob the volume will increase. The volume for the entire instrument is controlled with this knob.

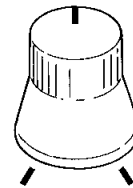

MASTER VOLUME

6. **Set the buttons and sliders on the front control panel just like they are set in the diagram.**

Now, experiment with the sounds from each of the keyboards and the pedals.

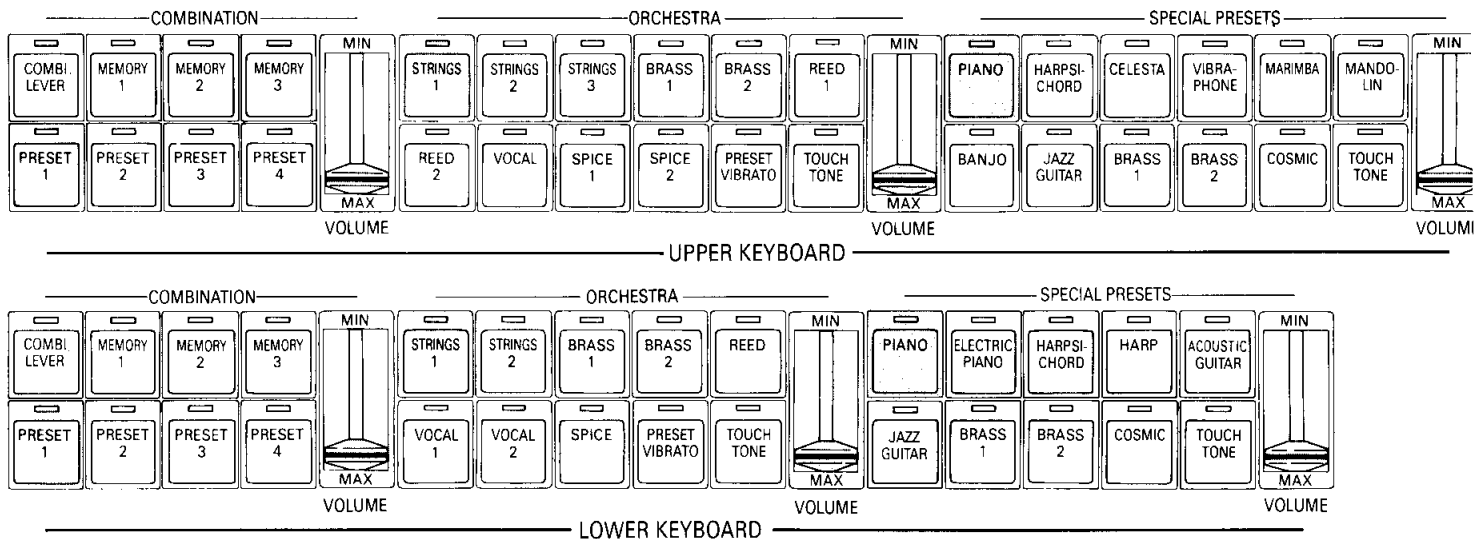

You have now produced the following tones from these three sections:

- Upper keyboard** : Organ sound + Strings + Piano + Flute
- Lower keyboard** : Organ sound + Strings + Piano
- Pedals** : Organ sound + Contra Bass

★ A Solo Keyboard is also provided in Model FS-70. (Refer to Page 11 for further details.)

4) **Depress the Expression Pedal.**

During a performance, subtle changes in the volume can be controlled by using this pedal.

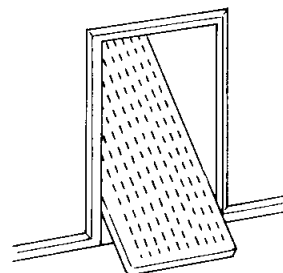

5) **Push the RESET button.**

When you push the reset button, all the sections on the control panel will turn off or will return to normal position.

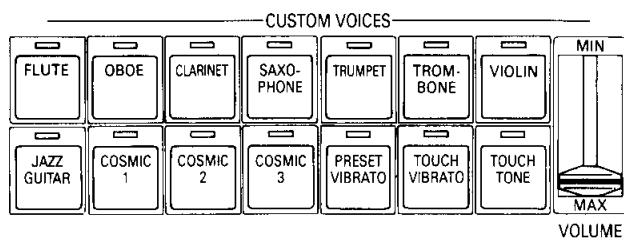
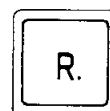

— UPPER/LOWER —

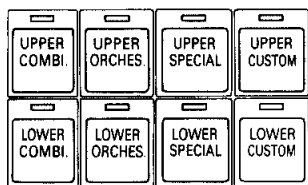

— ENSEMBLE —

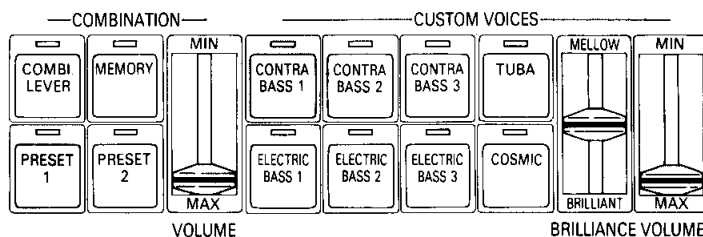

— PEDALS —

★ Here is a chart for the combination of keyboards and number of keys which can be simultaneously played.

Upper keyboard	}	A maximum of 12 keys on both keyboards
Lower keyboard		
Pedals	}	1 key, respectively
Solo keyboard		

II. Understanding the various functions

Ensemble Section

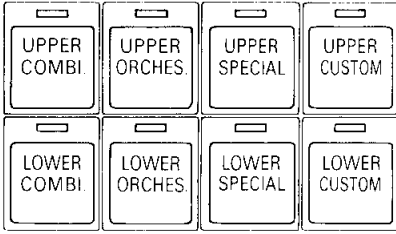

ENSEMBLE

The function of this section is to centrally control the tone groups for the upper and lower keyboards. Since this function enables you to create a new one or cancel an tone group you do not want just by depressing the buttons, it is easy to quickly change or mix tones even during a performance.

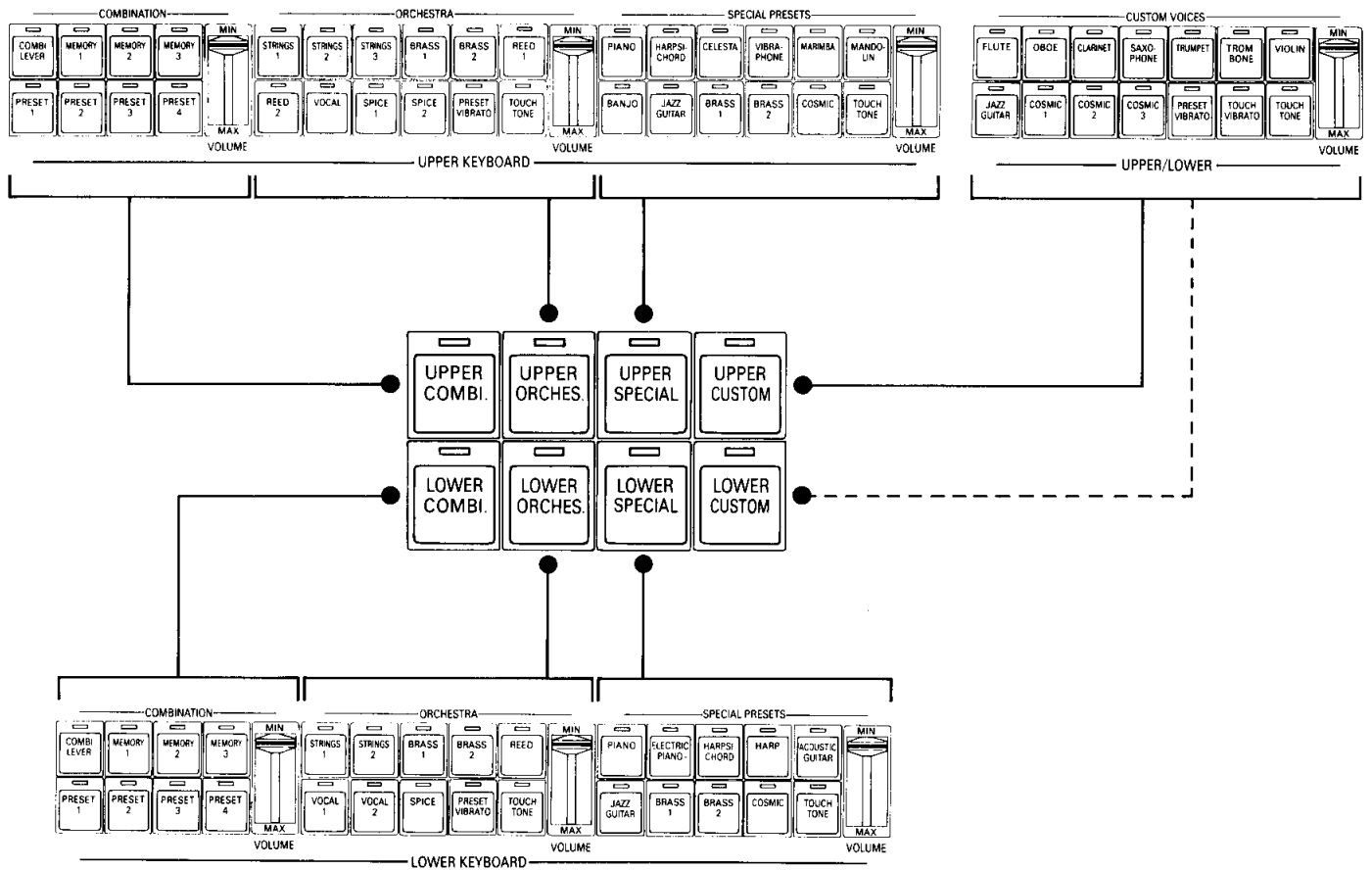

As the diagram above illustrates, the upper row of buttons in the Ensemble section corresponds to the tone group of the upper keyboard, while the lower row of buttons corresponds to the tone group of the lower keyboard. A maximum of four tone groups can be created for each of the upper and lower keyboards. Also, you can select which keyboard to use with the Upper/Lower Custom Voices.

★ An explanation for each of the tone groups which can with the Ensemble section will begin on the next page. Be sure to press the RESET button before beginning any of these operations.

Tone Groups for the Upper Keyboard

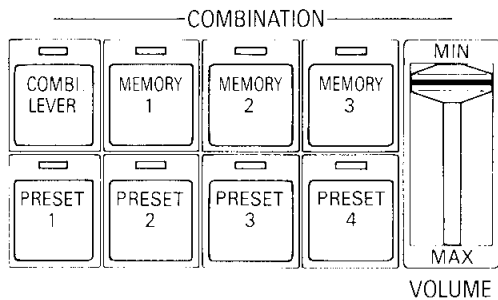

Combination

In this tone group various organ sounds can be obtained by using a single button. First, try the organ sound which is preset in the Electone. There are eight tone select buttons. Select one of them and set it on.

- 1) Push the **UPPER COMBINATION** button in the **ENSEMBLE** section to the **ON** position.

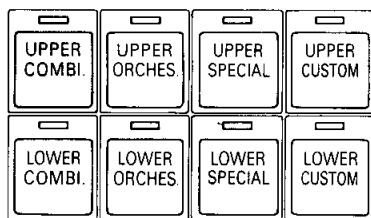

ENSEMBLE

Now, the Upper Combination will be called.

- 2) Select one of the 4 **PRESET** buttons by depressing it.

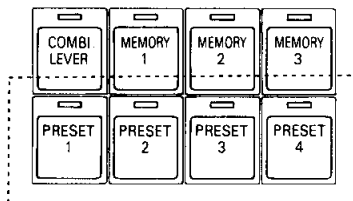

Select one of these.

- 3) Move the **VOLUME** slider down.

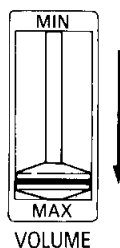

When it is set at the top, the volume is zero. As you move the slider down the volume will increase.

Having set the Electone like this, when you play the upper keyboard, the tone group you selected in Step 2 will be produced. Now change the PRESET tone and compare the sound difference.

[Tones obtained from the various buttons]

In the Combination section there are buttons for producing predetermined tones and buttons for producing the tone which you have set. These are respectively located on the lower and upper rows. The tones which can be obtained with these 8 buttons are as follows:

COMBI. LEVER: During a performance, by using this Combination Lever button you can obtain the tone which is set with the levers on the preset panel. (Refer to the next page.)

MEMORY 1.2.3: With these buttons you can store the tone you set using the levers on the preset panel into memory. (Refer to the next page.)

PRESET 1.2.3.4: Frequently used organ sounds are preset with these buttons.

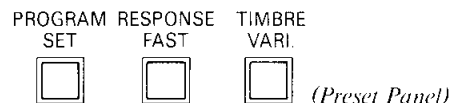
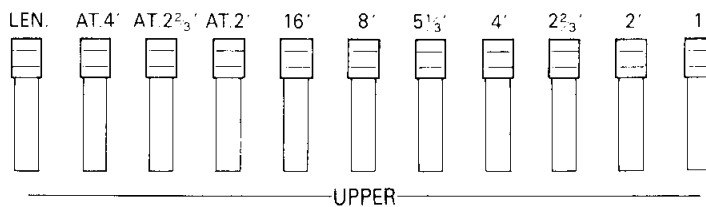
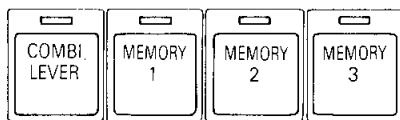

[Setting Tones with the Levers]

When you select the COMBI.LEVER button, you can obtain the tone which is set by the UPPER FLUTE and UPPER ATTACK levers on the preset panel. Click stops are provided for each of these levers. The further you pull them forward, the louder you can set the volume. This enables you to finely set the volume for each of the levers. With these levers it is possible to produce subtle shades of volume just the way you want.

FLUTE levers: You can create various organ sounds by combining the optional levers. The numbers above the levers indicate the respective sound intervals, and 7 possibilities are available for the Upper Flute.

(Sound intervals for the levers when middle C is pressed.)

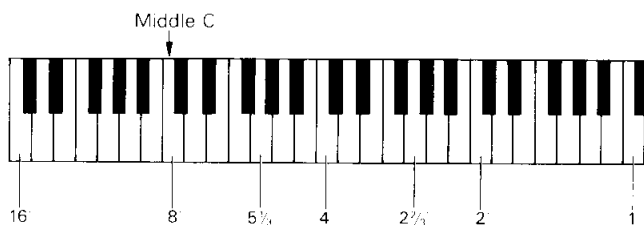

ATTACK and ATTACK LENGTH levers: Attack tones are short notes with a rapid rising of sound. When they are set together with the Flute tones, a crisp sound can be produced.

The time length of the Attack tones can be controlled with the LENGTH lever.

[Storing the Setting for the Levers in Memory]

Using the 3 MEMORY buttons, you can store the tone which was set with the FLUTE and ATTACK levers into memory before a performance. Then without having to set the levers while performing, you can create the tone you want with a single touch.

- 1) Using the levers, set the tone you want stored in memory.
- 2) While you are pressing the PROGRAM SET button on the preset panel, set 1 of the 3 MEMORY buttons located on the control panel.

When the indicator light for the on MEMORY button flashes, it indicates that the tone has been stored in memory.

★ Once a tone has been stored in memory, it will not be erased until a new tone is set using the same button, even if the power is turned off.

■ RESPONSE FAST

When this button is on, the rising and falling sound of the Combination tone become sharp, and a hard sound is produced.

■ TIMBRE VARIATION

When this button is on, the Combination tone changes and a sparkling full sound can be produced. The timbre of Upper and Lower flute 16', 8', 4', is changed.

★ Both RESPONSE FAST and TIMBRE VARIATION can be stored in memory using PROGRAM SET and 3 MEMORY buttons.

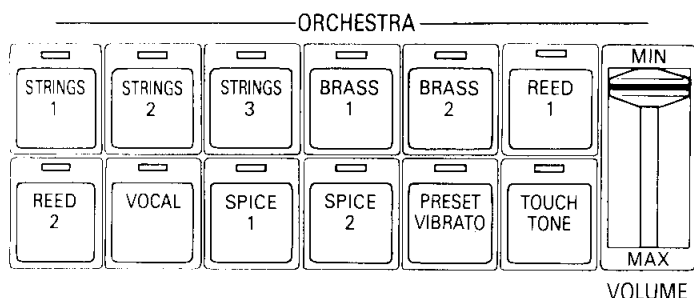

Orchestra

With this tone group a rich orchestral ensemble can be obtained. The buttons which are set represent strings, brass, and the sounds of other major instruments of an orchestra. An appropriate effect for each of these color-tones can be combined before a performance. Now, experiment with these sounds.

- 1) Set on the UPPER ORCHESTRA button in the ENSEMBLE section.**

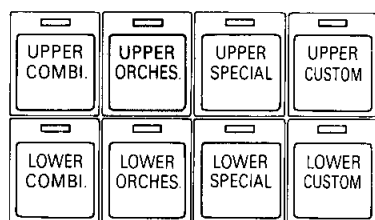

ENSEMBLE

- 2) Select 1 of the 10 buttons whose tone you prefer and set it on.**

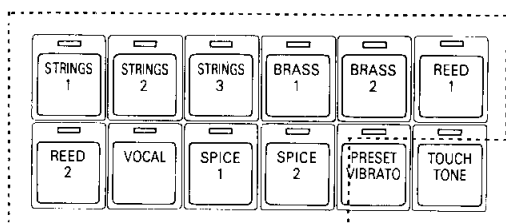

Select one of these

- 3) Move the volume slider down.**

Having set the Electone like this, when you play the upper keyboard, the tone you selected in Step 2 will be produced. Now depress the other buttons and compare the sounds.

- ★ When you set the Orchestra button on, the SYMPHONIC effect will automatically be produced for the STRINGS 2 and VOCAL tones.

PRESET VIBRATO



When this button is on, a Vibrato effect, causing minute alterations in pitch for the selected tone, will be produced. The Vibrato depth, speed and delay timing, appropriate for the individual tones, are all preset.

- ★ You can also preset the Vibrato yourself. (Refer to Page 14.)

TOUCH TONE



When this button is on, the volume and tone can be subtly controlled by the pressure of your touch. Two types of touch control are possible according to how you strike the keyboard. Initial Touch Control causes the volume and tone to change when you first strike the keyboard. After Touch Control causes similar changes when after striking the keys you exert further pressure on them. These controls can be used to create even more expressive performances. The degree of change differs for each of the tones.



SPECIAL PRESETS

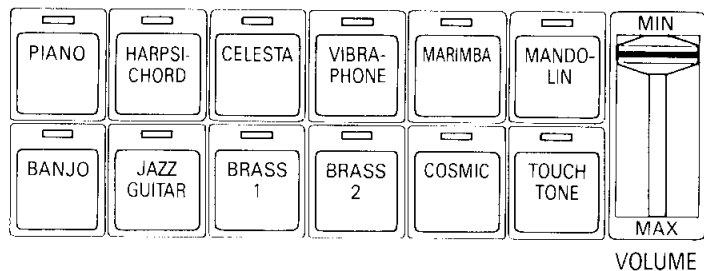

Special Presets

This is a tone group in which the piano, vibraphone and other instrumental sounds are preset. With this group you can recreate the clear sound which is the distinguishing quality of a particular musical instrument, such as the rapid diminuendo of the piano and harpsichord or the repeating effect of a marimba and mandolin. Now, experiment with one of these sounds.

- 1) Push the **UPPER SPECIAL** button in the **ENSEMBLE** section to the **ON** position.

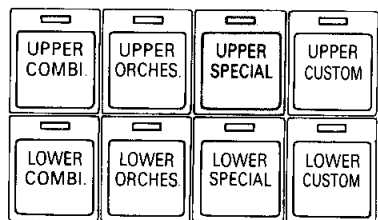

ENSEMBLE

- 2) Select 1 of the 11 buttons whose tone you prefer and by depressing it.

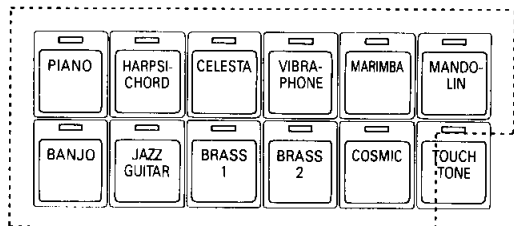

Select one of these

- 3) Move the volume slider down.

Having set the Electone like this, when you play the Upper Keyboard, the tone you selected in Step 2 will be produced. Now depress the other buttons and compare the sounds.

TOUCH TONE



When this button is on, the volume and tone can be subtly controlled by the pressure of your touch, making an even more expressive performance possible. In the Special Presets Touch Tone, only the initial touch control, which causes the volume and tone to change when you first strike the keyboard, is provided. The degree of change differs for each of the tones.



Twin mallet effect

A twin mallet effect can be obtained for the reverberating sound of the MARIMBA. With this effect, by simultaneously pressing 2 or more keys, a sound will be produced where the highest and lowest tones are finely interrelated.

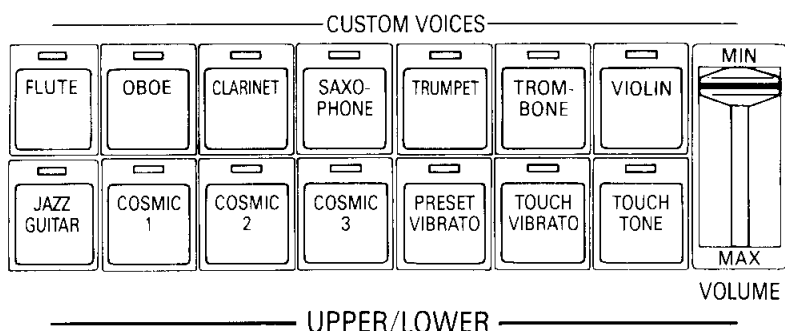

Custom Voices

With this tone group various instrumental sounds are obtained one tone at a time. Since the tones and volume can be subtly altered, extremely realistic sounds can be produced. Besides a variety of wind instrumental sounds, the fantastic COSMIC sound can be produced. Now, create one of these sounds.

- 1) Push the UPPER CUSTOM button in the ENSEMBLE section to the ON position.**

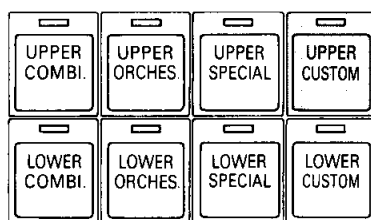

ENSEMBLE

You have your choice of using either the upper or lower keyboard for producing the Upper/Lower Custom Voices. Both keyboards cannot be simultaneously used to produce them.

- 2) Select 1 of the 11 buttons whose tone you prefer and set it on.**

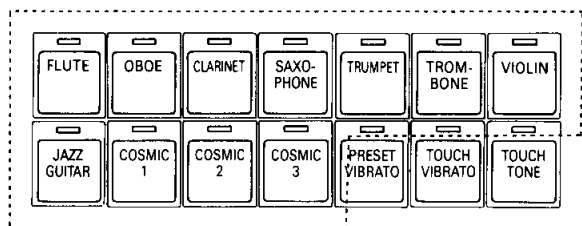

Select one of these.

- 3) Move the volume slider down.**

Having set the Electone like this, when you play the upper keyboard, the tone you selected in Step 2 will be produced. Now set the other buttons and compare each of the different tones.

- ★ With the Custom Voices only one note at a time can be produced. When it is combined with other tone groups and two keys or more are played simultaneously, only the highest pitch will be heard. When it is not combined with other tone groups, the note which was pressed last will be heard.
- ★ The slide effect is already incorporated in the tones.

PRESET VIBRATO and TOUCH VIBRATO



When the PRESET VIBRATO button is on, Vibrato will be produced for the tone which is selected. The Vibrato depth, speed and delay timing, appropriate for the individual tones, are all preset.

When the TOUCH VIBRATO button is on, the PRESET VIBRATO button goes off. By increasing or decreasing touch pressure while playing the keyboards, the Vibrato Depth can be controlled. The Vibrato speed is preset.

- ★ You can also preset the Vibrato yourself. (Refer to Page 14.)

TOUCH TONE

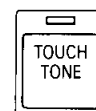

When this button is on, the volume and tone can be subtly controlled by the pressure of your touch. With the Upper/Lower Custom Voices, two types of touch control are possible according to how you strike the keyboard. Initial Touch Control causes the volume and tone to change when you first strike the keyboard. After Touch Control causes similar changes when after striking the keys you exert further pressure on them. The degree of change differs for each tone.

Tone Groups for the Lower Keyboard

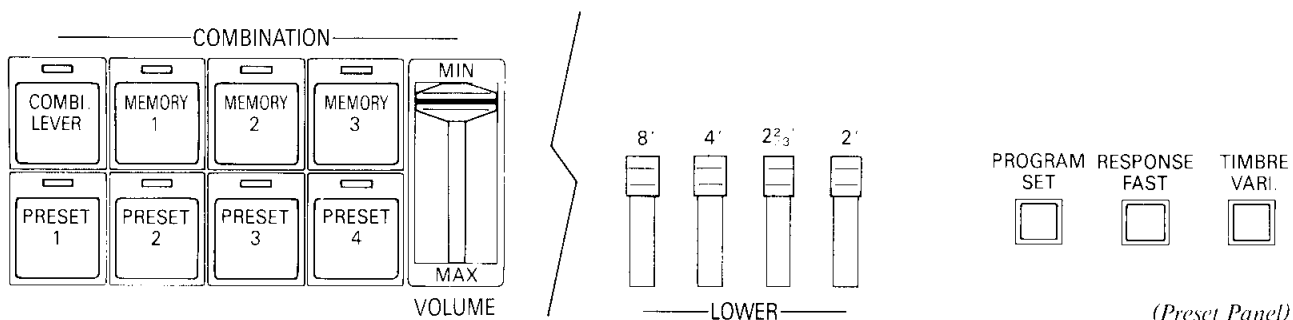

Combination

With this tone group an organ sound can be obtained using the lower keyboard. The operation of the 8 buttons on the panel and the PRESET tones is the same as the procedure used for the Upper Combination section. The tone can be created by using the LOWER COMBI-

NATION button in the ENSEMBLE section. The operation for storing a tone in memory, and using the RESPONSE FAST and TIMBRE VARIATION functions is the same as the procedure for the Upper Combination section. (Refer to Pages 4, 5.)

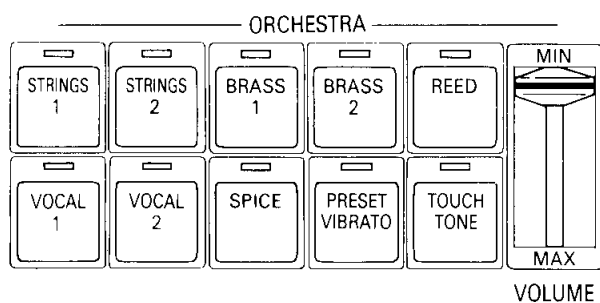

Orchestra

The method of operation and other aspects are similar to those for the Upper Orchestra section. You can create the tone by using the LOWER ORCHESTRA button in the ENSEMBLE section.

The PRESET VIBRATO and TOUCH TONE function are just like those in the Upper Orchestra section. (Refer to Page 6.)

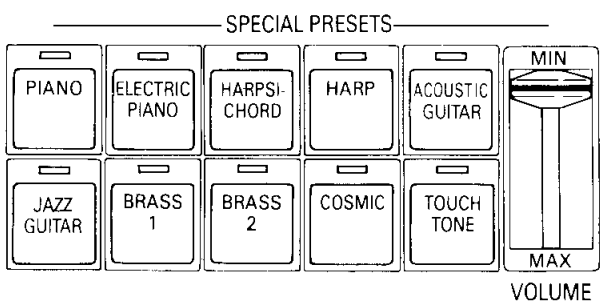

Special Presets

The method of operation and other aspects are similar to those in the Upper Special Presets section. You can create the tone by using the LOWER SPECIAL button in the ENSEMBLE section. The tone colors are slightly different from those in the Upper Special Presets section, however, the TOUCH TONE functions in a similar way. (Refer to Page 8.)

Custom Voices

When the LOWER CUSTOM button in the ENSEMBLE section is on, Custom Voices can be played on the lower keyboard. When the lower keyboard is being used, Custom Voices cannot be played on the upper keyboard. (Refer to Page 8.)

Tone Groups for the Pedals

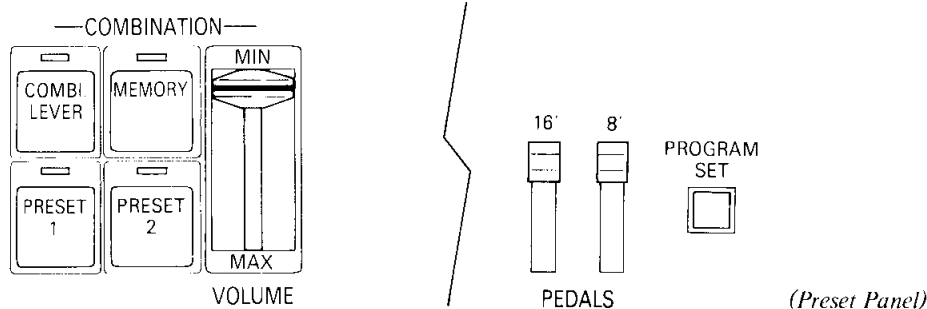

Combination

The bass sounds of an organ can be obtained with this tone group. It is different from the Combination section of the upper and lower keyboards. Here you do not have to set the button in the ENSEMBLE section. Sound can be produced merely by operating the VOLUME slider and the tone select buttons. The 4 buttons on the panel function just like those in the Upper Combination

section, and the operation for storing a tone in memory is also the same. (Refer to Pages 4, 5.)

You can also combine the tone group of this section with the Pedal Custom Voices. However, if you want to use the Combination tone by itself, be sure to move the VOLUME slider for the Pedal Custom Voices to the off position.

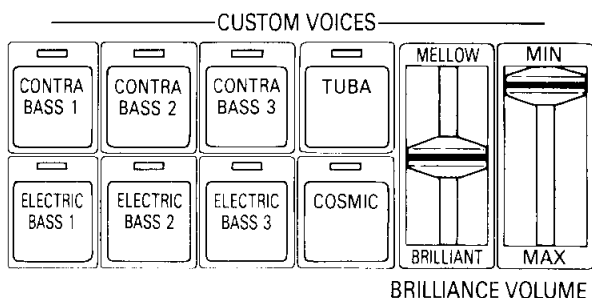

Custom Voices

The tones of bass instruments, such as the contra and electric bass, can be obtained using this tone group. Sound can be produced by selecting the required tone button among the 8 buttons and moving the VOLUME Slider down. You can also combine this group with the Pedal Combination. However, when you want to use the Custom Voices independently, make sure the Pedal Combination VOLUME slider is off.

■ BRILLIANCE

This slider controls the tone-color.

When the slider is in the central position the tone is normal. As the slider is moved upwards, the tone becomes soft, and as it is moved downwards the tone becomes more brilliant.

Tones and Effects for the Solo Keyboard (FS-70)

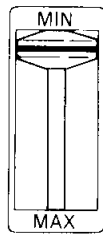

DETUNE

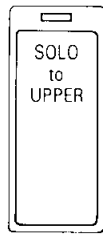

COUPLER

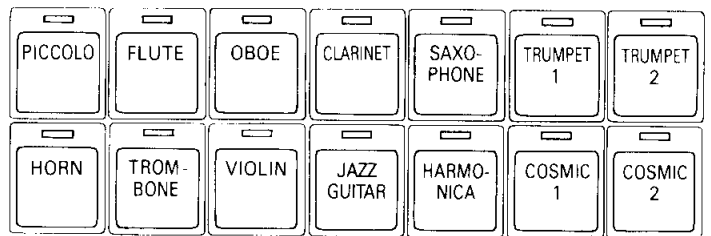

SOLO KEYBOARD

A higher timbre and more vibrant tones can be obtained using the Solo Keyboard. Through creative use of the various effects and controls, you can produce expressive music replete with variations. Moreover, by moving to the upper keyboard, it is possible to create combinations with other tone groups.

Solo Tones

The Solo Keyboard is provided with 14 different tones. By selecting one of these and moving the VOLUME slider down, you can produce sound from the Solo Keyboard. Now listen to each of the tones and compare them.

★ With the Solo Tones only one note at a time can be produced. When you simultaneously press a number of keys on the keyboard, the key which was pressed last will be heard.

When you use the COUPLER and move to the upper keyboard, if you create a combination with another tone group, the highest pitch will be heard.

■ COUPLER

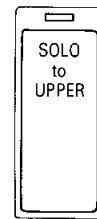

COUPLER

When this button is on, the Solo Tones can be produced on the upper keyboard, and they can be freely combined with the Upper Keyboard tone group.

Even when the COUPLER button is on, Solo Tones can be produced by playing the Solo Keyboard. However, when the Solo Keyboard is being played, Solo Tones cannot be produced from the upper keyboard.

■ DETUNE

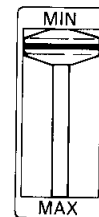

DETUNE

The music intervals for the Solo Tones can be subtly controlled with the slider. The DETUNE can be used to create your favorite effects. For example, a three-dimensional effect can be created by setting the music intervals for the Solo Tones slightly higher than those for the other keyboard tones. When the slider is moved to the uppermost position, the music interval is normal. As it is moved downwards, the music interval increases. The effect is similar to an instrument slightly out of tune.

—TRANSPOSITION—

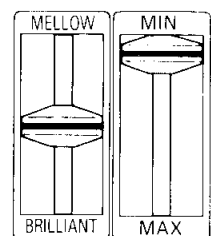
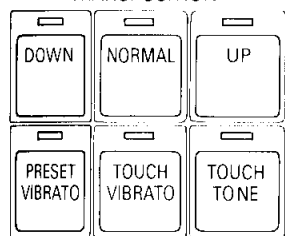

BRILLIANCE VOLUME

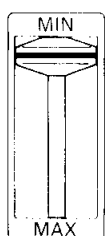

SLIDE CONTROL

■ TRANSPOSITION

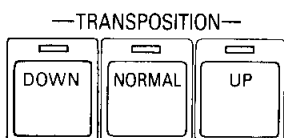

By using these buttons, you can change the musical intervals for the Solo Tones in octave units. When the DOWN button is on, the musical interval is 1 octave lower than NORMAL. When the UP button is on, the musical interval is 1 octave higher than NORMAL. Use these properly for individual tones and interpretations.

■ PRESET VIBRATO and TOUCH VIBRATO

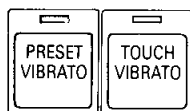

When the PRESET VIBRATO button is on, Vibrato will be produced for the tone which is selected. The Vibrato depth, speed and delay timing, appropriate for the individual tones, are all preset.

When the TOUCH VIBRATO button is on, the Preset Vibrato goes off. By increasing or decreasing touch pressure while playing the keyboards, the Vibrato depth can be controlled. The Vibrato speed is preset.

★ You can also preset both Vibratos yourself. (Refer to Page 14.)

■ TOUCH TONE



When this button is on, the volume and tone can be subtly controlled by the pressure of your touch on the keyboard. Both Initial Touch Control and After Touch Control can be used with the Solo Keyboard. (Refer to Pages 6, 8.) The degree of change differs for each tone.

■ BRILLIANCE

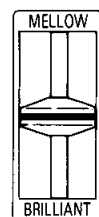

BRILLIANCE

This slider controls the tone-color. When the slider is in the central position, the tone is normal. As the slider is moved upwards, the tone becomes soft. As it is moved downwards, the tone becomes more brilliant.

■ SLIDE CONTROL

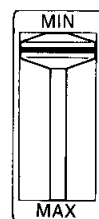

SLIDE CONTROL

When moving from one sound to another, you can connect the musical interval between them and create a sliding effect by using this function. When the SLIDE CONTROL is in the uppermost position, it is off. As you move it downwards, the slide effect becomes more exaggerated. When using this effect, play legato. This sliding effect is sometimes suitable for a Trombone.

Effects and Controls

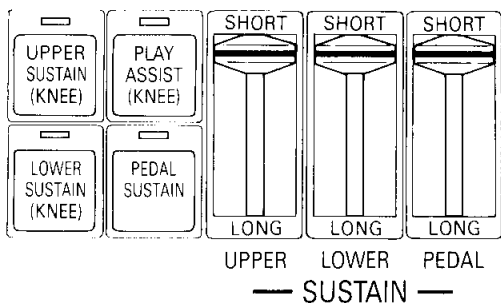

Sustain

With this effect there is a natural diminuendo after your finger leaves the keyboard. You can use this effect for each of the keyboards by operating the 3 buttons and 3 sliders.

(Sustain button for the Combination tones)

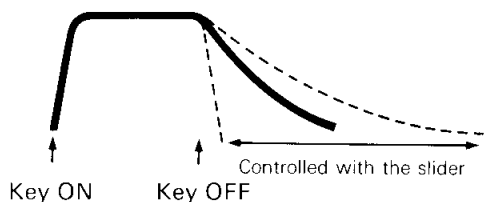

- 1) Determine which keyboard sound with which you will use this effect by using the 3 buttons: **UPPER SUSTAIN, LOWER SUSTAIN or PEDAL SUSTAIN.**

These 3 buttons can also be used simultaneously.

- ★ The sustain effect cannot be used for the tones obtained with the Upper/Lower Custom Voices.
- 2) Control the diminuendo for each of the keyboards and the pedals by using the 3 sliders: **UPPER, LOWER, or PEDAL.**

When the slider is in the uppermost position, it is off. As you move it downwards, the length of the diminuendo increases.

- ★ For tones which already have a long diminuendo, such as the HARP tone in the Lower Special Presets section, the diminuendo length can be decreased by moving the slider upwards.

■ Knee Lever Control

By using the Knee Lever you can switch the Upper Sustain and Lower Sustain on or off. First, push either or both of the Upper Sustain and the Lower Sustain buttons to the ON position, control the diminuendo by using the sliders, and then pull the Knee Lever down vertically. When you arrive at a point in a musical performance where you want to create the sustain effect, press the Knee Lever to the right. The sustain effect will only be produced during the time you are pressing the lever.

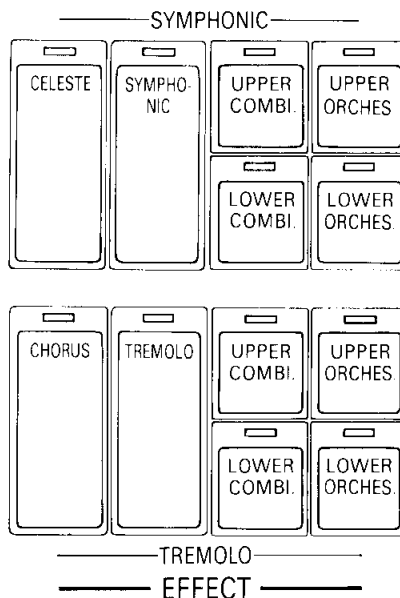
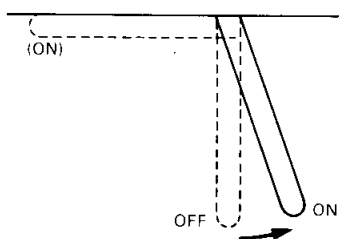

Symphonic

With this effect you can create an expansive sound as if a number of instruments were playing as an ensemble.

- 1) Push either the **SYMPHONIC or CELESTE** button to the **ON** position.

An effect more sedate than the one achieved using the SYMPHONIC button, can be obtained with the CELESTE button, as well as a majestic sound.

- 2) Select which tone group with which you will use this effect by using the 4 buttons.

You can use both or of either the Combination and Orchestra tone groups for the upper or lower keyboards.

Tremolo

With this effect there is a rapid repetition of a single tone creating a rich breadth of sound.

- 1) Push either the **TREMOLLO or CHORUS** button to the **ON** position.

A gentler repetition can be obtained by using the CHORUS button.

- 2) Select which tone group with which you will use this effect by using the 4 buttons.

■ TREMOLO SPEED



When the TREMOLO buttons are on, the speed of the repetition can be controlled with this knob.

- ★ It is not possible to create both a Symphonic and Tremolo effect for the same tone group. Try using the Symphonic effect for the Orchestra tone group and the Tremolo for the Combination tone group.

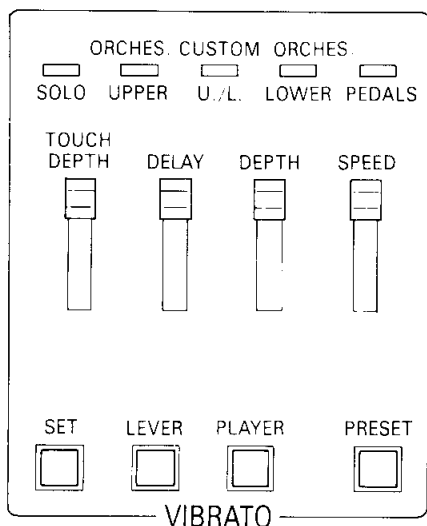
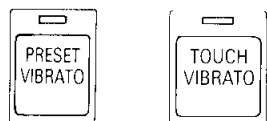

(Preset Panel)
(Illustration: FS-70)

Vibrato

A preset Vibrato appropriate for each tone is produced when either the PRESET VIBRATO or TOUCH VIBRATO buttons on the panel and the PRESET button on the preset panel are on. (Refer to Pages, 6, 7, 8, 12.) If you set the PLAYER button on instead of using the PRESET button, the Vibrato which was stored in memory using the levers on the preset panel can be obtained.

Storing Vibrato in memory

- 1) Push either the TOUCH VIBRATO button or the PRESET VIBRATO button for the tone group whose Vibrato you want stored in memory to the ON position.
- 2) Push the LEVER button to the ON position.



Subsequently, the lamp will flash which indicates that the vibrato has been stored in the memory.

- 3) Press the button for the tone whose vibrato you want stored in memory.

Subsequently, the indicator for the tone group you selected will light up.

- ★ The tone groups whose vibrato can be stored in memory are the Solo Tones (only model FS-70), Upper and Lower Orchestras, Upper/Lower Custom Voices, and the Pedal Custom Voices. Step 1, listed above, is not required for storing the vibrato of the Pedal Custom Voices in memory.

- 4) Determine the kind of Vibrato to be produced by using the levers.

Set the levers while actually playing. First, be certain to pull the DEPTH lever forward to determine the depth of the Vibrato. Likewise, the speed of the Vibrato can be controlled with the SPEED lever. The length of time between striking the keyboard and producing Vibrato for the tone can be controlled with the DELAY lever.

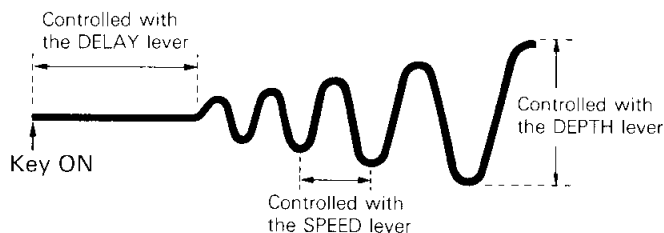

- ★ When TOUCH VIBRATO is selected in Step 1, the vibrato depth can be controlled with the TOUCH DEPTH lever.

- 5) Push the LEVER button while pressing the SET button.



Subsequently, the PLAYER button light will flash. This indicates that the memory procedure is complete. After finishing this procedure, if you set the PLAYER button on, the Vibrato determined in Step 4 for the tone selected in Step 3 will be produced.

- ★ Once the Vibrato has been stored in memory, it will not be erased even when the power is turned off, until a different Vibrato for the same tone is stored in memory.

Storing Preset Vibrato into memory

Vibratos which you have preset can be stored in memory by pressing the SET button while the PRESET button is simultaneously set. If you do this operation before storing Vibrato into memory, it will not be necessary to reset each of the PLAYER and PRESET buttons for the tones. In other words, even when you want to change from a tone whose vibrato is stored in memory to a tone whose vibrato is preset, you can obtain either of them just by leaving the PLAYER button on.

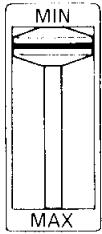

REVERB

Reverb

By using this sound reverberation effect, an echo can be created as if performing in a concert hall. This effect can be produced for all the keyboard tones. The length of the reverberation can be increased by moving the slider forward.

— FOOT SWITCH —

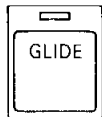

Glide

With this effect, the upper and lower keyboard tones as a whole can be lowered by approximately half a step. This effect is produced by setting the GLIDE button on and pressing to the left the Foot Switch located on left side of the Expression Pedal. While the Foot Switch is being pressed, whole steps will be lowered approximately by a half step. When the Foot Switch is no longer pressed, the musical interval will slowly return to normal. This can be used to play a glissando effect.

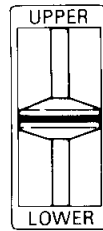

MANUAL
BALANCE

Manual Balance

The MANUAL BALANCE slider controls the balance of the volume between the upper and lower keyboards. The volume for the upper keyboard increases when it is set in the UPPER position, while the volume for the lower keyboard increases when it is set in the LOWER position.

OFF

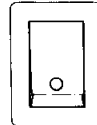

ON
LIGHTS

Panel Light (FS-70)

When you want to use the Panel Light, make sure the main switch located under the shelf board has been turned on.

■ PITCH CONTROL

The pitch for the entire Electone can be subtly controlled with the PITCH CONTROL knob. The pitch will become higher as the knob is turned to the right.

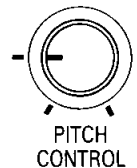

Auto Rhythm Section

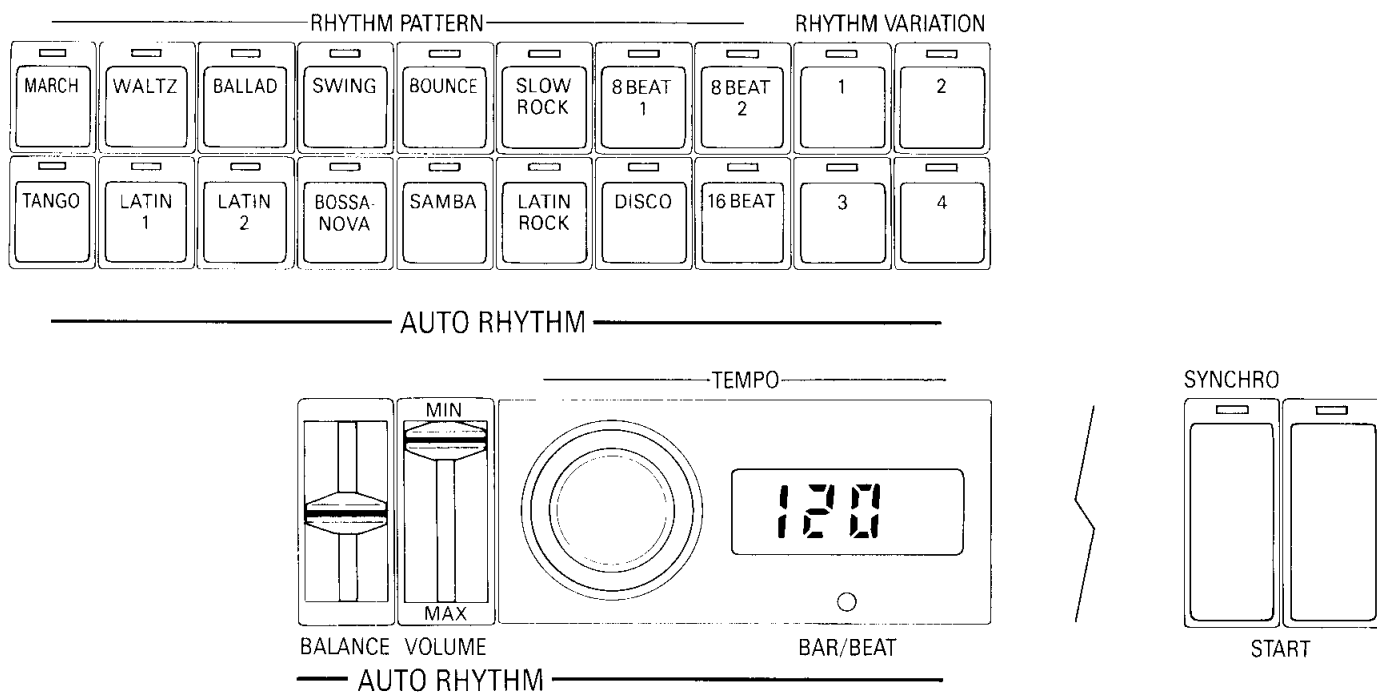

Rhythm Pattern and Variation

With 16 basic rhythm patterns you can create realistic rhythmic sounds similar to those of any percussion instrument. Each of the 16 rhythm patterns have four variations. Therefore, a total of 64 different patterns can be produced. Now try making some rhythm sounds.

- 1) Select 1 of the 16 Rhythm Pattern buttons and 1 of the Variation buttons by depressing them.
- 2) Move the VOLUME slider downwards.
- 3) Push the START button to the ON position.

Subsequently, the rhythm which you selected during Step 1 will start. Now, set the other buttons for the Rhythm Patterns and Variations and listen to the various rhythms.

■ START and SYNCHRO START

When the START button is on, the rhythm will start immediately. If the SYNCHRO START button is on instead, when the lower keyboard or pedals are played, it will simultaneously start the rhythm immediately.

■ TEMPO control

The TEMPO knob is used to control the rhythm speed. The tempo increases as the knob is turned to the right. A tempo which has been set will be displayed as digits on the Digital Display. The set tempo is also indicated by the flashing of the indicator lamp.

■ BALANCE control

The BALANCE slider is used to control the balance of the percussion instrument sounds forming the rhythm. When it is in the central position, the balance is normal. As the slider is moved downwards, the sound of the main percussion instrument keeping the rhythm is emphasized.

When the slider is moved upwards, all the other percussion instrument sounds are emphasized.

■ Digital Display

According to how the Rhythm section is being used, various indications such as the rhythm tempo will appear on the Digital Display.

Tempo display: Before starting the rhythm, the rhythm tempo will be displayed in number of quarter notes per minute. If the tempo is changed after the rhythm has been started, this changed tempo will be indicated on the display just for a short period of time.

Bar/Beat display: After the rhythm has been started, the number of bars from the start and the beat are displayed.

★ When the rhythm is stored in memory, only the number of bars is displayed. (Refer to Page 18.)

-BREAK VARIATION-

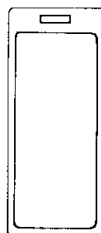
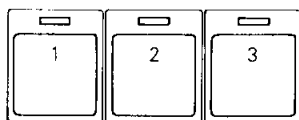

BREAK

Break Variation

With this function, you can break to an effective variation while the rhythm is playing. Used for such aspects as phrase change points, accent on the rhythm can be created. Now actually try using this function.

- 1) Start the rhythm.
- 2) Push on 1 of the 3 BREAK VARIATION buttons to the ON position.

A total of 48 different break variation patterns can be produced since there are 16 rhythms for each of the 3 buttons.

- 3) Depress the BREAK button.

Now, until the bar ends the Break Variation selected in Step 2 will be produced. With the next bar, the original rhythm will be resumed. When you want to create a longer Break Pattern, continue pressing the BREAK button.

Producing an Introduction

An introduction can be produced by using the Break Variation before starting the rhythm.

First, select the rhythm, and set the BREAK button. Then, if you start the rhythm with the START button, a 1-bar BREAK VARIATION pattern will be produced.

AUTO VARIATION



Auto Variation

With this function, there is an automatic change in rhythm at a phrase change point without depressing the BREAK button. The new pattern becomes the Break Variation selected at that time. Select the bar where you want the rhythm changed by using the 4 BAR, 8 BAR and 16 BAR buttons.

- ★ When the NORMAL button is turned on, the Auto Variation, and PROGRAM buttons go off.

Foot Switch controls

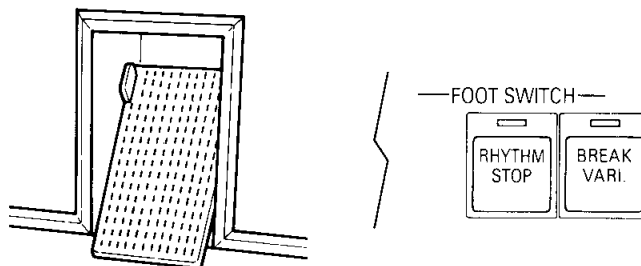

By using the Foot Switch located to the left of the Expression Pedal, you can stop the rhythm or switch to a Break Variation without using your hands.

RHYTHM STOP button: If this button is turned on, the rhythm will stop when the Foot Switch is pushed to the left. If the Foot Switch is pushed once more, the rhythm will start again.

BREAK VARIATION button: When this button is turned on, you can make the Break Variation start by pushing the Foot Switch to the left.

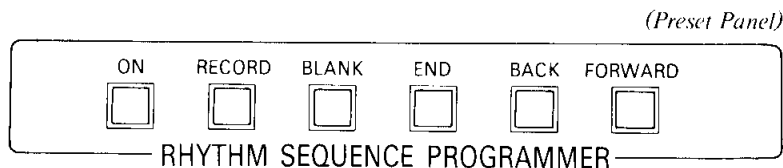
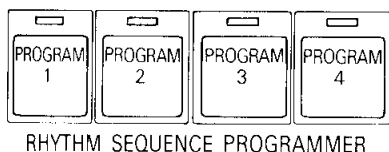

Rhythm Sequence Programmer

Various rhythm patterns can be stored in memory before a performance. These patterns can be played back during a performance by using this function. Since the rhythm will automatically change while the music is being played, it becomes possible to create a more colorful performance.

1) Push 1 of the 4 PROGRAM buttons to the ON position.

The rhythm pattern to be subsequently programmed will be stored in memory under the button which has been set on. Up to 64 bars can be stored in memory under each of the 4 buttons.

2) Depress the ON button.

The lamp will light, indicating that the rhythm pattern can now be stored in memory.

3) Set the rhythm you want stored in memory.

You can store 16 x 4 (64) rhythm patterns, and 16 x 3 (48) Break Variation Patterns in the Electone's memory. The Introduction pattern can also be stored. Set the START button and monitor the rhythm to be stored in memory.

4) Press the RECORD button the same number of times as the number of bars you want stored in memory are displayed.

Press the RECORD button while watching the digital display. At first, <1> will be displayed. Each time you press the button, the digits will increase by one. These digits indicate the number of bars which will be stored in memory.

★ To store the BREAK VARIATION in memory, set the RECORD button while pressing the BREAK button. To store the Introduction in memory, set the RECORD button while the Introduction is playing.

5) To change the rhythm push the RECORD button to the ON position.

When the number of the bar for the new rhythm is shown on the Digital Display, the rhythm setting will be changed and entered into memory.

6) For just a required number of bars stored in memory, depress the END button.

Subsequently, the ON button lamp will turn off, indicating that playback is now possible.

★ When up to 64 bars have been stored in memory, <F> will be shown on the Digital Display. This indicates that no more bars can be stored in memory.

7) Push the START button again to the ON position.

Subsequently, the rhythm stored in memory will be played back from the first bar. When the playback arrives at the point where the END button was set, it will return again to the first bar, and this playback can be repeated indefinitely.

★ When 2 or more PROGRAM buttons have been used to store rhythms in memory and at playback the buttons are simultaneously turned on, there will be consecutive playback starting from the rhythm stored under the lowest numbered button. If all 4 buttons have been used to store rhythms in memory, up to 256 bars of consecutive playback is possible.

★ Once a rhythm is stored in memory, it will not be erased even when the power is turned off, until a new rhythm is stored using the same PROGRAM button.

■ BLANK

By using the BLANK button, a bar without any rhythm can be entered into a program. Depress the RECORD button while pressing the BLANK button.

■ BACK and FORWARD

These buttons are used to revise portions of the program as it is stored in memory. First, while watching the digital display, press the BACK button until the digits appear which indicate the bar number you want to revise. After putting the new rhythm into memory, press the FORWARD button until the original bar is reached.

Auto Functions

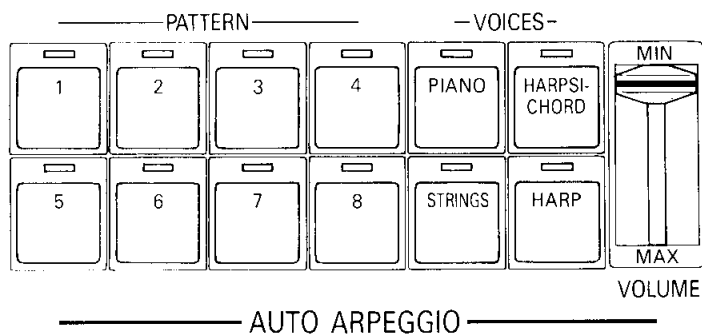

Auto Arpeggio

With this function an Arpeggio based on tones played on the lower keyboard can be automatically produced. When it is used as a background sound effect giving the impression of rippling waves, a more impressive performance can be enjoyed. Now, experiment with the Arpeggio sound.

1) Set the Rhythm. (Refer to Page 16.)

The Auto Arpeggio operates in synchronization with the Rhythm. Be sure to start it after setting the Rhythm. By setting the SYNCHRO START on, it is possible to simultaneously start the Rhythm and Arpeggio.

2) Select 1 of the 8 Pattern select buttons by depressing it.

The patterns which can be produced with these 8 buttons can be respectively altered according to the selected rhythm.

3) Select 1 of the 4 Voice select buttons by depressing it.

Arpeggio will be produced for the tone of the button which was set on.

4) Move the VOLUME slider downwards.

When Auto Arpeggio is not required, move the slider to the uppermost position.

When the electone has been set like this, if the lower keyboard is played, an Arpeggio based on the played tones will be automatically produced. If a chord is played on the lower keyboard, there will be a broader range for the Arpeggio. Change the setting to different patterns and tones, then compare each of them.

★ If the LOWER MEMORY button for the Auto Bass/Chord function is turned on, the Arpeggio will continue playing even after your fingers leave the Lower Keyboard. Moreover, if a SINGLE FINGER CHORD is used together with this function, Arpeggio based on the Auto Chord will be produced. (Refer to Pages 21, 22.)

★ When the Break Variation is operating, the Auto Arpeggio will temporarily stop.

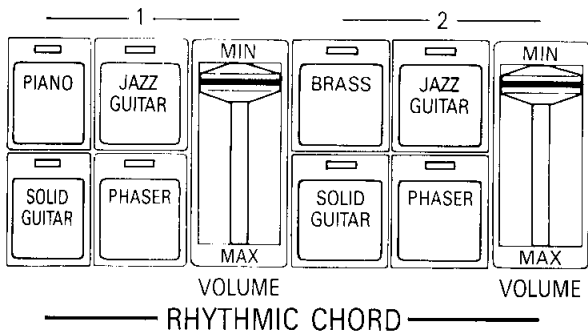

Rhythmic Chord

With this function a rhythm is automatically superimposed on the set tone just by playing the lower keyboard. When the Auto Bass/Chord function is used, the sound of the Rhythmic Chord is produced as the Auto Chord sound. (Refer to Page 21.) Now, experiment with this sound.

1) Set the Rhythm. (Refer to Page 16.)

Since the Rhythmic Chord operates in synchronization with the Rhythm, be sure to set the Rhythm before starting it.

2) Select the tone.

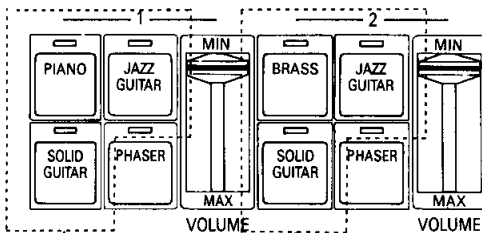

Set these one by one.

Group [1] and [2] each have 3 tone select buttons. Select one tone button from each group and set it on. Since the superimposition pattern of the rhythm is different for each voice group, two different patterns can be simultaneously produced. Moreover, the pattern will also be altered by the selected rhythm.

3) Move both of the VOLUME sliders downwards.

When you want only the pattern for one voice group to be produced, move the slider for the other group to the off position. When a Rhythmic Chord is required, move both sliders to the off position.

After the Electone has been set like this, when the lower keyboard is played the tone selected in Step 2 will automatically create the rhythm. Now, change the setting to other tones and listen to the difference.

■ PHASER

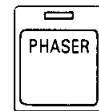

When this button is on, a Phaser effect is created where the tone for the Rhythmic Chord sound selected at that time gradually changes. Set the PHASER to create the effect you like.

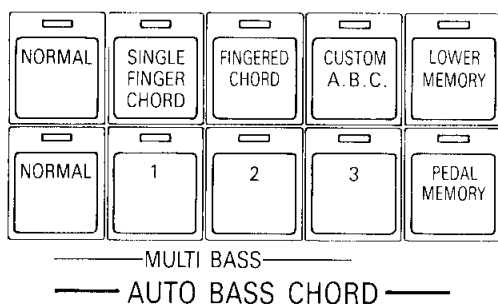

Auto Bass/Chord

Automatic accompaniment of chords and bass can be obtained with this function. There are 3 ways to use it: Single Finger Chord, Fingered Chord, and Custom A.B.C. Variations for the automatic bass accompaniment can be produced by using the Multi Bass. Now try and play an automatic accompaniment with the Single Finger Chord button.

[Single Finger Chord]

1) Set the Rhythm. (Refer to Page 16.)

After setting the Rhythm, make it start. If the SYNCHRO START has been pushed to the ON position, it will make the automatic accompaniment start together with the rhythm.

2) Push the SINGLE FINGER CHORD button to the ON position.



3) Set the tone for the Rhythmic Chord and the Lower Keyboard. (Refer to Pages 9, 20.)

4) Set the tone for the pedals. (Refer to Page 10.)

With the Electone set like this, if you press one key on the lower keyboard, a Major Chord based on the depressed key as the root note will be produced.

Only Rhythmic Chord tone will be superimposed on the Rhythm. Either the Rhythmic Chord or the Lower Keyboard Tones can be turned off.

Automatic bass accompaniment can also be produced for the sound from the pedals. It is determined according to the chord from the lower keyboard and the Rhythm.

★ The diagram below shows the relationship between the key which is pressed and the major chord which is produced. For the Single Finger Chord, the musical range of the subsequent accompaniment is the same for any musical range played on the lower keyboard.

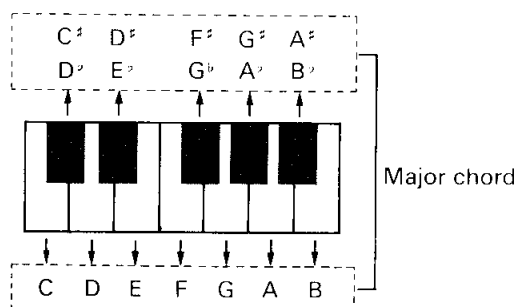

★ A Minor chord, Seventh chord, and Minor Seventh chord can all be produced by simultaneously pressing 2 or 3 keys of the lower keyboard.

Minor chord: Simultaneously press the key for the root note of the chord and any black key lower than the root note.

Seventh chord: Simultaneously press the key for the root note of the chord and any white key lower than the root note.

Minor Seventh chord: Simultaneously press the key for the root note of the chord and any black and white keys lower than the root note.

[Fingered Chord]

With this function there is automatic accompaniment based on the chord played on the lower keyboard. Set the FINGERED CHORD button, Rhythm, and tones, then play a chord on the lower keyboard.



Subsequently, the sound from the lower keyboard will be just like the chord which was played. Automatic bass accompaniment based on the chord from the lower keyboard can be obtained in synchronization with the rhythm for the sound from the pedals. You can also create automatic accompaniment based on a variety of other chords besides Major, Minor, and Seventh chords.

[Custom A.B.C.]

Separate automatic accompaniments for the pedals and the lower keyboard can be obtained with this function. Set the CUSTOM A.B.C. button, Rhythm, and tones. Then, while playing the chord on the lower keyboard, press the pedals.

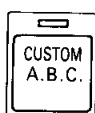

Subsequently, a chord corresponding to the keys played on the lower keyboard will be produced. Automatic bass accompaniment in synchronization with the Rhythm based on the notes played on the pedals can be obtained for sound from the pedals.

★ Rhythmic Chord sound will no longer be produced when the Rhythm is turned off. By using the Single Finger Chord button, other sounds from the lower keyboard will automatically become chords. Also, with the Single Finger Chord and Fingered Chord buttons, the sound from the pedals will be automatically produced as continuous sound.

■ MULTI BASS

The MULTI BASS buttons are used to select a pattern for the automatic accompaniment when any of the Single Finger Chord, Fingered Chord, or Custom A.B.C. buttons are used. After one of the 4 buttons is selected, the bass pattern can be altered by changing to another button. Moreover, the change in pattern is also affected by the selected rhythm.

■ LOWER MEMORY and PEDAL MEMORY

When these buttons are used, the automatic accompaniment will continue even after you have stopped playing the lower keyboard and pedals. The buttons can be used either individually or simultaneously. The LOWER MEMORY can be used together with the Rhythmic Chord, Auto Arpeggio, and Play Assist, even without setting the Auto Bass/Chord.

★ When the NORMAL button is on, the Single Finger Chord, Fingered Chord, and Custom A.B.C. functions are cancelled.

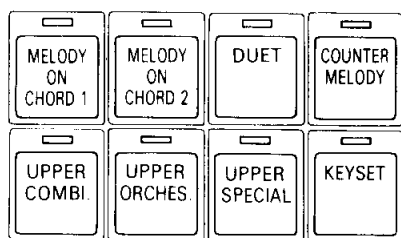

— PLAY ASSIST —

Play Assist

With this function a variety of supplementary sounds can be automatically added to the melody line which is played on the upper keyboard. There are four ways to use this function: Two types of Melody On Chord, Duet, and Counter Melody.

[Melody On Chord 1-2]

With this function, a harmony is added to the melody creating a deep sound. The notes that compose the chord played on the lower keyboard are picked up, and are automatically added as harmony beneath the melody line played on the upper keyboard.

- 1) Push the button for either **MELODY ON CHORD 1** or **MELODY ON CHORD 2** to the ON position.

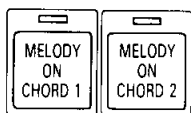

MELODY ON CHORD 1: When this button is selected, the automatically supplemented harmony is derived from a fairly different musical range than the one for the melody. The harmony sound is simultaneously produced up to the maximum of two notes.

MELODY ON CHORD 2: When this button is selected, the automatically supplemented harmony is derived from a musical range close to the one for the melody. The harmony sound is simultaneously produced up to the maximum of three notes.

- 2) Select the tone of the supplementary sound.

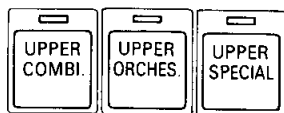

The tone group of the supplementary sound can be selected using these 3 buttons. Set the Tone Select button and VOLUME slider located on the front panel. It is possible to set 2 or more tone groups.

After setting the Electone like this, play chords on the lower keyboard and melodies on the upper keyboard. A lovely harmony will be added beneath the melody automatically.

[Duet]

A melody in 2 parts can be easily enjoyed with this function. The Electone reads the melody being played on the upper keyboard and the chord being played on the lower keyboard. It then automatically adds the correct note to the melody line as the supplementary sound.

- 1) Push on the **DUET** button to the ON position.



- 2) With the **KEY SET** button, have the key of the musical composition stored in memory.



On the lower keyboard, first play the 3 notes composing the tonic chord for the key of the musical composition to be performed. (For example the 3 notes composing the C major chord if the musical composition is in the key of C major; the 3 notes composing the A minor chord if the musical composition is in the key of A minor.) Turn on the KEY SET button while playing the Tonic chord. When the lamp flashes, it indicates that the key has been stored in memory.

- 3) Set the tone of the supplementary sound.

Set 1 or more of the 3 buttons on. (Refer to Step 2 for the Melody On Chord.)

When the Electone has been set like this, try playing a melody on the upper keyboard and a chord on the lower keyboard. A lovely melody in two parts will be automatically played matching the flow of the musical composition.

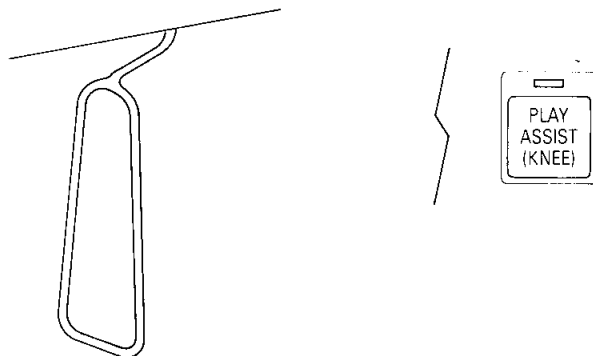

[Counter Melody]

With this function a counter melody can be obtained merely by playing a melody and chord. The Electone determines the correct note as the supplementary sound from the chord played on the lower keyboard. A counter melody is then automatically produced according to the progression of the melody and chord.

- 1) Push the **COUNTER MELODY** button to the **ON** position.



- 2) **Select the tone of the supplementary sound.**

Set on 1 or more of the 3 buttons. (Refer to Step 2 for the Melody On Chord.)

With the Electone set in this way, try playing a chord on the lower keyboard and a melody on the upper keyboard. A fine Counter Melody, at a different timing from the melody itself, will be produced.

■ Knee Lever control

By using the Knee Lever you can switch the Play Assist on or off.

First, turn on the PLAY ASSIST (KNEE) button located in the Sustain section, and then pull the Knee Lever down vertically. When you arrive at a point in a musical performance where you want to create supplementary sound, press the knee lever to the right. Supplementary sound will only be produced while you are pressing the lever.

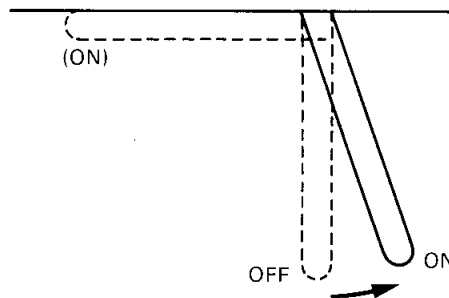

- ★ The Play Assist can be used together with the Auto Bass/Chord. If the Single Finger Chord is turned on, it is even easier to enjoy a performance accented with supplementary sound. Supplementary sound will continue even after your fingers leave the lower keyboard if both the Rhythm and Lower Memory are set on.

Registration Memory



By using the buttons located between the upper and lower keyboards, you can store in memory all the Registrations for the tones, effects, Rhythm, Auto functions, etc. Since the Registrations stored in memory can be recalled with a single button, settings can be altered with a single touch even during a performance.

[Procedure for storing a Registration in memory]

1) Set the Registration you want stored in memory onto the control panel.

You can store in memory the on/off for all the tones and effects, Rhythm types and tempo, on/off for the Auto functions, and all the slider positions. Moreover, both the PLAYER button for the Vibrato and PROGRAM button for the Rhythm Sequence Programmer can also be stored in memory if you set them.

2) While pressing down the MEMORY button (M.), push 1 of the buttons 1 - 8 to the ON position.

The lamp for the button you have set will flash. This indicates that the Registration has been stored in memory. Try storing your favorite Registrations in memory by using the remaining buttons.

- ★ The contents of the Registration in memory will not be erased even when the power is turned off, until a new Registration is stored in memory using the same button.
- ★ REVERB, MASTER VOLUME, REGISTRATION PACK, TREMOLO SPEED, and PITCH CONTROL have no relation with the memory.

[Procedure during a performance]

1) Set the registration to be used in the beginning of the performance onto the control panel and start playing.

Or you may set registrations with buttons 1-8 before the performance.

2) When you come to a point in the performance where you want to change to a registration in memory, depress the button for that registration to the ON position.

The lamp for the button you have depressed will flash. The control panel buttons will go on for the registration stored in memory, and the sliders will move to the correct positions which were set in memory. By following the same procedure, registrations stored in memory can be respectively obtained for all of the other 7 buttons when they depressed to the ON position.

- ★ Even when one of buttons 1-8 is on, registration can be changed on the control panel. At this time, the button lamp will go off but the contents in memory will not be erased. When you push the same button again, the portion you have altered on the control panel will return to its original status.



■ CANCEL (C.)



The last registration (excluding the registration changed by buttons 1-8) which is set on the panel, is constantly stored in memory. Therefore, after changing the registration by depressing buttons 1-8, the registration that was previously set will reappear on the panel whenever the CANCEL button is depressed.

Therefore, by setting a frequently used registration on the panel, it is possible to return to this any number of times by using the CANCEL button.

However, when the registration is changed on the panel while buttons 1-8 are on, the registration is stored in memory with the CANCEL button. In such a case, the registration obtained by depressing the CANCEL button is the registration after the change has been made, rather than the original one.

■ DISABLE (D.)



When this button is on, the setting for the Rhythm section and Auto functions remains the same, even when registrations are changed by depressing the C. button or buttons 1-8 to the ON position. Use this button when you only want to change the setting for the tones and effects.

■ SLIDER DRIVE



SLIDER DRIVE

When this button is on, the slider positions remain the same, even when the C. button or buttons 1-8 are depressed the ON position. Use this when the noise from the slider during operation bothers you.

■ RESET (R.)



When this button is on, the upper left button in each section will go on while the other buttons change to off position. All the sliders will go off or change to normal position. Use this button before beginning to set a new registration on the control panel.

■ Memory when Power is off

When the power is turned off, the status of the buttons and sliders, which were set on the control panel at that time, is automatically stored in memory. Even if the setting is changed while the power is off, when the power is turned on again the Electone will return to the registration which existed when the power was turned off.

There will be cases, though very rarely, when the memorized contents are changed or when the control panel will not function normally due to thunderbolts, etc. In such cases, turn the power switch OFF once. Then, while depressing the RESET button, turn the power switch ON. If, even after performing this operation, the Electone does not function normally, call a service person.

MEMORY READY

ERROR

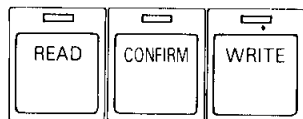

REGISTRATION PACK

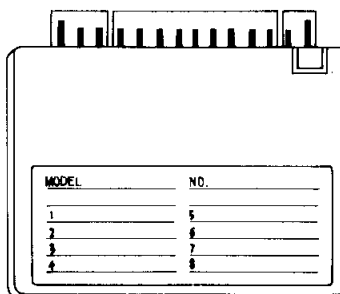
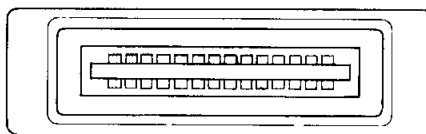

Registration Pack

The information memorized in the Electone by using buttons 1-8 can be transferred to the Registration Pack. Subsequently, you will be able to use the information transferred to the Registration Pack anytime.

[Operation (WRITE) for transferring information in the Electone's memory to the Registration Pack]

- 1) Store your favorite registrations in memory by using buttons 1 - 8 .
- 2) Insert the Registration Pack.

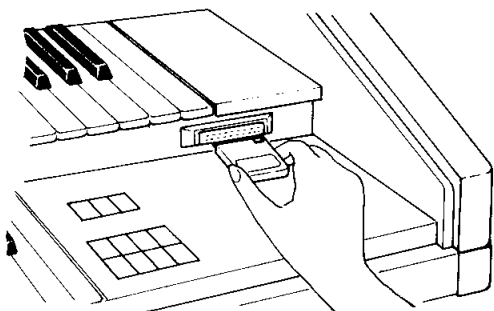

Firmly insert the Registration Pack straight into the slot as shown in the diagram. Subsequently, the MEMORY READY lamp will flash.

- ★ When it is not inserted correctly, the ERROR lamp will flash. Please reinsert the Registration Pack.
- 3) Depress the WRITE button while pressing the CONFIRM button.

Subsequently, the WRITE lamp will flash, indicating that the information in the Electone's memory has been transferred to the Registration Pack.

- ★ If the registration have already been entered on a number of Registration Packs, it will be convenient during a concert or other performance.
- ★ When new information is written into a Registration Pack, the previous information it contained will be erased.
- ★ If the tab on the side of the Pack is removed, it will prevent the operation. The information in such a pack will be protected.

[Operation (READ) for transferring the information contained in the Registration Pack into the Electone's memory]

- 1) Insert the Registration Pack.
- 2) Set on the READ button while pressing the CONFIRM button.
Subsequently the READ lamp will flash, this indicates that the information in the Registration Pack has been stored in memory for buttons 1-8. Now, even if you remove the pack, you will still obtain the registrations which were stored there.
- 3) By using buttons 1 - 8 experiment with a variety of registrations.

For information regarding buttons 1-8 refer to the instructions which were included with the Registration Pack.

- ★ When the procedure explained above has not been properly executed, the ERROR lamp will flash.
- ★ The contents stored in memory for buttons 1-8 until this time will be erased when the Registration Pack is read into the Electone.

The supplied Registration Pack contains a memory of 8 sets of preset tone information. Further, it is possible to memorize the Registration of your choice in this pack with the "WRITE" operation.

III. Useful Information about Using the Electone

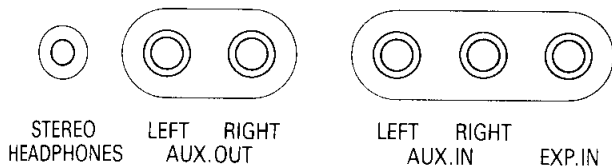

Accessory Jacks

●**STEREO HEADPHONES jack**

This jack is used for connecting the Stereo headphones. When the headphones are connected, there will be no sound from the Electone's speakers. This allows you the freedom to enjoy playing your Electone at any time without disturbing others. You can also use this jack for connecting monaural headphones.

●**AUX.OUT LEFT-RIGHT jacks**

These jacks are used to connect an amplifier or tone cabinet when a more powerful volume is needed for a performance. Also by connecting it with the line-in jack of a tape deck, you can record music produced by the Electone. If you want to record in stereo, both the LEFT and RIGHT jacks should be connected.

●**AUX.IN LEFT-RIGHT jacks**

These jacks are used to produce sound from a stereo or tapes through the Electone's speakers. By using these jacks you can perform together with music from records and tapes.

●**EXP.IN jack**

This jack is used for connecting a synthesizer or rhythm box. The volume of the attached equipment can be controlled with the Electone's expression pedal.

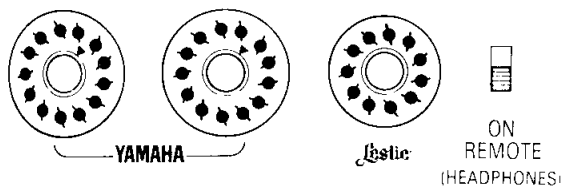

Tone Cabinet Connectors

●**YAMAHA connectors (13 pins)**

These are used for connecting the YAMAHA Tone Cabinets.

●**LESLIE connector (11 pins)**

This is used for connecting the LESLIE speaker.

●**REMOTE**

When the headphones are connected and this switch is turned on, there will be no sound from either the Electone or Tone Cabinet. Turn this switch off when you want to produce sound only from the Tone Cabinet and not from the Electone.

Looking After Your Electone

Always treat your Electone as a fine musical instrument. Use the following procedure to keep your Electone looking and sounding its best.

- 1) Make sure you are using the correct power voltage. If any changes are required, consult your Yamaha serviceman first.

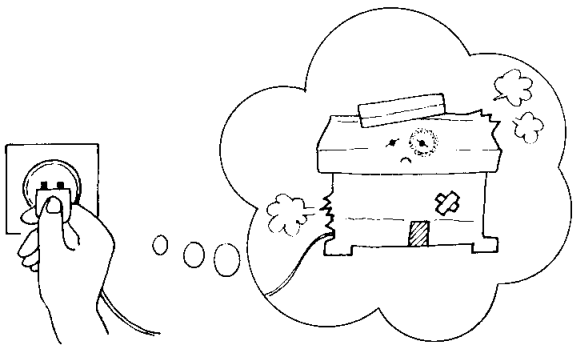

- 2) Your Electone does not have any user serviceable components. Rely only on qualified service technicians for repairs.

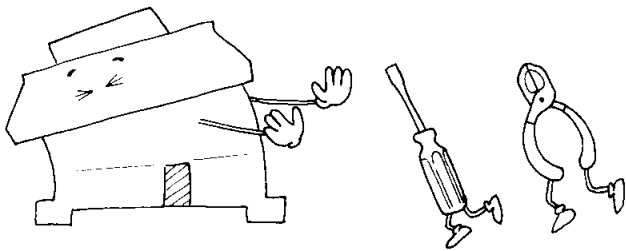

- 3) Always turn the power switch OFF after you have finished playing the Electone.

- 4) Clean the cabinet and keys of your Electone with a clean cloth moistened only with a mild detergent. Never use any strong chemical solvents such as thinner or alcohol.

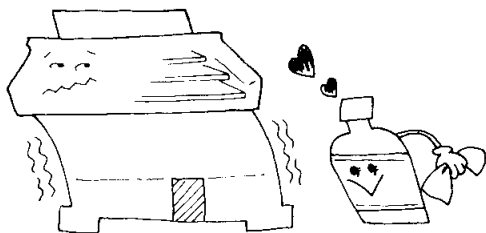

- 5) Keep your Electone away from direct sunlight, excess humidity and heat in order to preserve the cabinet finish and joints.

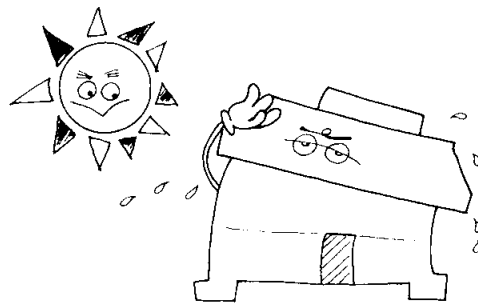

- 6) Do not hit or scratch the cabinet with any hard objects.



- 7) Do not set heavy objects on the rolltop fallboard.

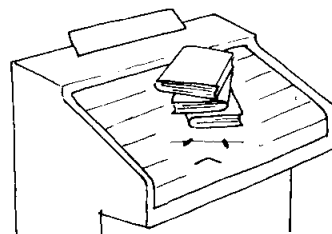

- 8) Never put any objects made of vinyl on your Electone, since the finish reacts chemically to vinyl.

- 9) Remove the electric plug from the power outlet when you will not be using the Electone for some time or if there is any thunder.

Troubleshooting and Misleading Phenomena

Phenomenon	Cause	Solution
Radio frequency interference, static noise	<ol style="list-style-type: none"> (1) Noise is caused when home appliances such as refrigerators and washing machines go on and off. (2) May be caused by the failure of a neon sign in the neighborhood, an electric drill, etc. 	<ol style="list-style-type: none"> (1) Use a power outlet located farthest from the appliance you suspect is causing the problem. (2) If possible, have the neon sign repaired. (3) If you cannot discover the source of the noise, phone your local Yamaha dealer.
TV or radio reception is adversely affected when the Electone is turned on.	The radio or TV set is being used in the immediate vicinity of the Electone.	Move the radio or TV set as far away from the Electone as possible. Upgrade the TV or radio antenna system.
Occasional interference from radio or TV broadcasts.	A broadcasting station with a high signal strength or an amateur radio station is located nearby.	Try to identify the type of station: TV, FM radio, AM radio, "ham" operator, CB operator, etc.
Sound resonance or vibration	Since the Electone produces a continuous sound, the surrounding cupboards, window panes and other objects may resonate.	<ol style="list-style-type: none"> (1) Turn down the sound volume. (2) If possible, remove the resonating objects.
The pitch feels high when using the pedals and low when using the treble section for the upper and lower keyboards.	This seems particularly so in comparison to a piano. However, the overtone construction of a piano is complex, particularly in the treble and bass. For a piano, melodies are not formed with the actual direct vibrations but when the overtones are heard. The formation of melodies is exactly the opposite for the Electone.	
A rhythm different from the one you set is produced.	The PROGRAM buttons for the Rhythm Sequence Programmer are on.	Keep the PROGRAM buttons off when you are not using the Rhythm Sequence Programmer.
Sound from the lower keyboard or pedals continues playing.	The LOWER MEMORY button for the Auto Bass/Chord section or the PEDAL MEMORY button are on for using the Rhythm.	Set off the LOWER MEMORY or the PEDAL MEMORY buttons.
The automatic supplementary sound for the Play Assist is not produced even when the upper and lower keyboards are played.	<ol style="list-style-type: none"> (1) All the tone select buttons for the supplementary sound are off. (2) The lowest musical range of the upper keyboard is being played. 	<ol style="list-style-type: none"> (1) Make sure that 1 or several of these buttons are set on, and that the VOLUME slider is moved downwards. (2) There may be cases when supplementary sound is not produced for the lowest musical range of the upper keyboard.
When calling out a memorized registration, the Rhythm and Auto function settings do not change.	Because the DISABLE button is pushed to the ON position.	When you wish to change all the registrations, push the DISABLE button to the OFF position.

Specifications/Technische Daten Caractéristiques Techniques/Especificaciones

Italics: FS-70/Kursiv: FS-70/Italiques: FS-70/Itálicas: FS-70

KEYBOARDS

Solo: 37 keys $c_1 \sim c_4$ (3 octaves)
Upper: 49 keys $c \sim c_4$ (4 octaves)
Lower: 49 keys $C \sim c_3$ (4 octaves)
Pedals: 13 keys $C \sim c$ (1 octave)

COMBINATION

Upper: Combi. Lever, Memory 1 · 2 · 3,
Preset 1 · 2 · 3 · 4, Volume,
(Levers) 16', 8', 5 1/3', 4', 2 2/3', 2', 1',
Attack 4' · 2 2/3' · 2', Attack Length
Lower: Combi. Lever, Memory 1 · 2 · 3,
Preset 1 · 2 · 3 · 4, Volume,
(Levers) 8', 4', 2 2/3', 2'
Pedals: Combi. Lever, Memory, Preset 1 · 2, Volume,
(Levers) 16', 8'

ORCHESTRA

Upper: Strings 1, Strings 2, Strings 3, Brass 1, Brass 2,
Reed 1, Reed 2, Vocal, Spice 1, Spice 2,
(Controls) Preset Vibrato, Touch Tone, Volume
Lower: Strings 1, Strings 2, Brass 1, Brass 2, Reed,
Vocal, Spice 1, Spice 2,
(Controls) Preset Vibrato, Touch Tone, Volume

SPECIAL PRESETS

Upper: Piano, Harpsichord, Celesta, Vibraphone,
Marimba, Mandlin, Banjo, Jazz Guitar, Brass 1,
Brass 2, Cosmic,
(Controls) Touch Tone, Volume
Lower: Piano, Electric Piano, Harpsichord, Harp, Acoustic
Guitar, Jazz Guitar, Brass 1, Brass 2, Cosmic,
(Controls) Touch Tone, Volume

CUSTOM VOICES

Upper/Lower: Flute, Oboe, Clarinet, Saxophone, Trumpet,
Trombone, Violin, Jazz Guitar, Cosmic 1,
Cosmic 2, Cosmic 3,
(Controls) Preset Vibrato, Touch Vibrato, Touch
Tone, Volume
Pedals: Contra Bass 1, Contra Bass 2, Contra Bass 3,
Tuba, Electric Bass 1, Electric Bass 2,
Electric Bass 3, Vocal,
(Controls) Brilliance, Volume

SOLO

*Piccolo, Flute, Oboe, Clarinet, Saxophone, Trumpet 1,
Trumpet 2, Horn, Trombone, Violin, Jazz Guitar,
Harmonica, Cosmic 1, Cosmic 2,
(Controls) Detune, Coupler, Transposition (Down, Normal,
Up), Preset Vibrato, Touch Vibrato, Touch Tone, Brilliance,
Volume, Slide Control*

ENSEMBLE

Upper Combi., Upper Orches., Upper Special, Upper
Custom, Lower Combi., Lower Orches., Lower Special,
Lower Custom

EFFECTS · CONTROLS

Sustain: (Switches) Upper Sustain (Knee), Lower Sustain
(Knee), Pedal Sustain,
(Controls) Upper, Lower, Pedal,
Symphonic: Celeste, Symphonic, Upper Combi., Upper
Orches., Lower Combi., Lower Orches.,
Tremolo: Chorus, Tremolo, Upper Combi., Upper Orches.,
Lower Combi., Lower Orches., Tremolo Speed
control,
Reverb, Glide (Foot Switch control),
(Combination) Program Set, Response Fast, Timbre
Variation,
Vibrato Presetter: Set, Lever, Player, Preset,
(Controls) Touch Depth, Delay, Depth, Speed,
(Indicator) *Solo*, Upper Orches., U/L Custom,
Lower Orches., Pedals

AUTO RHYTHM

Pattern Selectors: March, Waltz, Ballad, Swing, Bounce,
Slow Rock, 8 Beat 1, 8 Beat 2, Tango, Latin 1,
Latin 2, Bossanova, Samba, Latin Rock, Disco, 16
Beat, Variation 1 · 2 · 3 · 4,
Break Variation: 1 · 2 · 3 (16x3 patterns), Break, Break
Variation (Foot Switch control)
Auto Variation: Normal, 4Bar, 8Bar, 16Bar,
Rhythm Sequence Programmer: Program 1 · 2 · 3 · 4
(64Bars x 4), On, Record, Blank, End, Back,
Forward,
Digital Display: Tempo, Bar/Beat,
Controls: Synchro Start, Start, Tempo, Volume, Balance,
Tempo Indicator Lamp, Rhythm Stop (Foot
Switch control)

AUTO ARPEGGIO

Pattern Selectors: 1 · 2 · 3 · 4 · 5 · 6 · 7 · 8
(16x8 patterns),
Voice Selectors: Piano, Harpsichord, Strings, Harp,
Volume (control)

RHYTHMIC CHORD

Pattern 1: Piano, Jazz Guitar, Solid Guitar, Phaser (effect),
Volume (control),
Pattern 2: Brass, Jazz Guitar, Solid Guitar, Phaser (effect),
Volume (control),

AUTO BASS/CHORD

Mode Selectors: Normal, Single Finger Chord, Fingered
Chord, Custom A.B.C.,
Multi Bass (Normal, 1, 2, 3), Lower Memory, Pedal Memory

PLAY ASSIST

Functions: Melody On Chord 1, Melody On Chord 2, Duet,
Counter Melody,
Controls: Key Set (Duet control), Play Assist (Knee Lever
control),
Voice Selectors: Upper Combi., Upper Orches., Upper
Special

REGISTRATION MEMORY

Preset buttons: 1 · 2 · 3 · 4 · 5 · 6 · 7 · 8,
Controls: Memory, Cancel, Disable, Slider Drive,
Registration Pack: Read, Confirm, Write,
(Indicator) Memory Ready, Error

MAIN CONTROLS

Manual Balance, Master Volume, Expression Pedal, Panel
Light switch, Reset, Knee Lever, Foot Switch, Power
Switch, Power Light, Pitch Control

OTHER FITTING

Stereo Headphones jack, Aux. Out Left-Right jacks, Aux. In
Left-Right jacks, Exp. In jack, Yamaha Tone Cabinet
connectors (13 pins · 13 pins), Leslie Tone Cabinet
connector (11 pins), Remote (Headphones), Registration
Pack, *Panel Light*, Music Rest, Matching Bench, Rolltop
Fallbaord

MAIN AMPLIFIER

Center: 90W(rms), Left: 60W(rms), Right: 60W(rms)

SPEAKERS

Center: Woofer 30cm (12"), Mid-range 20cm (8"),
Tweeter 5cm (2"),
Left: Mid-range 20cm (8"), Tweeter 5cm (2"),
Right: Mid-range 20cm (8"), Tweeter 5cm (2")

CIRCUITRY

Solid State (incl. LSIs and ICs)
Power Consumption: See Electone nameplate
Power Source: 50/60Hz AC

DIMENSIONS

Cabinet (FS-70): 117(W) x 75(D) x 110(H)cm
(46" x 29 1/2" x 43 1/2")
Cabinet (FS-50): 116(W) x 69(D) x 106(H)cm
(45 3/4" x 26 1/4" x 41 1/2")
Bench: 66(W) x 32(D) x 56(H)cm (26" x 12 1/2" x 22")

WEIGHTS

Cabinets (FS-70): 132kg (291 lbs.)
Cabinets (FS-50): 122kg (269 lbs.)
Bench: 7.5kg (16.5 lbs.)

FINISH

Real American Walnut

* Specifications subject to change without notice.

[Where to find the Name plate]

[Hire ist das Typenschild angebracht]

[Emplacement de la plaque signalétique]

[Dónde localizar el membrete]

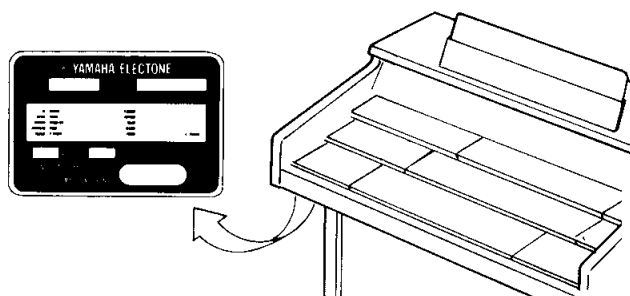

Special Instructions for British Standard Model

As the colours of the wires in the mains lead of this apparatus may not correspond with the coloured markings identifying the terminals in your plug, proceed as follows.

The wire which is coloured BLUE must be connected to the terminal which is marked with the letter N or coloured BLACK.

The wire which is coloured BROWN must be connected to the terminal which is marked with the letter L or coloured RED.

IMPORTANT

THE WIRES IN THIS MAINS LEAD ARE COLOURED IN ACCORDANCE WITH THE FOLLOWING CODE:

BLUE: NEUTRAL
BROWN: LIVE

SINCE 1887



YAMAHA

NIPPON GAKKI CO., LTD. HAMAMATSU, JAPAN
ELECTONE is a registered trademark of Nippon Gakki Co., Ltd.