

ブロックダイアグラム

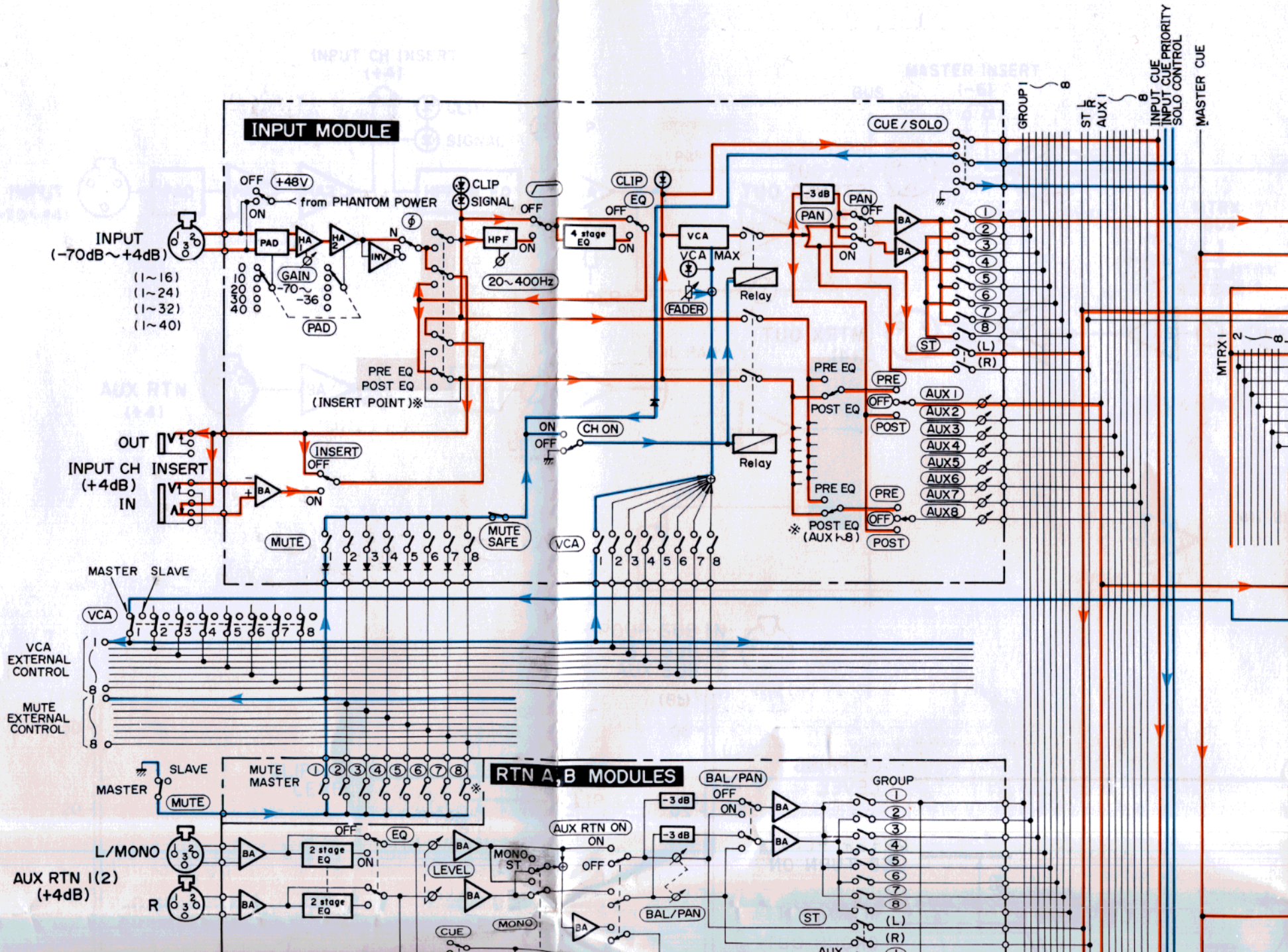

AUX RTN 1(2)
(+4dB)

L/MONO
AUX RTN 3(4)
(+4dB)

RTN A MODULE	AUX RETURN 1,3 MUTE MASTER
RTN B MODULE	AUX RETURN 2,4

TALKBACK IN

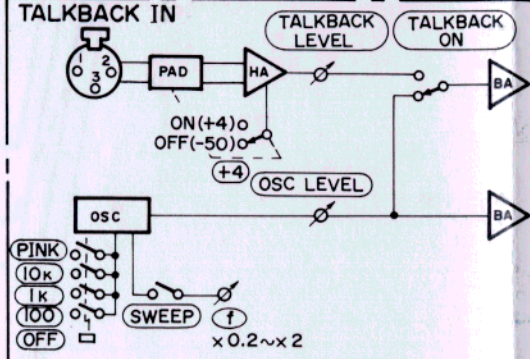

- 内部切替スイッチ
- オーディオ信号
- コントロール信号

RTN 3

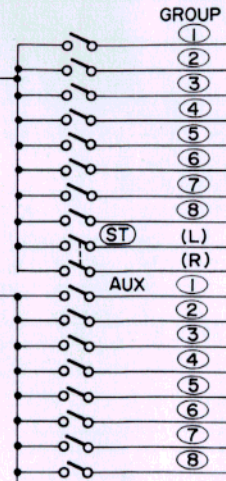

CUE/SOLO CONTROL

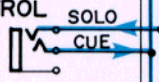

TB OUT

OSC OUT

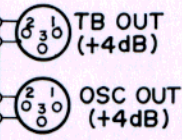

COMM MODULE

RTN CUE L
RTN CUE R

CO
(+)

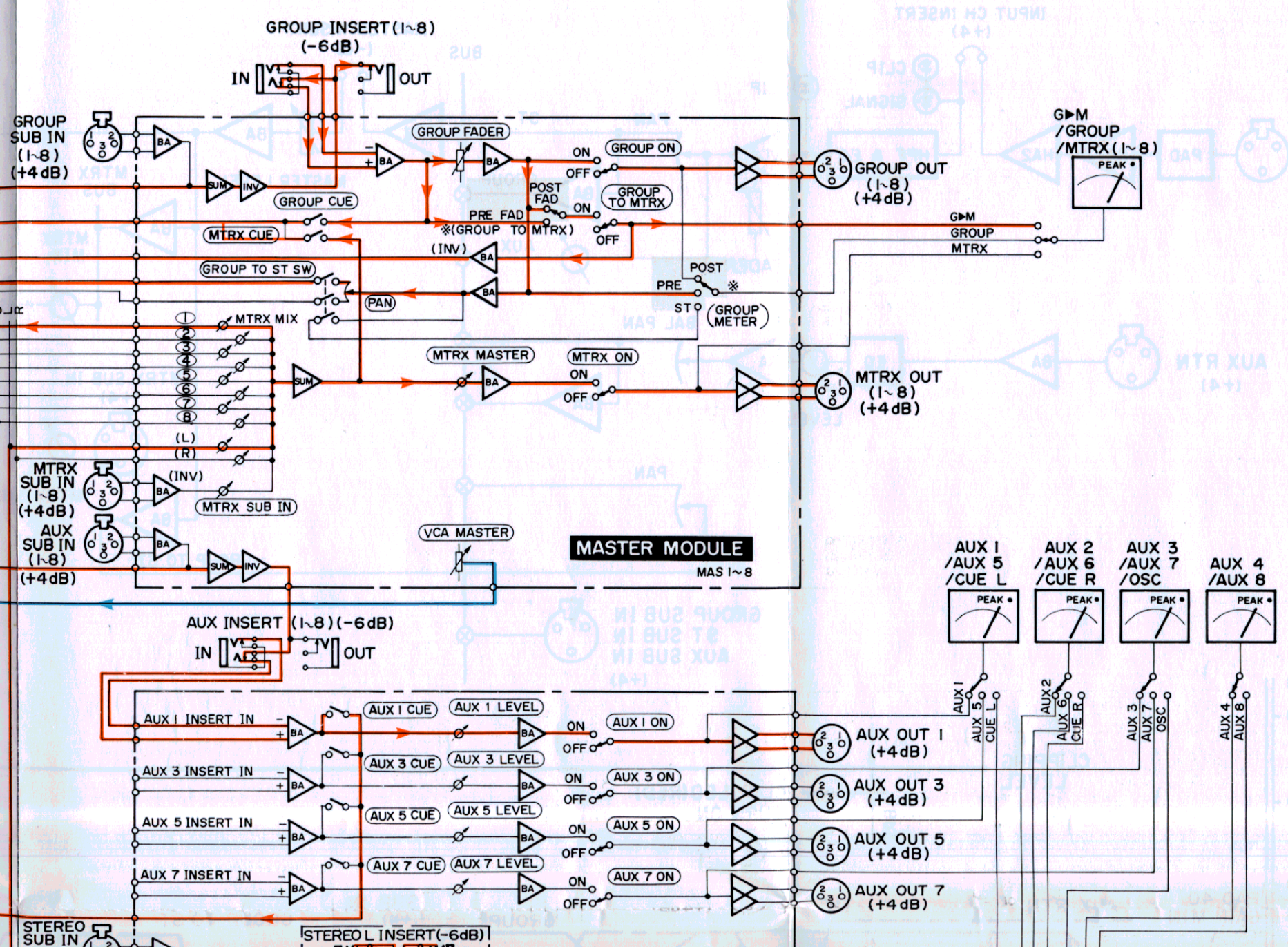

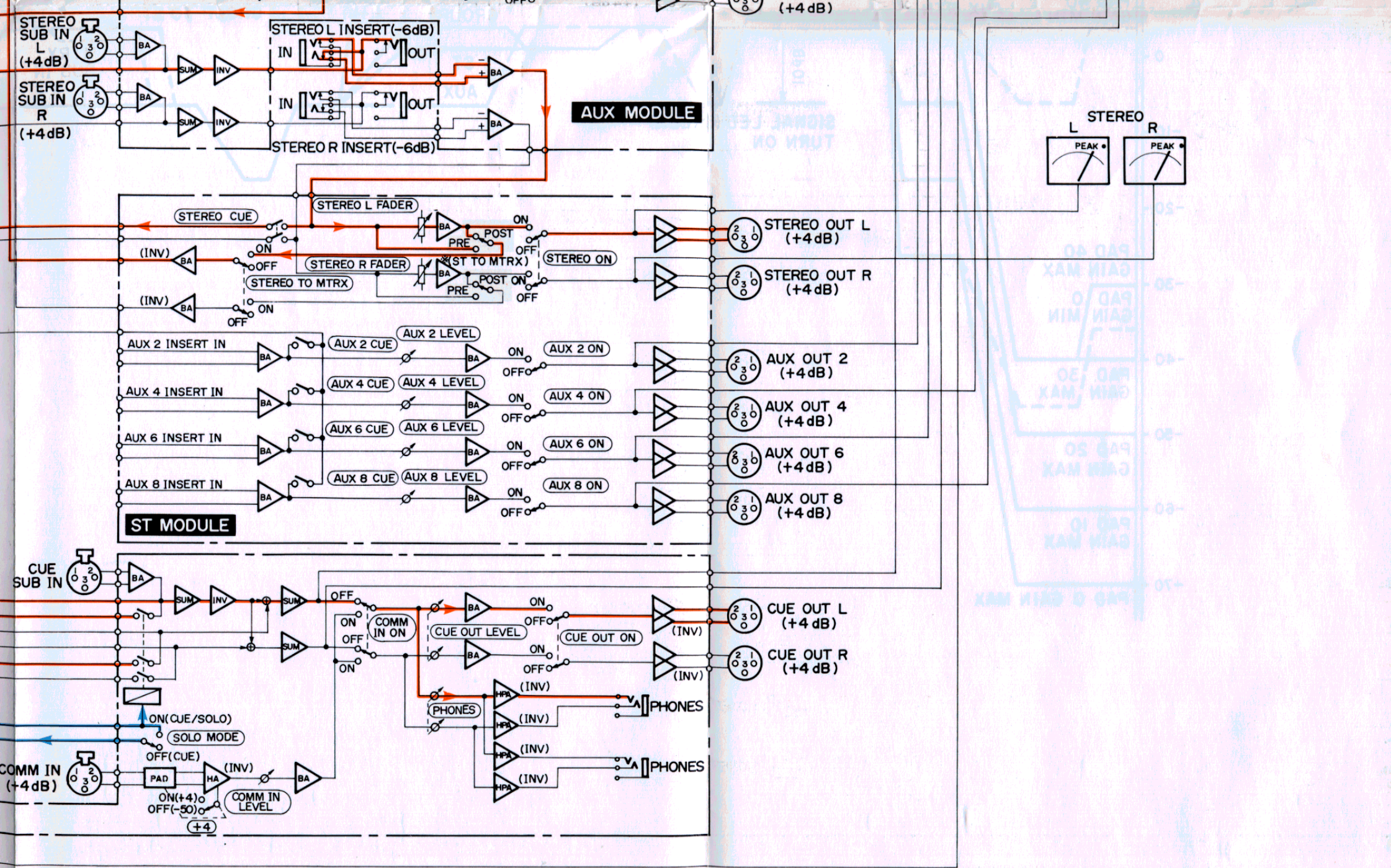

レベルダイアグラム

