

DIGITAL KEYBOARD

REFERENCE MANUAL

— PSR-E583

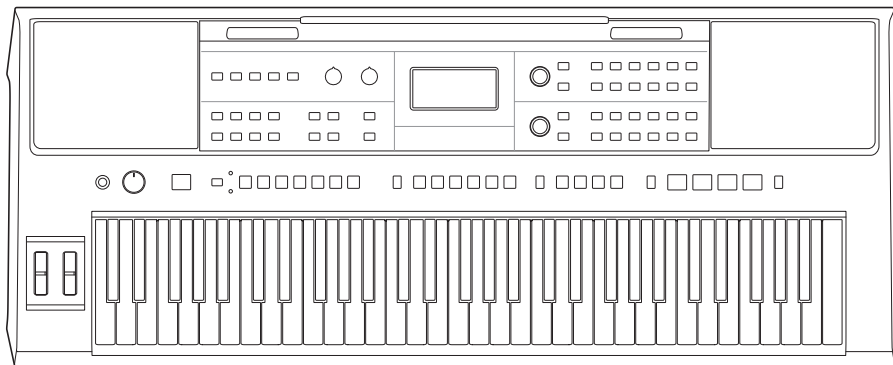

— PSR-E483

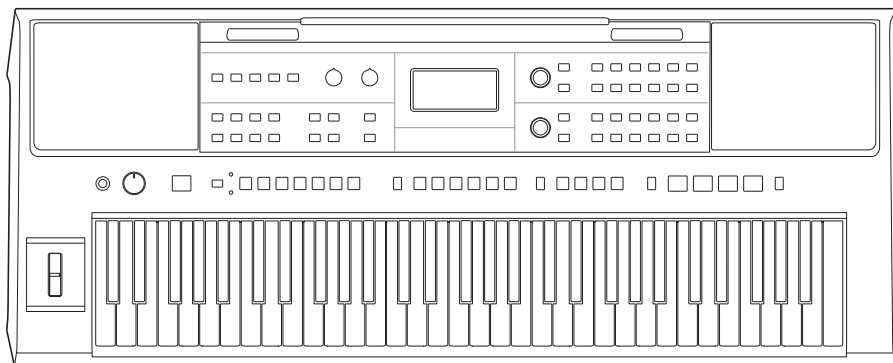

About the Manuals

The following documents and instructional materials are available for this instrument.

■ Supplied with the Instrument

● Owner's Manual

This provides information on the basic functions of this instrument as well as "PRECAUTIONS" that must be read before using the instrument. Read this document first.

■ Available on the Website

● Reference Manual (this book)

This provides detailed information on all functions of this instrument.

● Data List

This provides lists of Voices, Songs, Styles, etc., built into this instrument as well as information about MIDI.

● Smart Device Connection Manual

This provides instructions on connecting this instrument to smart devices, such as smartphones and tablets.

● MIDI Basics

This contains basic explanations about what MIDI is and can do.

The manuals listed above can be found on the following Yamaha website.



PSR-E583/PSR-E483 download page

<https://manual.yamaha.com/mi/rt/psr-e483/downloads/>

Downloading the Song Data and Song Book

Song data that can be played back on this instrument as well as the Song Book, which contains the sheet music for the song data, can be downloaded free of charge from the above website.

Feel free to use them.



Song Data

Includes song (MIDI) data that can be played back on this instrument.



Song Book

Contains the sheet music for the song data.

■ Video Manuals

These are specially prepared video manuals that show how to use this instrument.





To see the video manuals, visit the following Yamaha website.

<https://manual.yamaha.com/mi/rt/psr-e483/videos/>

Conventions

In this document, various types of precautions and other important information are highlighted as follows.

 WARNING	Indicates a risk of serious injury or death.
 CAUTION	Indicates a risk of injury.
NOTICE	Indicates a risk of product failure, damage or malfunction as well as data loss.
 NOTE	Indicates additional information that may be useful.

Information

- The illustrations and displays in this Reference Manual are for instructional purposes only.
- Unless indicated otherwise, the illustrations and displays as shown in this manual are based on the PSR-E583.
- Windows is a registered trademark of Microsoft Corporation in the United States and other countries.
- Mac is a trademark of Apple Inc., registered in the U.S. and other countries.
- USB Type-C™ and USB-C™ are registered trademarks of USB Implementers Forum.
- The company names and product names in this manual are trademarks or registered trademarks of their respective companies.

Compatible Formats and Functions



GM System Level 1

“GM System Level 1” is an addition to the MIDI standard which ensures that any GM-compatible music data can be accurately played by any GM-compatible tone generator, regardless of manufacturer. The GM mark is affixed to all software and hardware products that support GM System Level.



XGlite

As its name implies, “XGlite” is a simplified version of Yamaha’s high-quality XG tone generation format. Naturally, you can play back any XG song data using an XGlite tone generator. However, keep in mind that some songs may play back differently compared to the original data, due to the reduced set of control parameters and effects.



Style File Format (SFF)

The Style File Format is Yamaha’s original style file format which uses a unique conversion system to provide high-quality automatic accompaniment based on a wide range of chord types.

Table of Contents

About the Manuals	2	Selecting a Chorus Type	31
Conventions	3	Selecting a Master EQ Setting To Achieve a Desired Sound.....	32
Information	3	Using the Pitch Bend Wheel	32
Compatible Formats and Functions	3	Using the Modulation Wheel (PSR-E583 only).....	32
Setting Up	6	Playing with Rhythm and Auto Accompaniment (Styles)	33
Power Requirements	6	About the Auto Accompaniment Function (Style)	33
Turning the Instrument On/Off.....	8	Specifying the Chords Yourself	34
Auto Power Off Function	8	Selecting How Chords Are Specified When Playing Them Yourself (Fingering Type)	36
Using the Music Rest	8	Specifying the Style Key (Auto Chord Play/Smart Chord).....	37
Panel Controls and Terminals	9	Specifying Chords Automatically (Auto Chord Play)...	38
Basic Operations and Display Information	13	Using Style Playback Variations	41
Basic Operations.....	13	Using Style Sync Stop.....	42
Display Information.....	14	Turning Each Style Track On/Off.....	42
Using the Common Functions	16	Adjusting the Volume of Each Style Track Separately ...	42
Changing the Tempo.....	16	Changing the Voice Assignments of the Style Parts (Style Revoicing)	43
Using the Metronome.....	16	Playing Chords with the Multi Finger Setting.....	44
Boosting the Overall Volume of the Instrument (Mega Boost)	18	Chords Specified with the Smart Chord Setting.....	45
Changing the Touch Sensitivity of the Keyboard (Touch Response).....	18	Loading Style Files from External Devices.....	46
Changing the Pitch of the Instrument (Transpose) ...	19	Changing the Sound with the Knobs	47
Finely Adjusting the Pitch of the Instrument (Tuning)...	19	Using the Knobs.....	47
Playing a Variety of Voices (Instrument Sounds)	20	Specifying Knob Settings	48
Selecting a Main Voice.....	20	Functions Assignable to the Knobs.....	49
Playing with the Sound of a Grand Piano.....	20	Specifying Scale Tuning (Temperament) Settings	50
Calling Up Optimum Panel Settings —One-Touch Setting (OTS)	20	Selecting a Preset Temperament	50
Adding a Layer - Dual Voice	21	Selecting the Base Note for the Temperament	50
Playing Different Voices with the Left and Right Hands (Split Voice)	22	Tuning Each Note to Create an Original Scale	51
Changing Voice Settings.....	23	Playing Back Songs (MIDI Data) or Audio Files	52
Adding Articulation Effects.....	24	Playing Back a Demo Song	53
Using the Harmony Function.....	25	Playing Back a Song (MIDI Data).....	53
Using the Arpeggio Function	26	Playing Back an Audio File from a USB Flash Drive ...	54
Synchronizing an Arpeggio to Style/Song Playback (Arpeggio Quantize).....	27	Song/Audio File Transport Controls: Fast Forward, Fast Reverse, and Pause	55
Maintaining Arpeggio Playback via the Foot Switch (Arpeggio Hold)	27	Playing a Specified Section of a Song Repeatedly (A-B Repeat).....	55
Adding Effects to Performance and Playback	28	Playing a Recorded Phrase (User Song) Repeatedly.....	56
Adding DSP Effects.....	28	Changing the Melody Voice of a Song.....	56
Adding Motion Effects.....	30	Muting Each Track Separately.....	57
Selecting a Reverb Type	31	Adjusting the Volume of Each Song Track Separately...	57

Connecting and Using a Microphone 58

- Connecting a Microphone.....58
- Disconnecting the Microphone59

Recording Your Performance 60

- Methods for Recording Onto This Instrument60
- Recording a Performance
 - as a New User Song (MIDI Recording).....61
- Recording Each Track (Part) Separately63
- Specifying the Number of Measures To Record64
- Deleting a User Song (Song Clear).....65
- Clearing a Specified Track
 - from a User Song (Track Clear)65
- Saving a User Song as a MIDI File
 - onto a USB Flash Drive66
- Deleting a MIDI File from a USB Flash Drive67
- Recording a Performance as an Audio File
 - onto a USB Flash Drive68
- Deleting an Audio File from a USB Flash Drive.....69

Saving/Recalling Your Favorite Settings (Registration Memory) 70

- Recalling Settings Saved to Registration Memory ...70
- Saving Panel Settings to Registration Memory71
- Specifying Panel Settings To Be Maintained Across Registration Memory Changes (Freeze)72

Using the Quick Sampling Function 73

- Playing Back a Sample73
- Looping a Sample73
- Playing Back Samples in Sync with Style/Song Playback (Sampling Sync Playback)....74
- Getting Ready for Sampling75
- Sampling External Audio.....75
- Restoring the Default Samples.....77
- Saving a Sample onto USB Flash Drive78
- Importing WAV File from USB Flash Drive as a Sample79
- Loading a Sample from USB Flash Drive.....80
- Deleting a Sample From USB Flash Drive81

Using the Looper Function 82

- Recording a Phrase.....82
- Overdubbing83
- Loop Playback of a Recorded Phrase84
- Loop Playback of a Phrase in Sync with Style/Song Playback (Sync Playback).....84
- Deleting a Recorded Phrase85
- Saving a Phrase Recorded Using Looper Function onto USB flash drive86

- Loading a Looper File from USB Flash Drive87
- Deleting a Looper File from USB Flash Drive.....88

Connecting a USB Flash Drive 89

- File Operations Related to USB Flash Drives90
- Formatting a USB Flash Drive92
- Saving User Data to USB Flash Drive93
- Loading a User File from USB Flash Drive.....94
- Deleting a User File from USB Flash Drive.....95
- List of Error Messages Related
 - File Control Operations96

Connecting Other Devices 97

- Connecting Headphones97
- Connecting a Foot Switch97
- Connecting a Foot Controller (PSR-E583 Only)97
- Playing Sound over External Speakers98
- Playing an External Audio Device
 - over the Built-in Speakers98
- Using the Melody Suppressor.....99
- Connecting to a Computer99
- Sending/Receiving Data Between Computer/Smart Device and Instrument.....102
- Using Apps103

Function Settings 104

- Basic Procedure for the Function Settings.....104

Backup and Initialization 114

- Data and Settings That Are Backed Up114
- Initializing the Instrument.....114

Block Diagram 115

Troubleshooting 116

Index 118

Setting Up

Power Requirements

This instrument can be powered by either an AC adaptor or batteries; however, Yamaha recommends using an AC adaptor whenever possible.

NOTICE

- When connecting a USB flash drive, be sure to use an AC adaptor. Battery power may not last through these crucial operations.

Using an AC Adaptor

Connect the AC adaptor in the order shown in the illustration.

PSR-E583

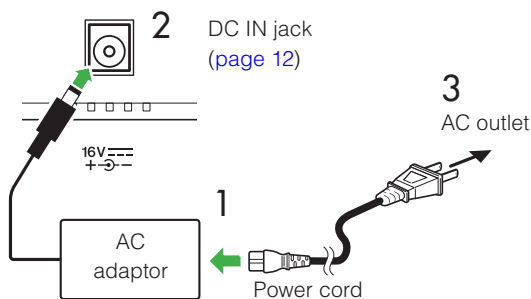

PSR-E483

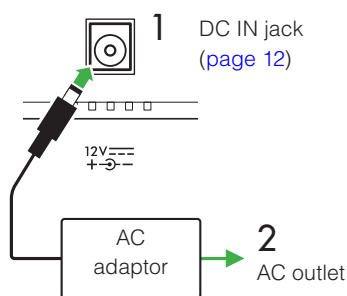

To disconnect the AC adaptor, reverse the procedure.

! WARNING

- Use only the included or specified AC adaptor. Using the wrong AC adaptor may result in damage, overheating or fire. In those cases, be aware that we may not be able to provide a guarantee, even if this occurs within the warranty period.
- When setting up the instrument, make sure that the AC outlet being used is easily accessible. If a problem or malfunction occurs, immediately turn the instrument off and remove the plug from the AC outlet.

! WARNING

- If the AC adaptor has a removable plug, be sure to keep the plug attached to the AC adaptor. Inserting only the plug into an AC outlet may cause electric shock or fire.
- If the plug comes off, be careful not to touch the inner metal parts, and fully insert the plug until it snaps into place. Also be careful that no dust or foreign matter gets between the AC adaptor and plug. Otherwise, electric shock, short circuit or damage may result.

When using the AC adaptor with a removable plug

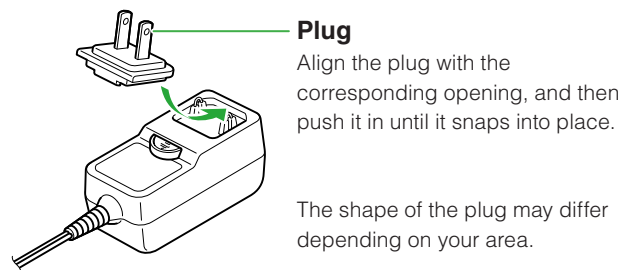

Using Batteries

This instrument can use AA alkaline (LR6), manganese (R6) or Ni-MH rechargeable (HR6) batteries. Alkaline batteries or Ni-MH rechargeable batteries are recommended for this instrument since other types may not provide enough power in certain situations.

NOTICE

- When using Ni-MH batteries, follow the instructions included with the batteries.

- 1 Make sure that the instrument is turned off.
- 2 Open the battery compartment cover, located on the instrument's bottom panel.

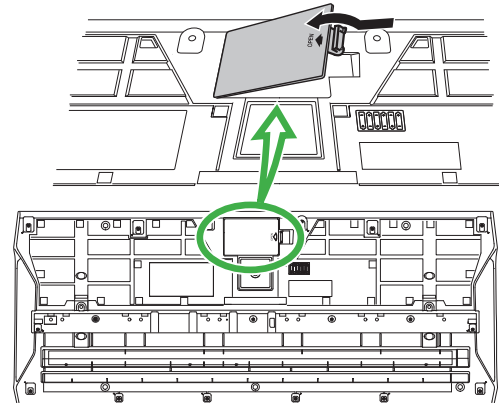

3 Insert six new batteries, making sure that they are correctly oriented, as illustrated.

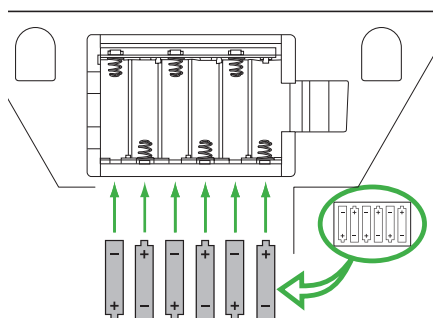

4 Reinstall the compartment cover, making sure that it locks firmly into place.

5 Change the battery type setting, according to the type being used. (Refer to the following.)

NOTICE

- Do not connect or disconnect the DC plug of the AC adaptor with batteries installed and the instrument turned on. Otherwise, the instrument will be temporarily turned off, and any data being recorded or transferred will be lost.
- Do not delay replacing the batteries. When the battery level is low, the volume may decrease, the sound quality may deteriorate, or the instrument may stop functioning properly.

NOTE

- This instrument cannot charge the batteries. Use only the specified charger for charging the batteries.
- Power will be automatically drawn from the AC adaptor if an AC adaptor is connected, even with batteries installed in the instrument.

Setting the Battery Type

Change the battery type setting, according to the type (non-rechargeable or rechargeable) being used. After inserting the batteries, change the setting in the Function setting display (page 113, [Function 080](#) (PSR-E583)/[Function 079](#) (PSR-E483)).

Default setting: Alkaline

Alkaline	Alkaline or manganese batteries
Ni-MH	Rechargeable nickel metal hydride batteries

NOTICE

- An incorrect battery type setting may shorten the battery life. Be sure to select the correct battery type.

Checking the Power Status

The display shows whether batteries or the AC adaptor is the power source.

When batteries are being used, the remaining battery power indicator (in the upper right of the display) shows the battery level.

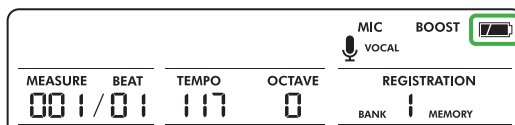

NOTE

- The battery indicator is not shown if the AC adaptor is plugged into an AC outlet, even with batteries installed.

Remaining Battery Power Indicator

	Indicates no power remaining. The instrument will be turned off immediately.
	Indicates that remaining power is insufficient for operation. Before the batteries run out of power, replace them all with new ones or (when using rechargeables) fully recharged ones. When the battery level is low, the volume may decrease, the sound quality may deteriorate, or the instrument may stop functioning properly.
	Indicates that the remaining power is sufficient.

Turning the Instrument On/Off

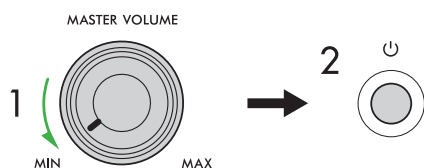

- 1 Turn the [MASTER VOLUME] control fully counterclockwise, to “MIN.”
- 2 Press the [⏻] (Standby/On) switch to turn on the instrument.
When the instrument is turned on, the display comes on.
- 3 While playing the keyboard, adjust the overall volume of the instrument by turning the [MASTER VOLUME] control.
- 4 To turn off the instrument, hold down the [⏻] (Standby/On) switch for about 1 second.]

⚠ WARNING

- Even when the instrument has been turned off, it still uses a small amount of power. If you plan not to use the instrument for a long period of time, be sure to unplug the AC adaptor from the AC outlet.

NOTICE

- When turning on the instrument by pressing the [⏻] (Standby/On) switch, do not perform any other operations such as pressing keys, buttons, or the foot switch. Otherwise, the instrument may malfunction.

NOTE

- (PSR-E583 only)
When batteries are the power source, the maximum volume is approximately at the 3 o'clock position of the [MASTER VOLUME] control. Turning it further clockwise will not change the volume.

Auto Power Off Function

In order to prevent unnecessary power consumption, this instrument features an Auto Power Off function, which automatically turns off the instrument if it has not been operated for a specified period of time. By default, the amount of time until the instrument is automatically turned off is set to 15 minutes; however, you can change the setting ([page 113, Function 079 \(PSR-E583\)/Function 078 \(PSR-E483\)](#)).

Simple Method of Deactivating the Auto Power Off Function

While holding down the lowest key on the keyboard, press the [⏻] (Standby/On) switch to turn on the instrument. “AutoPowerOff” appears in the upper display line, “Disabled” appears in the lower display line, and the instrument will not be automatically turned off.

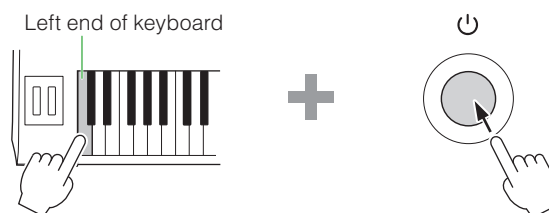

To activate the Auto Power Off function again, select the desired time in the Function setting display ([page 113, Function 079 \(PSR-E583\)/Function 078 \(PSR-E483\)](#)).

Using the Music Rest

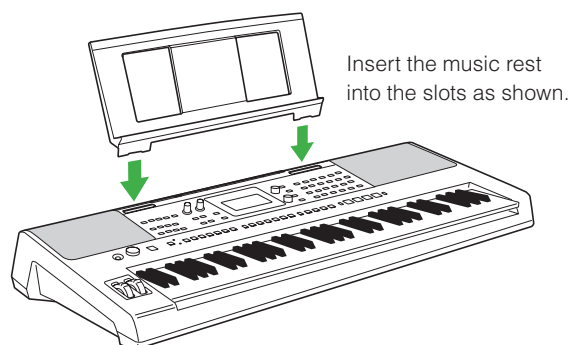

Panel Controls and Terminals

■ Top Panel

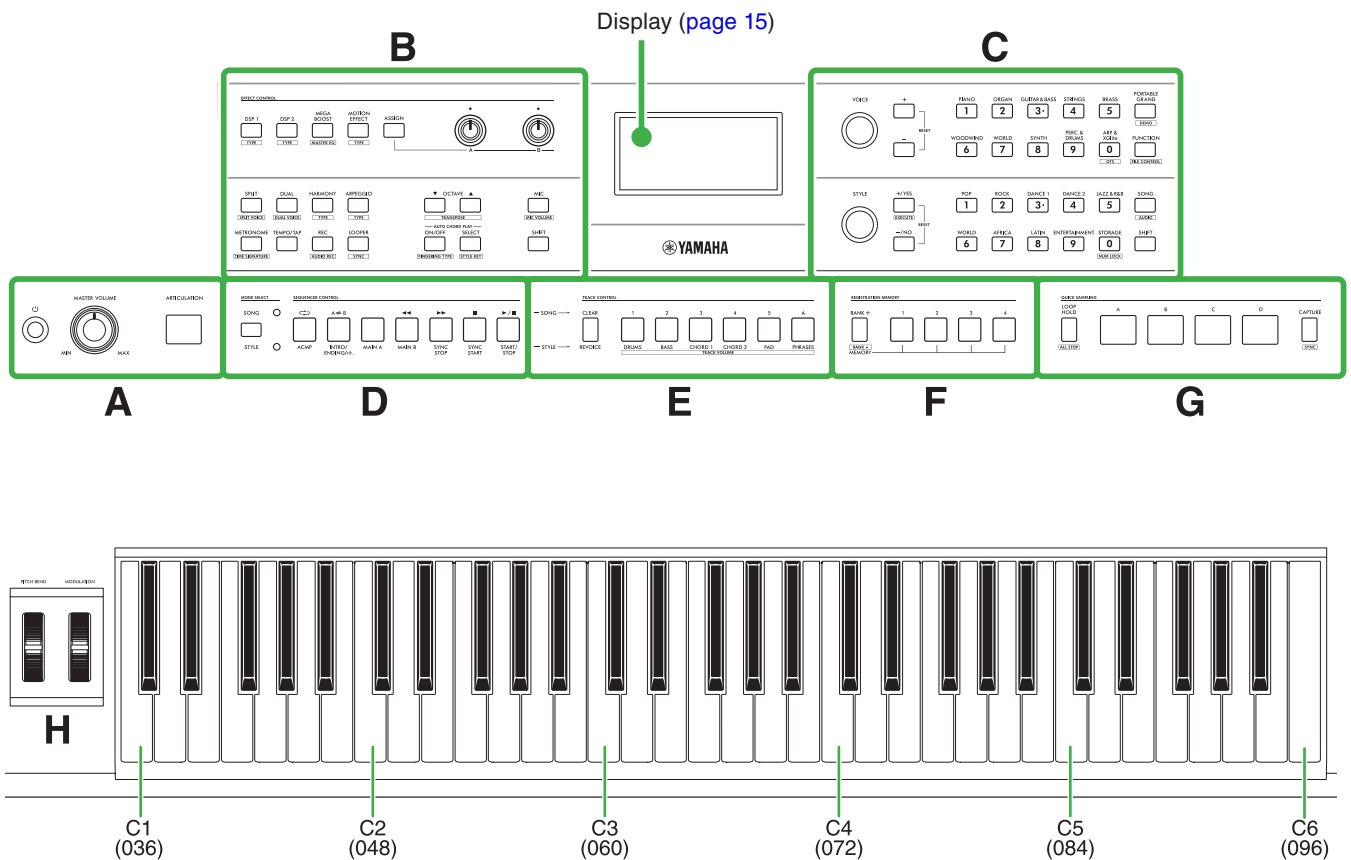

As shown, each key of the keyboard has been assigned a specific name (e.g., C1) and note number (e.g., 036), which are used when specifying various Function settings.

About Button Names in (SHIFT Function)

While holding down the **[SHIFT]** button, press a button with a box-surrounded name to call up the corresponding Function setting display. For example, while holding down the **[SHIFT]** button, press the **[MIC]** button to call up the **[MIC VOLUME]** setting display.

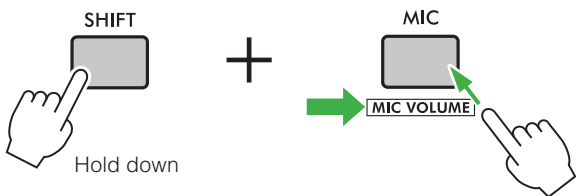

A

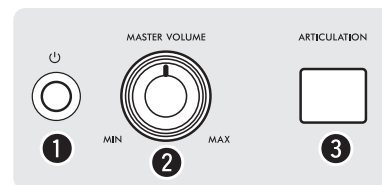

- ① [POWER] (Standby/On) switchpage 8
- ② [MASTER VOLUME] control.....page 8
- ③ [ARTICULATION] buttonpage 24

B

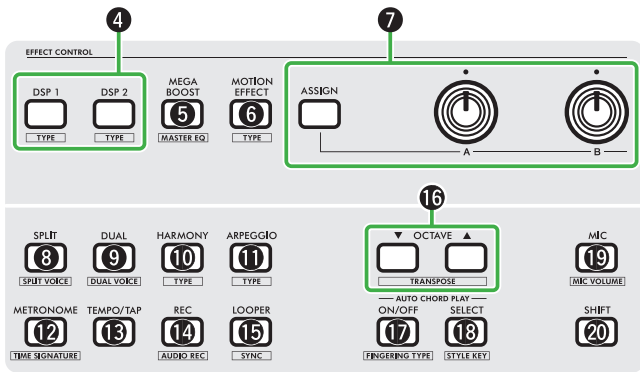

EFFECT CONTROL

- 4 [DSP1]/[DSP2] buttonspage 28
TYPE page 28
- 5 [MEGA BOOST] button.....page 18
MASTER EQ page 32
- 6 [MOTION EFFECT] button.....page 30
TYPE page 30
- 7 [ASSIGN] button, knobs [A]/[B].....page 47

OTHER CONTROLS (SUCH AS SOUND)

- 8 [SPLIT] buttonpage 22
SPLIT VOICE page 22, 106
- 9 [DUAL] button.....page 21
DUAL VOICEpage 21, 106
- 10 [HARMONY] buttonpage 25
TYPE page 25
- 11 [ARPEGGIO] buttonpage 26
TYPE page 26
- 12 [METRONOME] button page 16, 17
TIME SIGNATURE page 17
- 13 [TEMPO/TAP] buttonpage 16
- 14 [REC] button.....page 61
AUDIO REC page 68
- 15 [LOOPER] buttonpage 82
SYNC page 84
- 16 OCTAVE [▼]/[▲] buttonspage 19
TRANSPOSE page 19
- 17 AUTO CHORD PLAY [ON/OFF] button.....page 38
FINGERING TYPE page 36

- 18 AUTO CHORD PLAY [SELECT] buttonpage 38
STYLE KEY page 37
- 19 [MIC] button.....page 58
MIC VOLUME page 58
- 20 [SHIFT] button.....page 9, 14

C

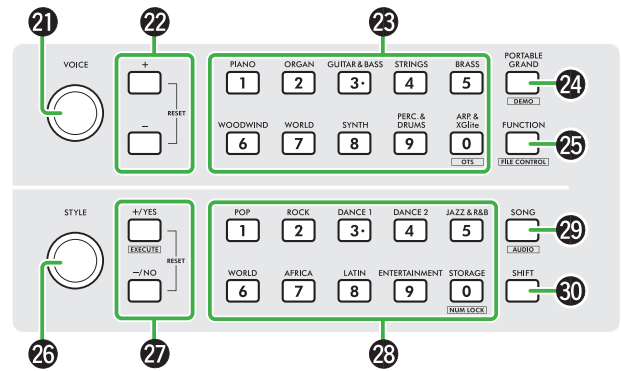

UPPER CONTROLS

- 21 [VOICE] dialpage 13
- 22 [+]/[-] buttonspage 13
- 23 VOICE category buttonspage 13
OTS page 20
- 24 [PORTABLE GRAND] buttonpage 20
DEMO page 53
- 25 [FUNCTION] buttonpage 104
FILE CONTROL page 90

LOWER CONTROLS

- 26 [STYLE] dialpage 13
- 27 [+]/YES/[−]/NO buttons.....page 13
EXECUTE page 91
- 28 STYLE category buttons.....page 13
NUM LOCK page 13
- 29 [SONG] button.....page 52
AUDIO page 54, 68
- 30 [SHIFT] button.....page 9, 14

D

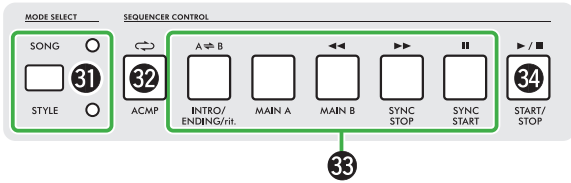

MODE SELECT

31 MODE SELECT button.....page 14

SEQUENCER CONTROL

32 []/[ACMP] buttonpage 34, 56

33 Playback control buttonspage 37, 41, 42, 53, 55

34 []/[START/STOP] buttonspage 34, 53

E

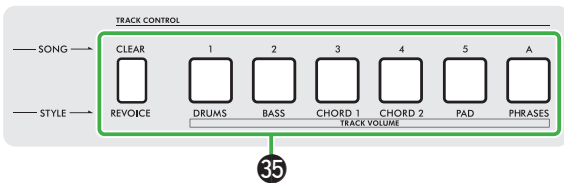

TRACK CONTROL

35 TRACK CONTROL buttonspage 42, 57
 TRACK VOLUMEpage 42, 57

F

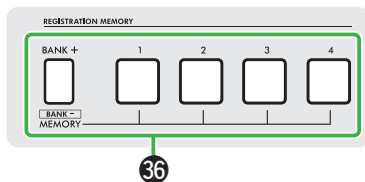

REGISTRATION MEMORY

36 REGISTRATION MEMORY buttonspage 70

G

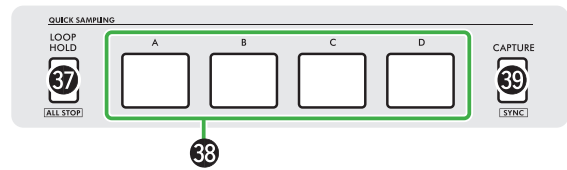

QUICK SAMPLING

37 [LOOP HOLD] buttonpage 73
 ALL STOPpage 73

38 Pads [A] to [D]page 73

39 [CAPTURE] buttonpage 75
 SYNCpage 74

H

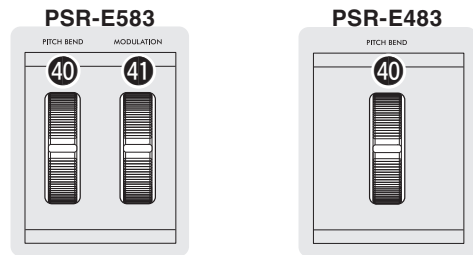

40 [PITCH BEND] wheelpage 32

41 [MODULATION] wheelpage 32

Panel Settings

The buttons and dials in the panel allow you to make various instrument settings, such as selecting Voices and Styles. These instrument settings are referred to as “panel settings” in this manual.

Rear Panel (View from back of instrument)

Connection Options

The specific cables necessary depend on the device being connected.

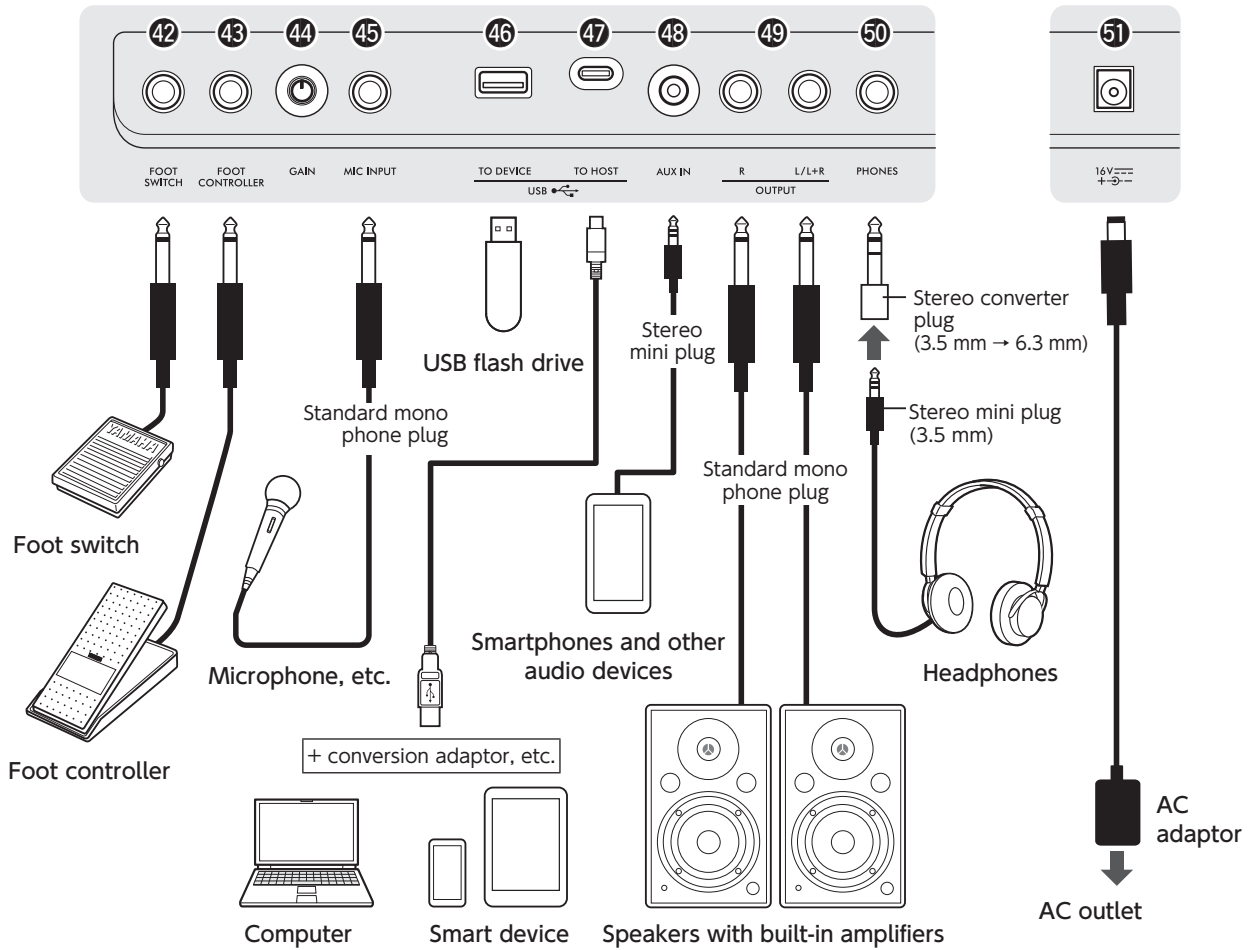

- 42 [FOOT SWITCH] jackpage 97
- 43 [FOOT CONTROLLER] jackpage 97
- 44 [GAIN] knobpage 58
- 45 [MIC INPUT] jack.....page 58
- 46 [USB TO DEVICE] terminal (USB Type-A)....page 89

- 47 [USB TO HOST] terminal (USB Type-CTM) ...page 99
- 48 [AUX IN] jack.....page 98
- 49 OUTPUT [L/L+R], [R] jackspage 98
- 50 [PHONES] jackpage 97
- 51 DC IN jackpage 6

Basic Operations and Display Information

Basic Operations

The Style and Voice, Tempo settings, Function settings, etc., can all be specified in similar ways. For lists of Voice and Style numbers and names, refer to the Data List on the website.

Selecting Items/Specifying Values

The parameter in the upper display line (page 15, 14) is set with the upper controls. The parameter in the lower display line is set with the lower controls.

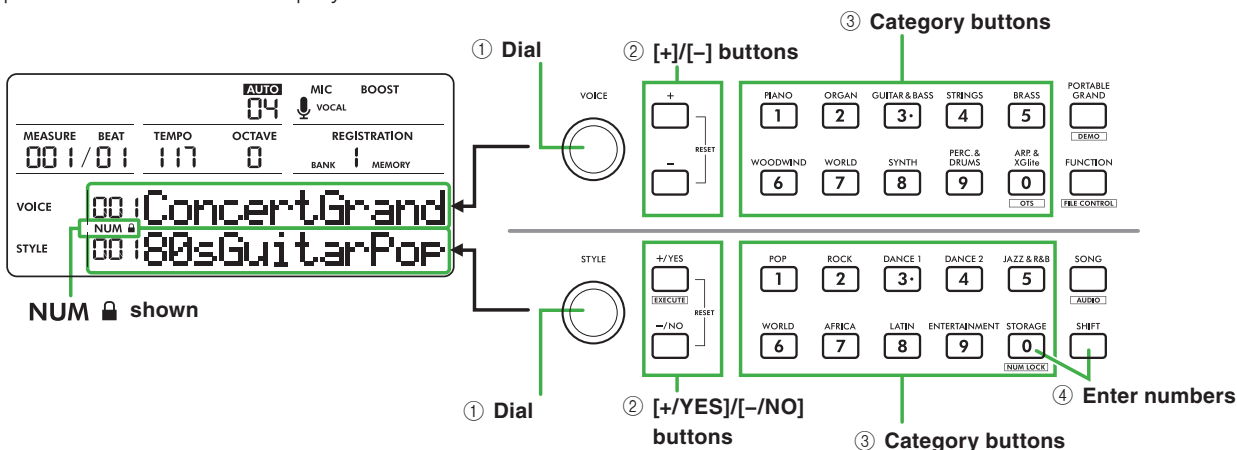

Items can be selected or values specified using any of the following four methods.

① Selecting with a dial

The setting that is shown in the upper display line is selected with the [VOICE] dial, and the setting that is shown in the lower display line is selected with the [STYLE] dial.

Rotate the dial clockwise to increase the value, or counterclockwise to decrease the value.



NOTE

- In most procedures described throughout this document, the dials are used for selecting items or changing values.

② Selecting with the [+]/[-] buttons or [+]/YES or [-]/NO buttons

The setting that is shown in the upper display line is selected with the [+]/[-] buttons, and the setting that is shown in the lower display line is selected with the [+]/YES or [-]/NO buttons.

Hold down the [+]/[-] button or [+]/YES or [-]/NO button to continuously increase/decrease the value. In addition, the [+]/[-] buttons or [+]/YES or [-]/NO buttons can be used to restore the default setting. (Refer to the right.)

③ Selecting with the category buttons (Voice and Style only)

Each press of the category button switches to the next item within the category.

④ Selecting by entering numbers

If the [STORAGE] button is pressed while the [SHIFT] button is being held down, NUM LOCK is shown in the display, and the category buttons [1] to [0] can be used to enter numbers.

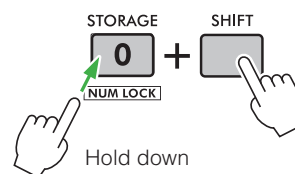

NOTE

- With settings other than for Voice or Style, the category buttons can be used to enter numbers.

Reverting a Parameter to its Default Setting

To revert to the default setting, simultaneously press the [+]/[-] buttons or the [+]/YES or [-]/NO buttons. The Voice or Style, for example, reverts to the 001 setting.

Video Manuals About Basic Operations

These show how to perform basic operations.

https://manual.yamaha.com/mi/rt/psr-e483/videos/w/basic_operations/

Display Information

Home Display

The display that shows the Voice name in the upper line and the Song or Style name in the lower line, as shown below, is called the “Home display.”

After the instrument has been turned on, the Voice name (VOICE) is shown in the upper display line, and the Style name (STYLE) is shown in the lower display line.

Each press of the **MODE SELECT** button alternately calls up the Song name or Style name in the lower display line.

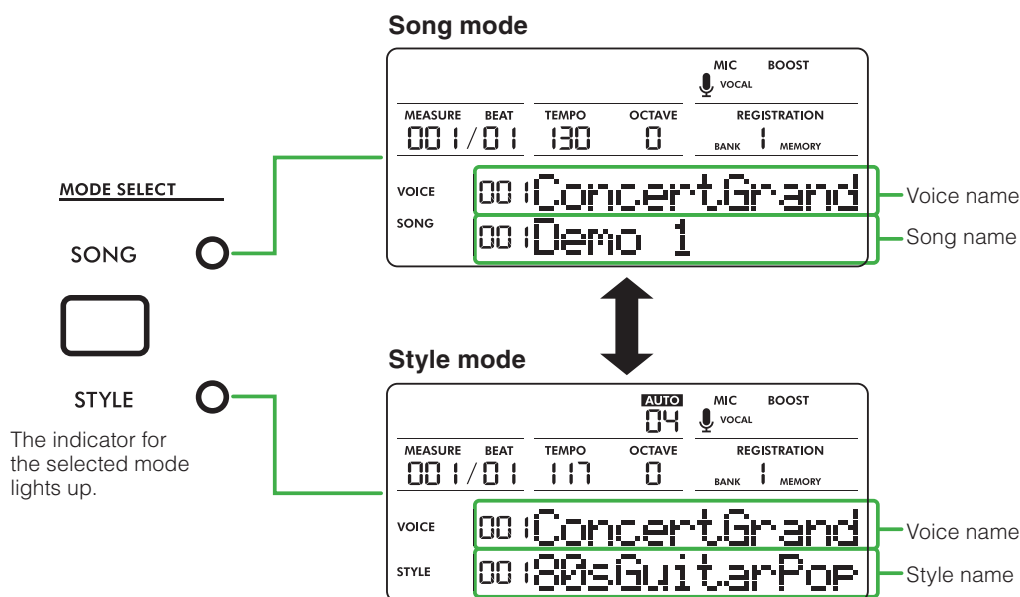

Returning to the Home Display

To return to the home display from the Function setting display (page 104) or Tempo display, press the **[SHIFT]** button.

Example: Tempo display

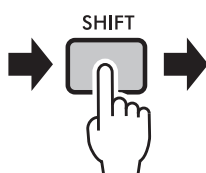
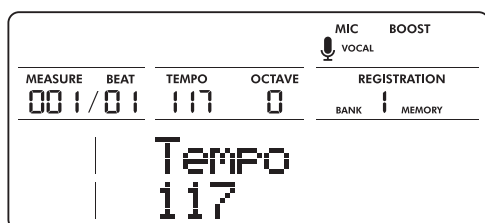

Home display

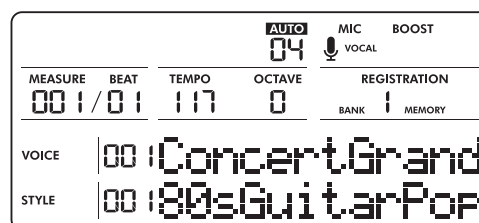

Display Information

The display shows the current instrument settings, such as Voice, Style, Song and audio file.

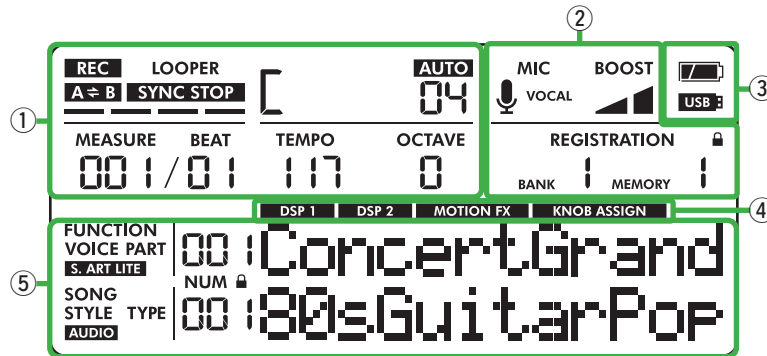

① Playback/Recording status and function status

Indicates the playback or recording status as well as other information such as the detected chord and tempo.

REC	While recording or in recording standby (page 60)
A ⇄ B	A-B Repeat (page 55) is on
LOOPER	Looper function (page 82) is in use
SYNC STOP	Sync Stop (page 42) is on
MEASURE BEAT 001 / 01	MEASURE : Current measure number during playback BEAT : Current beat during playback
C	Chord played in Auto Accompaniment area (page 33), chord of Auto Chord Play (page 38), or chord specified by Song playback (page 52)
AUTO 04	AUTO : Auto Chord Play is on Numbers : Displays a continuous countdown of the number of measures (chords) to be played
TEMPO 117	Tempo (page 16)
OCTAVE 0	Setting specified with the OCTAVE [▼]/[▲] buttons

② Function status (1)

Indicates the on/off status of each function.

MIC VOCAL	Microphone (page 58)
BOOST	Mega Boost (page 18)
REGISTRATION BANK 1 MEMORY 1	Registration Memory status (page 70) <ul style="list-style-type: none"> • Bank number • Memory number where settings were last saved to/recalled from • Freeze on/off

③ Battery/USB status

Indicates the battery status and the USB flash drive status.

	Battery status (page 7)
USB	USB flash drive connection status (page 90)

④ Function status (2)

Indicates that the setting display for each function is shown.

DSP 1 DSP 2	DSP (page 28)
MOTION FX	Motion Effect (page 30)
KNOB ASSIGN	Functions assigned to knobs [A]/[B] (page 47)

⑤ Main display

Indicates the currently selected Voice name and Style name and number. Indicates the function number and name while in the Function setting display (page 104). The indicators to the left of the Voice name indicate the following.

FUNCTION	Function setting display is called up (page 104)
VOICE	Voice name is shown (page 20)
PART	Target for DSP effect is shown (page 28)
S. ART LITE	S. Art Lite Voice is selected (page 24)
SONG	Song mode is selected (page 14)
STYLE	Style mode is selected (page 14)
TYPE	DSP1/2 effect type is shown (page 28)
AUDIO	Playing back or recording an audio file (page 54, 68)
NUM	Numbers can be entered (page 13)

Using the Common Functions

Changing the Tempo

The tempo of the metronome, Style ([page 33](#)) and Song ([page 52](#)) can be changed.

- 1 Press the [TEMPO/TAP] button to call up the Tempo setting display.

The current tempo value is shown.

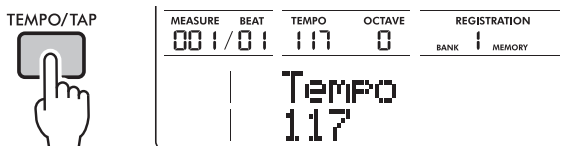

- 2 Rotate the [STYLE] dial to change the tempo.

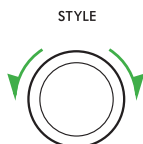

- 3 Press the [SHIFT] button to exit the Tempo setting display.



Using the Tap Function

During playback of a Style or Song, you can change the tempo by tapping the [TEMPO/TAP] button twice at the desired tempo. When the Style or Song is stopped, tapping the [TEMPO/TAP] button (four times for a 4/4 time signature) starts playback at the tempo that was tapped.



Using the Metronome

Use the metronome to practice at a precise tempo.

- 1 Press the [METRONOME] button to start the metronome.

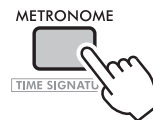

- 2 Press the [METRONOME] button again to stop the metronome.

Adjusting the Metronome Volume

Specify the setting in the Function setting display ([page 111](#), [Function 062](#) (PSR-E583)/[Function 061](#) (PSR-E483)).

Default setting: 100

Setting range: 0 to 127

Setting the Time Signature of the Metronome

Although each selected Style or Song has its optimized default setting, you can change it as desired. Here, let's try changing the time signature to 6/8.

- 1 While holding down the [SHIFT] button, press the [METRONOME] button.

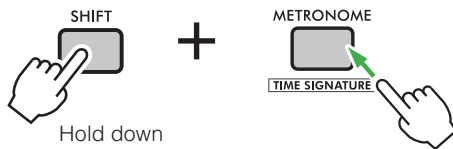

The metronome time signature (numerator) setting display "Time Sig Top" (page 111, Function 060 (PSR-E583)/Function 059 (PSR-E483)) is called up.

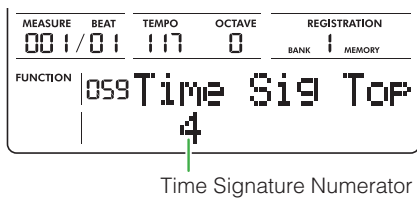

- 2 Rotate the [STYLE] dial to select the number of beats per measure.

A chime sounds on the first beat of each measure, and a click sounds on the other beats. When "0" is selected, a click sounds on all beats. Here, select "6."

Setting range: 0 to 60

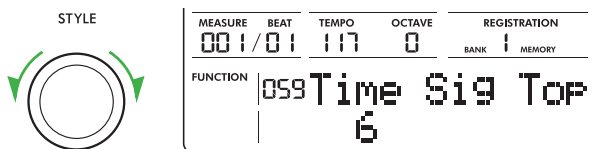

NOTE

- This parameter cannot be set during playback of a Style or Song.

- 3 Rotate the [VOICE] dial until "Time Sig Btm" (Function 061 (PSR-E583)/Function 060 (PSR-E483)) is shown in the upper display line.

The metronome time signature (denominator) setting display is called up.

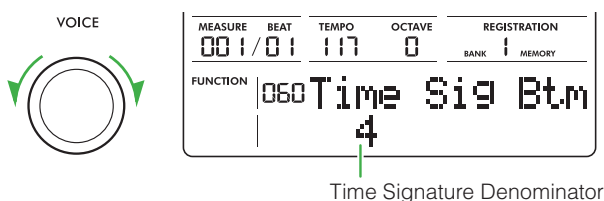

- 4 Rotate the [STYLE] dial to select from 2 (half note), 4 (quarter note), 8 (eighth note) or 16 (sixteenth note) as the duration of a beat. Here, select "8" (eighth note).

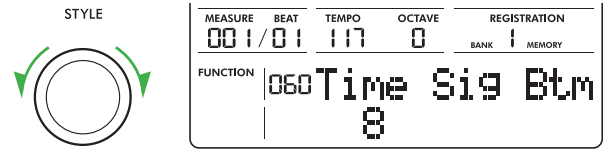

- 5 Press the [SHIFT] button to exit the setting display.

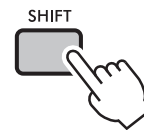

- 6 Play the metronome to hear the result.

Each beat is the length of an eighth note, and a click sounds on every sixth beat.

Boosting the Overall Volume of the Instrument (Mega Boost)

The Mega Boost function increases the volume of the instrument by up to about 6 dB, allowing you to enjoy a more powerful performance without having to connect external speakers. Each press of the **[MEGA BOOST]** button changes the level in the following order.



BOOST 	Increase in volume (by approx. +3 dB)
BOOST 	Maximum increase in volume (by approx. +6 dB)
(No indication)	Mega Boost off

NOTICE

- Using a microphone while the Mega Boost function is on may cause acoustic feedback. If this happens, try resolving the problem in the following ways.
 - Turn down the microphone volume.
 - Turn down the Mega Boost level.
 - Turn off the Mega Boost function.
- While the Mega Boost function is on, the sound may be distorted depending on the selected Voice or Style.

NOTE

- When headphones are connected, the Mega Boost function is turned off automatically.
- The Mega Boost function is effective on not only the built-in speaker but also the output from the **OUTPUT [L/L+R]** and **[R]** jacks.

Changing the Touch Sensitivity of the Keyboard (Touch Response)

The Touch Response function allows you to specify how hard a key must be pressed to obtain a certain sound volume (touch sensitivity). The key weight does not actually change.

- Press the **[FUNCTION]** button to call up the Function setting display.



- Rotate the **[VOICE]** dial until “TouchRespons” (**Function 006**) is shown in the upper display line. The current touch sensitivity setting is shown in the lower display line.

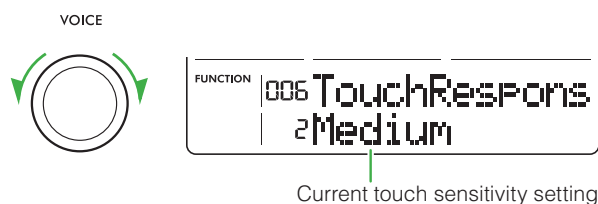

- Rotate the **[STYLE]** dial to select the desired touch sensitivity.

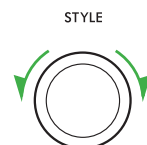

Touch Response

1	Soft	Results in relatively loud sounds, even when playing softly.
2	Medium	Results in normal response, where soft playing produces soft sounds and strong playing produces loud sounds. (Default setting)
3	Hard	Requires more forceful playing to produce loud sounds.
4	Off	Results in a fixed volume, no matter what your playing strength.

- Press the **[SHIFT]** button to exit the Function setting display.



Changing the Pitch of the Instrument (Transpose)

The overall pitch of the instrument (except for the Drum/SFX Kit Voices (Voice No. 353–392 (PSR-E583)/323–362 (PSR-E483))) can be shifted up or down in semitone increments, within a range of ± 1 octave.

- 1 Press the [FUNCTION] button to call up the Function setting display.

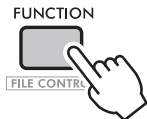

- 2 Rotate the [VOICE] dial until “Transpose” (Function 002) is shown in the upper display line.

The current Transpose value is shown in the lower display line.

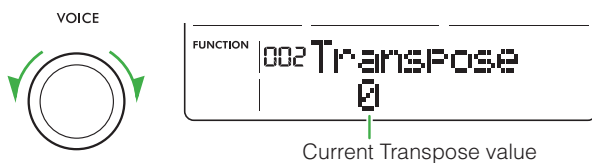

- 3 Rotate the [STYLE] dial to change the Transpose value.

Setting range: -12 to 12
Default setting: 0

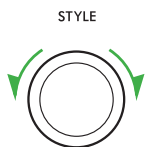

NOTE

- You can also change the Transpose value by pressing the **OCTAVE** [▼] or [▲] button while holding down the [SHIFT] button.

- 4 Press the [SHIFT] button to exit the Function setting display.



Raising/Lowering Instrument Pitch by One Octave

To raise or lower the overall pitch of the instrument in one-octave increments, press the **OCTAVE** [▼]/[▲] button.

Setting range: -2 to 0 to 2
Default setting: 0

Finely Adjusting the Pitch of the Instrument (Tuning)

The overall pitch of the instrument can be finely adjusted between 427.0 Hz and 453.0 Hz in increments of approximately 0.2 Hz. By making fine adjustments, you can change the overall tuning of the instrument, except for the Drum/SFX Kit Voices (Voice No. 353–392 (PSR-E583)/323–362 (PSR-E483)).

- 1 Press the [FUNCTION] button to call up the Function setting display.



- 2 Rotate the [VOICE] dial until “Tuning” (Function 003) is shown in the upper display line.

The current Tuning value is shown in the lower display line.

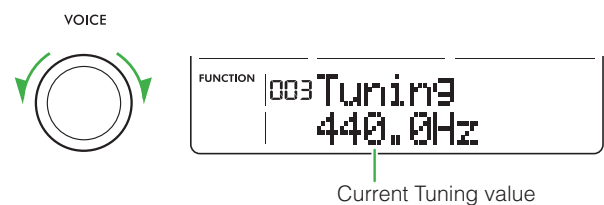

- 3 Rotate the [STYLE] dial to select the desired value.

Setting range: 427.0 Hz to 453.0 Hz
Default setting: 440.0 Hz

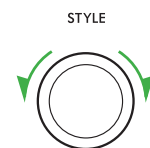

- 4 Press the [SHIFT] button to exit the Function setting display.



Playing a Variety of Voices (Instrument Sounds)

You can choose from a variety of Voices other than Piano. Not only can you play just a single Voice (Main Voice), but you can also layer on a different Voice (Dual Voice), or divide the keyboard in half and play different Voices with your left and right hands (Split Voice).

Selecting a Main Voice

- 1 Rotate the [VOICE] dial to select the desired Voice (page 13).

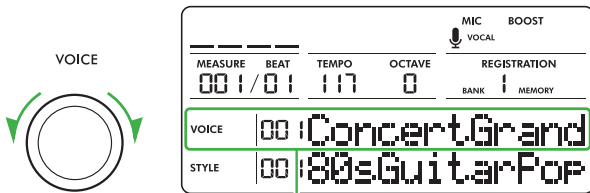

The name and number of the selected Voice is shown here.

NOTE

- For details on making a selection in other ways than with the dial, refer to page 13.

Voice Types

PSR-E583	PSR-E483	
001 : 352	001 : 322	Instrument sounds. With some voices, using the [ARTICULATION] button allows you to reproduce the performance techniques specific to certain instruments, such as guitar harmonics (page 24, S. Art Lite Voices).
353 : 392	323 : 362	Various drum/percussion or SFX sounds assigned to individual keys. For details on assigning instruments to keys, refer to "Drum Kit List" in the Data List on the website.
393 : 432	363 : 402	Used for arpeggio performances (page 26). When one of these is selected, the Arpeggio function is automatically turned on.
433 : 890	403 : 860	XGlite Voices, which are simplified (light) versions of Yamaha's high-quality sound source format, "XG." For details, refer to "Voice List" in the Data List on the website.
000	000	One-Touch Setting (OTS) (Refer to the right.)

For a list of Voice numbers and names, refer to the Data List on the website.

- 2 Play the keyboard.

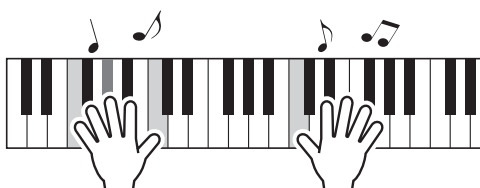

Playing with the Sound of a Grand Piano

To reset the various settings and play with the sound of a piano, press the [PORTABLE GRAND] button.



All keys will play the "Live! Concert Grand Piano" (Voice No. 001) sound.

Calling Up Optimum Panel Settings —One-Touch Setting (OTS)

The optimum panel settings (Voice, tempo, etc.) for the currently selected Song or Style can be called up.

- 1 If necessary, press the MODE SELECT button to select the Style or Song mode.

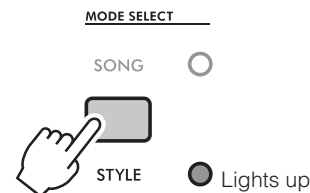

- 2 Select the desired Style or Song (page 13).

- 3 Rotate the [VOICE] dial to select Voice No. 000 ("OTS").

You can also select "OTS" by holding down the [SHIFT] button and pressing the [ARP. & Xglite] button.

Adding a Layer - Dual Voice

In addition to the Main Voice, you can layer a second, different Voice over the entire keyboard as a “Dual Voice.”

- 1 Press the [DUAL] button to turn on the Dual function.



Lights up when Dual function is on

- 2 Play the keyboard.

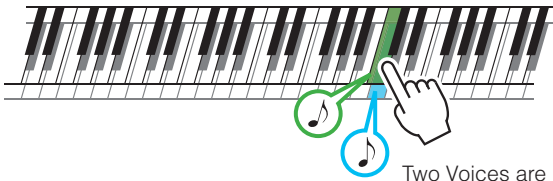

Two Voices are played at the same time.

- 3 To turn off the Dual function, press the [DUAL] button again.

Changing the Dual Voice

Although turning on the Dual Voice function automatically calls up the optimum Dual Voice for the current Main Voice, you can select a different Dual Voice as desired. While in the display that is called up by holding down the [SHIFT] button and pressing the [DUAL] button, rotate the [VOICE] dial to select the desired Voice. For details on the Voices, refer to [page 20](#).

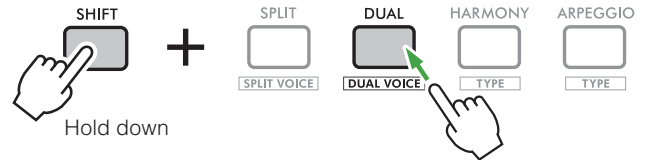

Hold down

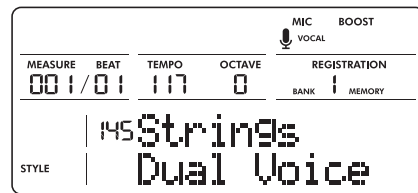

To return to the home display ([page 14](#)) from the display where the Dual Voice can be changed, press the [SHIFT] button.

Adjusting the Volume of the Dual Voice

Specify the setting in the Function setting display ([page 106](#), [Function 016](#)).

Playing Different Voices with the Left and Right Hands (Split Voice)

The entire keyboard can be divided into two areas so that different Voices can be played with your right and left hands.

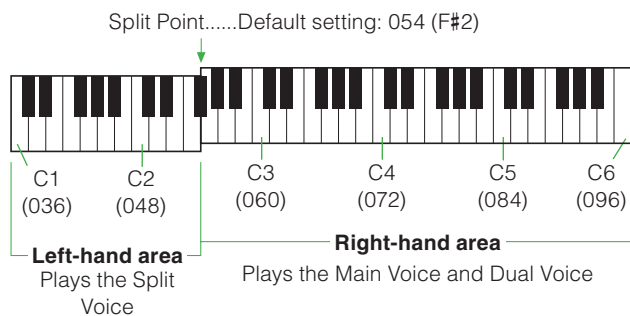

The “Split Voice” is produced in the left-hand area of the keyboard, and the “Main Voice” and “Dual Voice” are produced in the right-hand area. The division between the left-hand area and right-hand area is called the “Split Point,” which can be changed as desired. The key at the Split Point belongs to the left-hand area.

- 1 Press the [SPLIT] button to turn on the Split function.



Lights up when Split function is on

The keyboard is divided into left- and right-hand areas.

- 2 Play the keyboard.

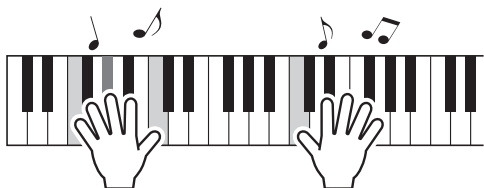

- 3 To turn off the Split function, press the [SPLIT] button again.

Changing the Split Voice

While in the display that is called up by holding down the [SHIFT] button and pressing the [SPLIT] button, rotate the [VOICE] dial to select the desired Split Voice. For details on the Voices, refer to [page 20](#).

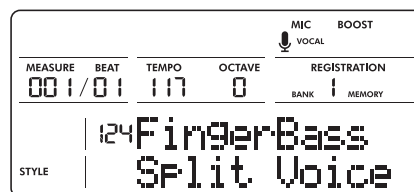
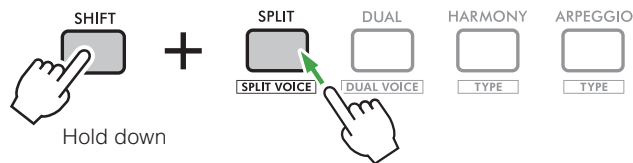

To return to the home display ([page 14](#)) from the display where the Split Voice can be changed, press the [SHIFT] button.

Changing the Split Point

While holding down the [SPLIT] button, press the desired key for the Split Point.

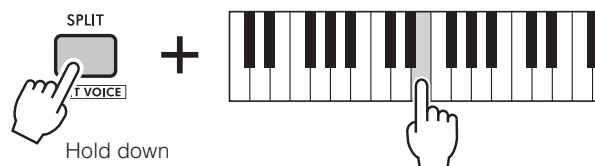

You can also change the Split Point in the Function setting display ([page 105](#), [Function 005](#)).

Adjusting the Volume of the Split Voice

Specify the setting in the Function setting display ([page 106](#), [Function 025](#)).

Changing Voice Settings

Each of the Main, Dual and Split Voices can be edited with the available parameters, including volume, octave and Reverb/Chorus depth —allowing you to create new, custom sounds to best suit your own musical preferences.

- 1 Press the [FUNCTION] button to call up the Function setting display.

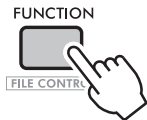

- 2 Rotate the [VOICE] dial until the desired parameter is shown.

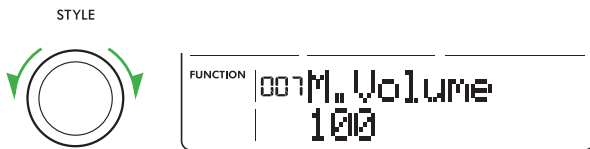

Voice parameters are indicated as shown below.

- **Main Voice parameters:**
M.***** (Function 007 to 015)
- **Dual Voice parameters:**
D.***** (Function 016 to 024)
- **Split Voice parameters:**
S.***** (Function 025 to 029)

For details on each parameter, refer to page 105 to 106 of “Function List.”

- 3 Rotate the [STYLE] dial to change the value.

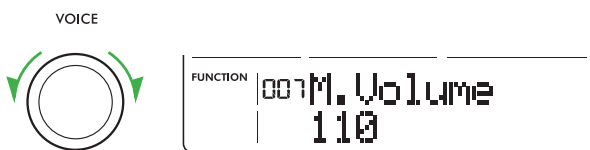

- 4 Repeat steps 2 to 3 above to continue editing each parameter as desired.

- 5 Press the [SHIFT] button to exit the Function setting display.

- 6 If desired, save your new settings to a Registration Memory (page 70).

Saving your settings allows you recall the custom Voice sound when you wish to use it again.

NOTICE

- Be sure to save your Voice settings before selecting a different Voice. All settings related the Voice are reset when a different Voice is selected.

Adding Articulation Effects

Articulation reproduces the performance techniques specific to certain instruments, such as guitar harmonics. Articulation is added to your performance only while the **[ARTICULATION]** button is held down. Voices to which Articulation can be added are called “S. Art Lite (Super Articulation Lite) Voices.”

1 Select the desired S. Art Lite Voice.

When an S. Art Lite Voice has been selected, **S. ART LITE** is shown in the display. In addition, S. Art Lite Voices are marked with “****” in “Voice List” of the Data List on the website.

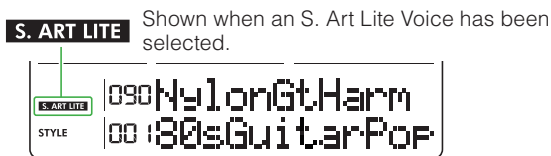

2 Hold down the **[ARTICULATION]** button while playing the keyboard.

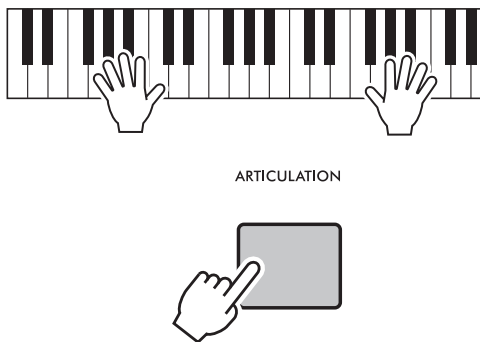

To turn off the Articulation function, release the **[ARTICULATION]** button.

NOTE

- **(PSR-E583 only)**
With S. Art Lite Voice No. 061, 180, and 300, while playing the keyboard, you can move the **[MODULATION]** wheel to change the sound, such as to a different waveform (page 32).

Using a Pedal to Add Articulation

If the Articulation function has been assigned to a pedal (foot switch) in the Function setting display (page 109, Function 054), you can conveniently step on the pedal to apply the effect while playing.

NOTE

- The Articulation effect is only applied to the Main Voice.
- S. Art Lite Voices sound differently depending on how hard a key is pressed (velocity).

Examples of Articulation Effects

If you select a guitar Voice, you can use the following operations to realistically reproduce playing techniques that are unique to the guitar.

Example 1: Voice No. 090 (PSR-E583)/081(PSR-E483) “S. Art Lite Nylon Guitar Harmonics”

Hold down the **[ARTICULATION]** button while playing the keyboard to recreate guitar harmonics.

Example 2: Voice No. 094 (PSR-E583)/085(PSR-E483) “S. Art Lite Distortion Guitar”

Press the **[ARTICULATION]** button to make scratch noises.

The optimum Articulation effect for a Voice is applied only if the S. Art Lite Voice is selected. Otherwise, the Articulation effect is not added. Instead, a modulation effect is applied to the produced sound.

Using the Harmony Function

You can apply a Harmony effect, such as Duet and Trio as well as Tremolo and Echo, to the Main Voice played on the keyboard.

1 Press the [HARMONY] button.

The [HARMONY] button lights up, and the Harmony function is turned on.



Lights up when Harmony function is on

2 Play the keyboard.

The optimum Harmony type for the selected Voice is applied.

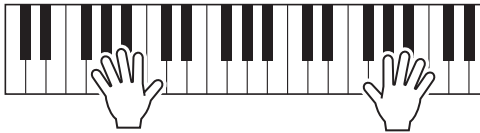

The playing style differs depending on the Harmony type. For details, refer to “Playing the Harmony Types” below.

3 To turn off the Harmony function, press the [HARMONY] button again.

Changing the Harmony Type

Although selecting a Voice automatically calls up the optimum Harmony type for that Voice, you can select a different type as desired.

1 While holding down the [SHIFT] button, press the [HARMONY] button.

“Harmony” is shown in the upper display line, and the current type is shown in the lower display line.

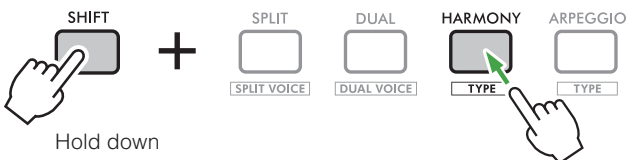

Currently selected type

2 Rotate the [STYLE] dial to select the type.

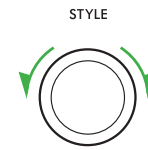

For details on the Harmony types, refer to the Data List on the website.

Playing the Harmony Type

● Harmony types 001 to 005

Split Point.....Default setting: 054 (F#2)



Turn ACMP on ([page 33](#)), and then play the melody with the keys in the right-hand area while playing chords in the Auto Accompaniment area of the keyboard.

NOTE

- You can play with Harmony effects applied, even without using Style accompaniments or rhythm patterns ([page 35](#)).

● Harmony types 006 to 012 (Trill)

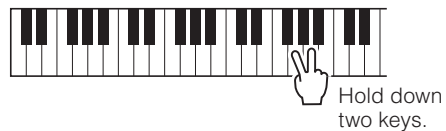

Hold down two keys.

● Harmony types 013 to 019 (Tremolo)

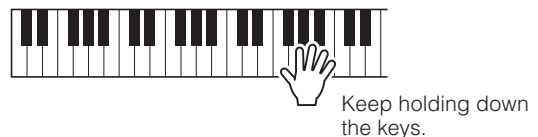

Keep holding down the keys.

● Harmony types 020 to 026 (Echo)

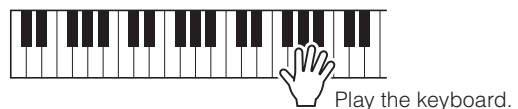

Play the keyboard.

Adjusting the Harmony Volume

Adjust the Harmony volume in the Function setting display ([page 109](#), [Function 050](#)).

Using the Arpeggio Function

You can automatically play an arpeggio with the press of a key.

1 Press the [ARPEGGIO] button.

The [ARPEGGIO] button lights up, and the Arpeggio function is turned on.

With Voice No. 393–432 (PSR-E583)/363–402 (PSR-E483), simply selecting a Voice automatically turns on the Arpeggio function (the button lights up). With any other Voice, press the [ARPEGGIO] button to turn on the Arpeggio function. When the function is on, the optimum Arpeggio type for the selected Voice is applied.



Lights up when Arpeggio function is on

2 Rotate the [STYLE] dial to select the type.

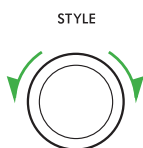

For details on the Arpeggio types, refer to the Data List on the website.

NOTE

- Arpeggio types 117 to 164 can only be applied to a Main Voice. For details, refer to the Data List on the website.

3 Play the keyboard.

Different Arpeggio phrases are played depending on the number of keys pressed and their positions on the keyboard.

Depending on whether the Split function (page 22) is on or off, the Voice that Arpeggio is applied to differs as follows.

When Split function is off:

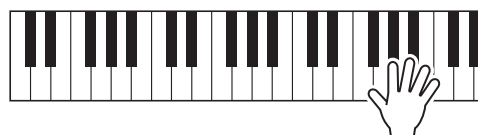

Arpeggio is automatically applied to the Main Voice/Dual Voice.

When Split function is on:

Split Point.....Default setting: 054 (F#2)



Arpeggio is automatically applied to only the Split Voice.

4 To turn off the Arpeggio function, press the [ARPEGGIO] button again.

NOTE

- With Voice No. 423–432 (PSR-E583)/393–402 (PSR-E483), simply selecting a Voice automatically turns on the Split function in addition to the Arpeggio function. When one of these Voices is selected, Arpeggio is applied only to the Split Voice and is triggered only by playing keys to the left of the Split Point (page 22).
- By assigning the Arpeggio Hold function to the foot switch, Arpeggio will continue to play after the keys are released. For details, refer to page 27.

Specifying the Arpeggio Velocity (Force)

Adjust the Arpeggio velocity in the Function setting display (page 109, Function 052).

Synchronizing an Arpeggio to Style/Song Playback (Arpeggio Quantize)

When playing the keyboard to trigger an Arpeggio along with Style/Song playback, notes must be played with accurate timing in order to keep the Arpeggio synchronized with the playback track. However, since your actual timing may be slightly ahead of or behind the beat (or both), you can use the following three settings of the Arpeggio Quantize function to correct any slight imperfections in the timing in order to ensure appropriate Arpeggio playback.

- Off: No synchronization
- 1/4: Synchronizes to quarter notes
- 1/8: Synchronizes to eighth notes
- 1/16: Synchronizes to sixteenth notes

This parameter is called “Arpeggio Quantize.” Although selecting an Arpeggio type automatically calls up the optimum Arpeggio Quantize setting, you can select a different setting as desired.

- 1 Press the [FUNCTION] button to call up the Function setting display.

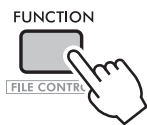

- 2 Rotate the [VOICE] dial until “Arp Quantize” (Function 053) is shown in the upper display line. The current setting is shown in the lower display line.

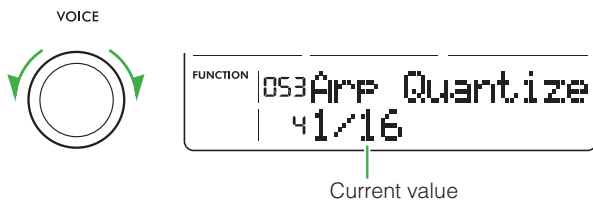

- 3 Rotate the [STYLE] dial to select from 1/4, 1/8 or 1/16.

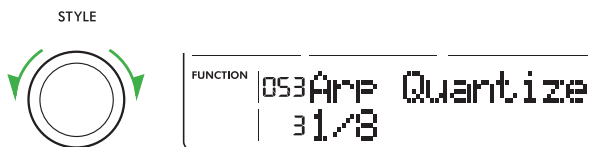

- 4 Press the [SHIFT] button to exit the Function setting display.

Maintaining Arpeggio Playback via the Foot Switch (Arpeggio Hold)

You can set the instrument so that Arpeggio playback continues, even after the keys have been released, as long as you keep pressing the foot switch connected to the [FOOT SWITCH] jack.

- 1 Press the [FUNCTION] button to call up the Function setting display.



- 2 Rotate the [VOICE] dial until “Foot Switch” (Function 054) is shown in the upper display line. The function currently assigned to the foot switch is shown in the lower display line.

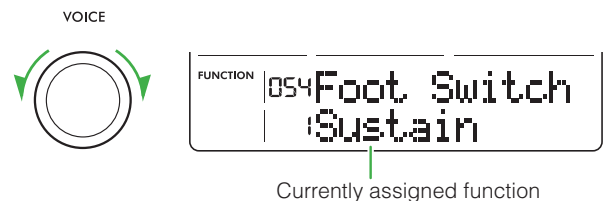

- 3 Rotate the [STYLE] dial to select “ArpeggioHold.”



To revert the foot switch to a sustain pedal, select “Sustain.” To use both the Arpeggio Hold and Sustain functions, select “Sus+ArpHold.”

- 4 Press the [SHIFT] button to exit the Function setting display.

- 5 Try playing the Arpeggio with the foot switch. Play the keyboard to trigger the Arpeggio, and then press the foot switch. Arpeggio playback continues even after you release the keys. To stop Arpeggio playback, release the foot switch.

Adding Effects to Performance and Playback

Adding DSP Effects

This instrument is equipped with two DSPs (digital signal processors) for applying digital effects that enhance the sound (DSP 1 and DSP 2). DSP 1 applies DSP effects to the Main Voice, and DSP 2 applies DSP effects to specified parts.

Changing the DSP 1 Type

Although selecting a Main Voice automatically calls up the optimum DSP 1 effect for that Voice, you can select a different effect type by performing the following operation.

- 1 While holding down the [SHIFT] button, press the [DSP 1] button to call up the DSP 1 type setting display.

The current DSP 1 type is shown in the lower display line.

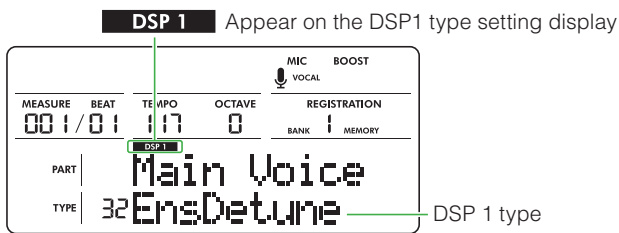
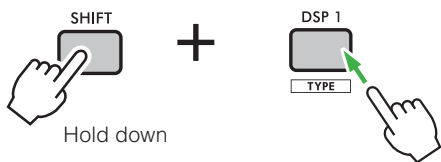

- 2 Rotate the [STYLE] dial to select the desired DSP 1 type.

For details on the DSP 1 types, refer to “Effect Type List” in the Data List on the website.

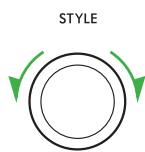

- 3 Press the [SHIFT] button to exit the DSP 1 type setting display.



- 4 Play the keyboard to hear the DSP 1 effect selected in step 2.

- 5 Press the [DSP 1] button again to turn off DSP 1.

Specifying DSP 2 Settings

The DSP 2 effect is not automatically specified. You can turn on/off the DSP 2 effect and select its type and target.

- 1 Press the [DSP 2] button to turn on DSP 2.

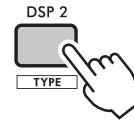

- 2 While holding down the [SHIFT] button, press the [DSP 2] button to call up the DSP 2 setting display.

The current target part for the effect is shown in the upper display line, and the current DSP 2 type is shown in the lower display line.

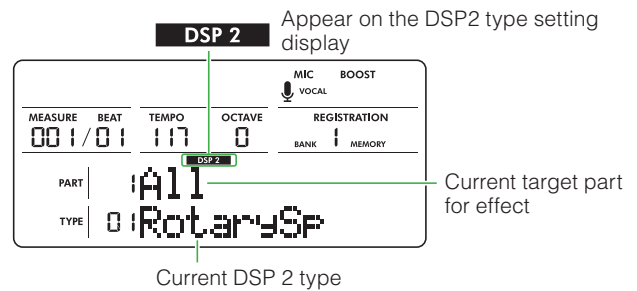
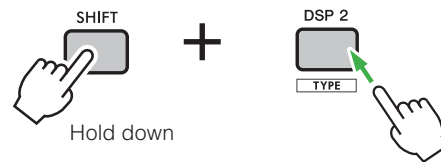

- 3 Rotate the [VOICE] dial to select the target part for the effect.

From the target parts listed below, select one for the effect.



	Display	Target Part for Effect
1	All	All parts from 2 to 5
2	Keyboard	Main, Dual, and Split Voices
3	Backing	Style, Looper, Song playback, MIDI input
4	Mic	Microphone input
5	Sampling	Sampling pad playback

NEXT PAGE

4 Rotate the [STYLE] dial to select the desired DSP 2 type.

For details on the DSP 2 types, refer to “Effect Type List” in the Data List on the website.

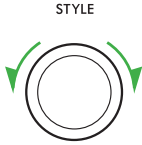

5 Press the [SHIFT] button to exit the DSP 2 type setting display.

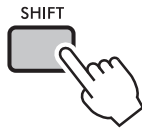

6 Play the part selected in step 3 to make sure that the DSP 2 effect is applied.

7 Press the [DSP 2] button again to turn off DSP 2.

NOTE

- DSP 1 and DSP 2 settings (type, on/off, and target part) are not recorded in User Songs (MIDI). However, you can record your performance with DSP effects and save it as an audio file to a USB flash drive.
- DSP 1 and DSP 2 settings can be saved to and recalled from Registration Memory (page 70).
- For a block diagram of DSP 1, DSP 2, and other effects, refer to page 115.

Video Manuals About DSP

These show how to use DSP.

<https://manual.yamaha.com/mi/rt/psr-e483/videos/w/dsp/>

Adding Motion Effects

You can add dynamic effects to your performance. Motion effects are added only while the **[MOTION EFFECT]** button is held down.

There are various types of Motion Effects, such as filter effects, pitch effects, and modulation effects. For details on the different types of Motion Effects available, refer to "Motion Effect Type List" in the Data List on the website.

Specifying Motion Effect Settings

- 1 While holding down the **[SHIFT]** button, press the **[MOTION EFFECT]** button to call up the setting display.

The target part for the effect is shown in the upper display line, and the Motion Effect type is shown in the lower display line.

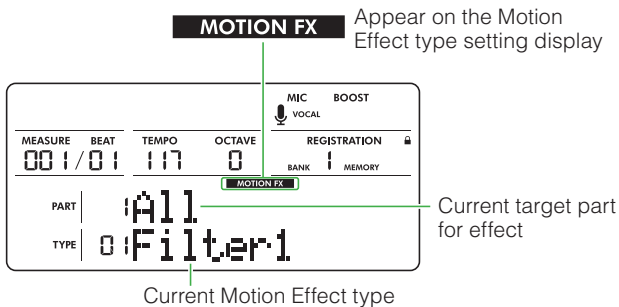
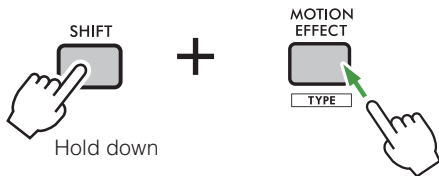

- 2 Rotate the **[VOICE]** dial to select the target part for the effect.

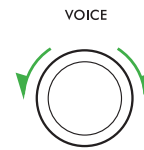

From the target parts listed below, select one for the effect.

	Display	Target Part for Effect
1	All	All parts below
2	Keyboard	Main, Dual, and Split Voices
3	Style	All parts of Style
4	Style Dr	Rhythm parts of Style
5	Style Ac	ACMP (accompaniment) parts of Style
6	Looper	Looper
7	Song	All tracks of Song
8	Sampling	Sampling pad playback
9	KbSampling	Main, Dual, and Split Voices, Sampling pad playback

- 3 Rotate the **[STYLE]** dial to select the desired Motion Effect type.

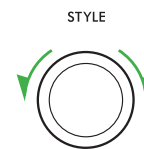

While playing the target part, hold down the **[MOTION EFFECT]** button to make sure that the effect is applied.

- 4 Press the **[SHIFT]** button to exit the setting display.

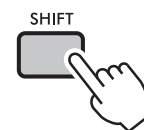

Video Manuals About Motion Effect

These show how to use Motion Effect.

https://manual.yamaha.com/mi/rt/psr-e483/videos/w/motion_effect/

Selecting a Reverb Type

The Reverb effect adds reverberation to the sound, providing, for example, a rich concert hall ambiance to your performance. Although selecting a Style or Song calls up the optimum Reverb type for the entire sound, you can select a different type as desired.

- 1 Press the [FUNCTION] button to call up the Function setting display.

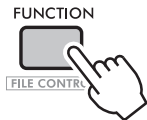

- 2 Rotate the [VOICE] dial until “Reverb” (Function 038) is shown in the upper display line.

The current Reverb type is shown in the lower display line.

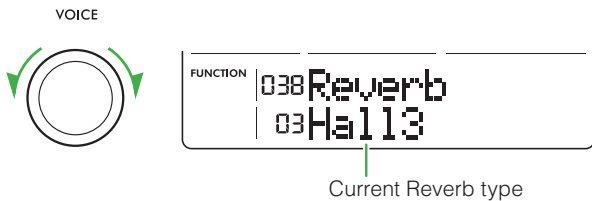

NOTE

- If a Reverb type that is only available for Songs and Styles is used, “- - -” is shown in the display.

- 3 Rotate the [STYLE] dial to select the desired Reverb type.

Play the keyboard to hear the sound. For details on the Reverb types, refer to “Reverb Type List” in the Data List on the website.

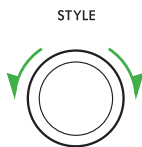

- 4 Press the [SHIFT] button to exit the Function setting display.



Adjusting the Reverb Depth

You can adjust the Reverb depth applied to the Main, Dual, and Split Voices individually in a similar way to selecting the Reverb type. In step 2, select **Function 010** for the Main Voice, **019** for the Dual Voice, or **028** for the Split Voice.

Selecting a Chorus Type

The Chorus effect adds fullness to the sound as if many Voices are being played in unison. Although selecting a Style or Song calls up the optimum Chorus type for the entire sound, you can select a different type as desired.

- 1 Press the [FUNCTION] button to call up the Function setting display.

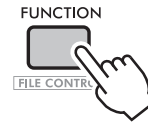

- 2 Rotate the [VOICE] dial until “Chorus” (Function 040) is shown in the upper display line.

The current Chorus type is shown in the lower display line.

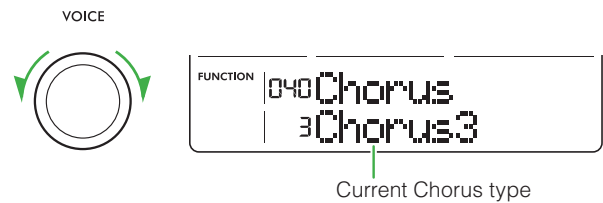

NOTE

- If a Chorus type that is only available for Songs and Styles is used, “- - -” is shown in the display.

- 3 Rotate the [STYLE] dial to select the desired Chorus type.

Play the keyboard to hear the sound. For details on the Chorus types, refer to “Chorus Type List” in the Data List on the website.

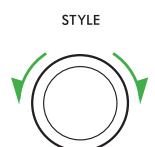

- 4 Press the [SHIFT] button to exit the Function setting display.



Adjusting the Chorus Depth

You can adjust the Chorus depth applied to the Main, Dual, and Split Voices individually in a similar way to selecting the Chorus type. In step 2, select **Function 011** for the Main Voice, **020** for the Dual Voice, or **029** for the Split Voice.

Selecting a Master EQ Setting To Achieve a Desired Sound

You can adjust the equalizer (EQ) settings to achieve the desired sound played through the built-in speakers, headphones, or external speakers.

- 1 While holding down the [SHIFT] button, press the [MEGA BOOST] button to call up the setting display.

The current Master EQ type setting is shown in the lower display line.

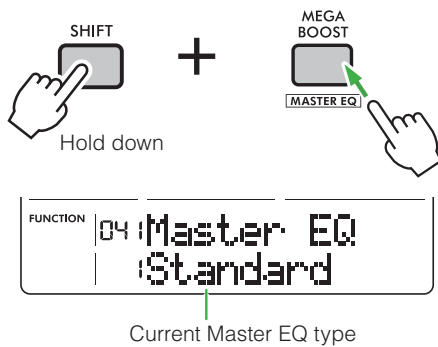

- 2 Rotate the [STYLE] dial to select the desired Master EQ type.

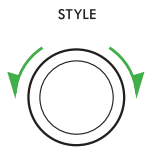

Master EQ Types

1	Standard	Provides a standard, relatively flat (unprocessed) sound. (Default setting)
2 3	Bright 1 Bright 2	This EQ setting emphasizes high-frequency sounds. The sound becomes sharp. Setting 2 produces a clearer sound than setting 1.
4 5	Mellow 1 Mellow 2	This EQ setting cuts out high-frequency sounds. The sound becomes pleasant and easy on the ears. Setting 2 produces a gentler sound than setting 1.

- 3 Press the [SHIFT] button to exit the setting display.



Using the Pitch Bend Wheel

Rotating the [PITCH BEND] wheel upward or downward while playing the keyboard smoothly raises or lowers the pitch of the notes being played. When you release the [PITCH BEND] wheel, it automatically returns to the center position, and the sound reverts to its original pitch.

You can temporarily lower the pitch by a semitone at the beginning of a phrase to create grace notes, or raise/lower the pitch after the note is produced, to recreate guitar choking techniques.

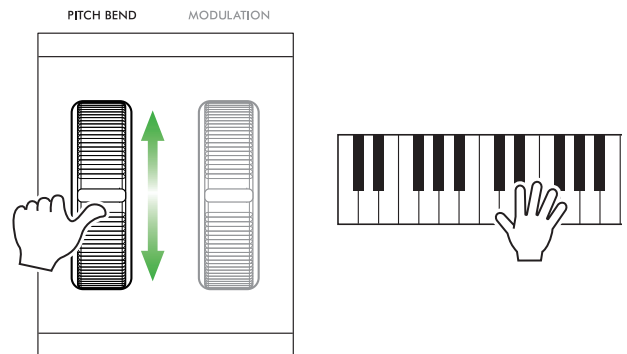

Using the Modulation Wheel (PSR-E583 only)

Use the [MODULATION] wheel to apply an effect similar to vibrato to the notes being played. Rotating the wheel upward (toward the rear) increases the intensity of the effect; rotating it downward (toward the front) decreases the intensity of the effect.

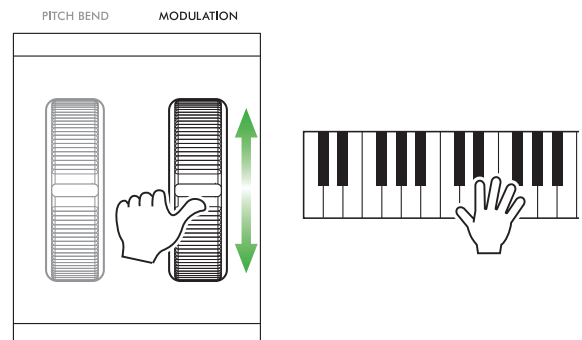

NOTE

- In order to avoid unintentionally applying vibrato during your performance, we recommend adjusting the [MODULATION] wheel to its lowest setting (down position) before you start playing.
- With Voice No. 061, 180, and 300, the vibrato effect is not applied, and the sound changes, such as to a different waveform.

Playing with Rhythm and Auto Accompaniment (Styles)

About the Auto Accompaniment Function (Style)

The Auto Accompaniment function (Style) automatically adds accompaniment (bass and phrases) that matches various rhythms and specified chords. This allows you to enjoy playing as if you were performing with a band or orchestra, even when you are playing alone.

Using the Auto Accompaniment Function (Style)

Press the MODE SELECT button to select Style mode. The STYLE indicator lights up.

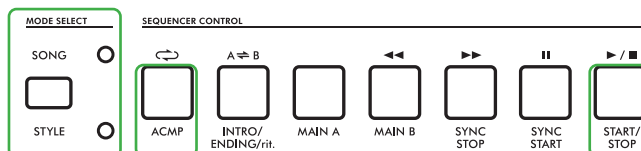

Playing an Accompaniment or Rhythm

Press the SEQUENCER CONTROL [START/STOP] button.

When the [ACMP] button is unlit

Only the rhythm is played back. The entire keyboard range can be used for playing.

When the [ACMP] button is lit

The Split Point and the area to the left of it become the “Auto Accompaniment area” and only recognizes chords. Specify chords by playing them in the Auto Accompaniment area of the keyboard.

- **When a chord is specified:** An accompaniment that matches the chords and a rhythm are played back.
- **When no chord is specified:** Only the rhythm is played back.

Split Point.....Default setting: 054 (F#2)

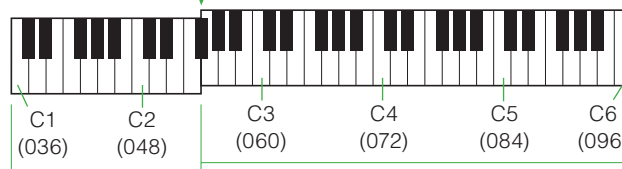

Auto Accompaniment area

You can also change the accompaniment variation, add an intro at the beginning of the performance, or add an ending at the end of the performance (page 41).

Methods for Specifying Chords During a Performance

The chords for musical instruments to play as accompaniment or rhythm can be specified using any of the following three methods. With one of these methods, the instrument automatically selects the chords. Using the method that suits you, try specifying chords to play an accompaniment or rhythm.

Methods of Playing the Keyboard To Specify Chords Yourself

Method	Fingering Type (page 36) Setting	Required Operations	Features
Multi-Finger	1 Multi Finger (default setting, page 36)	<ul style="list-style-type: none"> • Play chords with your left hand. 	This method requires you to specify chords by playing all notes of the chords for the Song that you wish to play. There is no need to start by specifying the key (Style Key) of the Song that you wish to play.
Smart Chord	2 Smart Chord (page 36)	<ul style="list-style-type: none"> • Specify the Style Key (page 37) in advance. • With your left hand, play the root note of a chord. 	This method allows you to specify chords by playing only the root notes of the chords for the Song that you wish to play. This allows you to specify a chord even if you don't know all the notes that make it up. The key (Style Key) of the Song that you wish to play must be specified in advance.

Method of Allowing the Instrument To Select Chords Automatically

Method	Fingering Type (page 36) Setting	Required Operations	Features
Auto Chord Play	N/A	<ul style="list-style-type: none"> • Specify the Style Key in advance. • Specify the Auto Chord Play type. 	This method automatically specifies chords based on the chord progressions either built into or saved onto the instrument. You can specify chords without having to play them yourself. The key (Style Key) of the Song that you wish to play must be specified in advance.

NOTE

- For details on the Style Key settings and the keys of Songs, refer to page 37.

Specifying the Chords Yourself

1 If necessary, press the **MODE SELECT** button to select Style mode.

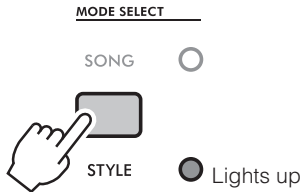

2 Rotate the **[STYLE]** dial to select the desired Style.

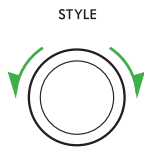

NOTE

- For Style numbers and names, refer to the Data List on the website.
- You can select not only built-in Styles but also Styles that have been loaded into the instrument from external devices (Styles 346 to 355, [page 46](#)).
- For details on making a selection in other ways than with the dial, refer to [page 13](#).

3 Press the **SEQUENCER CONTROL [ACMP]** button to turn on the Auto Accompaniment function (Style). The **[ACMP]** button lights up.

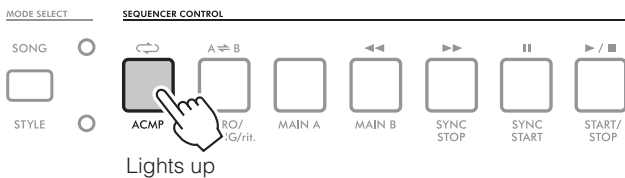

The Split Point and the area to the left of it (left-hand area of the keyboard) become the "Auto Accompaniment area" and only recognizes chords.

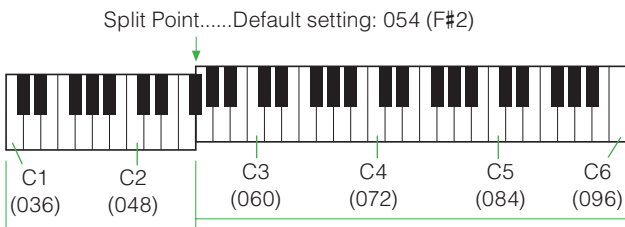

Auto Accompaniment area

The Split Point can be changed. To change it, while holding down the **[SPLIT]** button, press the desired key for the Split Point ([page 22](#)).

4 Press the **[START/STOP]** button or the **[SYNC START]** button.

- If the **[START/STOP]** is pressed
Only the rhythm part starts playing.



- If the **[SYNC START]** button is pressed
The Style starts playing back at the same time that you press a key in the keyboard (Sync Start).

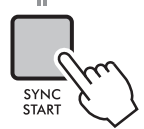

Flashes when Sync Start function is on

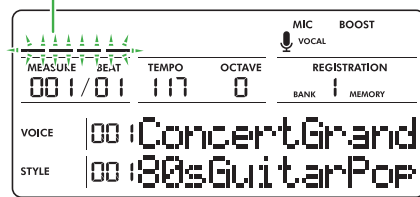

5 Play a chord in the Auto Accompaniment area to start playback of the Style.

Try playing different chords with your left hand and a melody with your right hand. There are two methods for playing the chords yourself (Fingering Type, [page 36](#)): playing all notes of the chord (Multi Finger) and playing only the root note of the chord (Smart Chord). For details on playing chords with the Multi Finger setting, refer to [page 44](#).

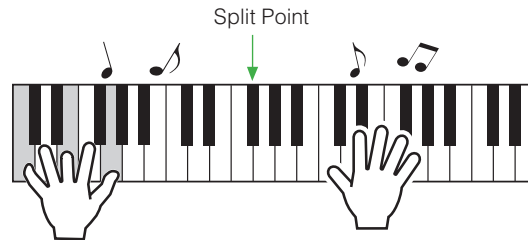

6 Press the **[START/STOP]** button to stop Style playback.



Playing Back Only the Rhythm Part

If you press the **[START/STOP]** button without first pressing the **[ACMP]** button in step 3 on [page 34](#), only the rhythm part is played back, allowing you to play the melody across the entire keyboard range.

NOTE

- If the **[ACMP]** button is lit, parts other than the rhythm part will also be played back. Press the **[ACMP]** button so that it is unlit, and then press the **[START/STOP]** button.
- For Styles that do not have any rhythm data, there will be no sound when you try to play back only the rhythm part. In that case, the accompaniment is played back only if the Auto Accompaniment function (Style) is turned on, and you play chords in the Auto Accompaniment area.

Playing Chords Without Style Playback

If you play a chord in the Auto Accompaniment area without first pressing the **[START/STOP]** button or the **[SYNC START]** button in step 4 on [page 34](#), only the chords of the Style are played back. The name of the played chord is shown in the display.

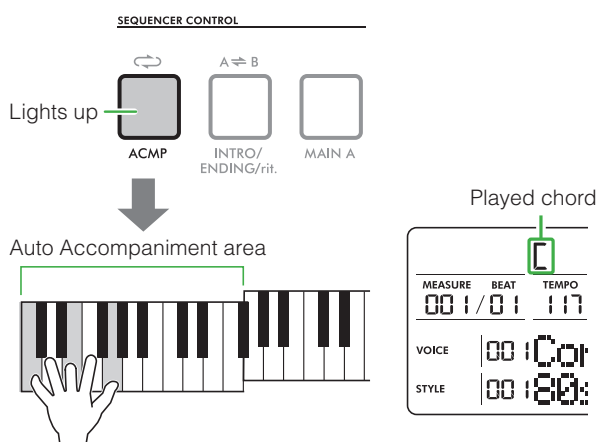

In this case, turning Harmony on ([page 25](#)) and selecting a Harmony type between 001 and 005 adds harmony to the notes played in the right-hand area of the keyboard.

Adjusting the Volume of the Style

You can adjust the volume balance between Style playback and your keyboard performance. Adjust the setting in the Function setting display ([page 107](#), [Function 030](#)).

Changing the Tempo of the Style

Refer to “Changing the Tempo” on [page 16](#).

Locking the Tempo of the Style (Tempo Lock)

When switching Styles, you can keep the playback tempo of the new Style fixed at the same tempo as the previous Style. This is useful for playback at a predetermined tempo while switching between multiple Styles.

For details, refer to the description of “Tempo Lock” ([page 104](#), [Function 001](#)) in “Function Settings.”

Selecting How Chords Are Specified When Playing Them Yourself (Fingering Type)

When playing back a Style, the method for playing chords in the Auto Accompaniment area (page 34) is called a “Fingering Type.” Select from the following two Fingering Types.

● Multi Finger (default setting)

This method requires you to specify chords by playing all notes of the chord in the Auto Accompaniment area. However, major, minor, seventh, and minor seventh chords can be played by pressing only 1 to 3 keys on the keyboard (page 44).

To play chords with the Multi Finger setting, refer to page 44.

● Smart Chord

This method allows you to specify chords (for playing back Auto Accompaniment) by playing only the root note of the chord. In order to use Smart Chord for Auto Accompaniment, the Style Key of the Song being performed should first be set (Function 032, page 37). For details on the chords played when playing a root note while using the Smart Chord setting, refer to page 45.

- 1 While holding down the [SHIFT] button, press the AUTO CHORD PLAY [ON/OFF] button.

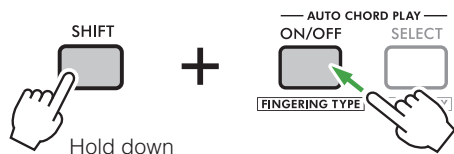

The Fingering Type setting display is called up.

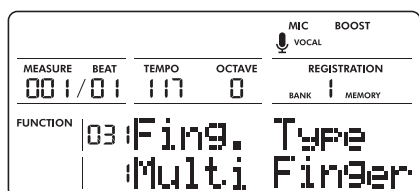

Current Fingering Type

- 2 Rotate the [STYLE] dial to select “Multi Finger” or “Smart Chord.”

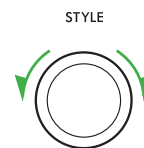

- 3 Press the [SHIFT] button to exit the Fingering Type setting display.



Specifying the Style Key (Auto Chord Play/Smart Chord)

When the Fingering Type is set to “Smart Chord,” or when specifying chords using Auto Chord Play (page 38), the Style Key of this instrument should first be set to match the key of the Song to be played. The key of a Song is determined by the number of sharps (#) or flats (b) indicated in the key signature (page 45).

- 1 While holding down the [SHIFT] button, press the AUTO CHORD PLAY [SELECT] button.

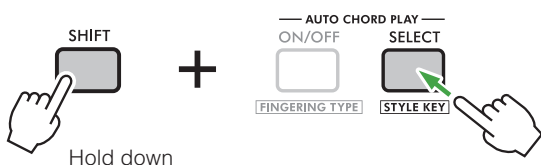

Hold down

The Style Key setting display is called up.

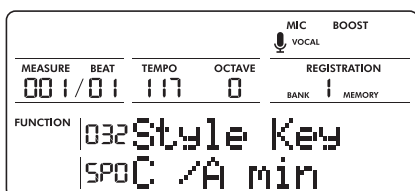

Current Style Key

- 2 Rotate the [STYLE] dial to select the Style Key that matches the sheet music.

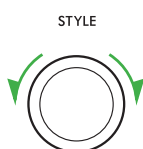

For example, if you wish to play the following sheet music, set the Style Key to “FL2 Bb/G min” (where “FL2” stands for two flats).



- 3 Press the [SHIFT] button to exit the Style Key setting display.



About the Musical Key of a Song

The “key” of a song indicates which note is the tonic (reference note) of the song and whether it is based on a major or minor scale.

To determine the key based on the sheet music, look at the key signature. The key signature indicates which notes are sharp or flat.

Since different music keys use different scales, changing the music key also changes the main keyboard keys that you play (the combination of white and black keys).

Examples:

When in C major (no key signature)



When in F major (1 flat)



As shown, the keyboard keys that you play differ depending on the music key. Note B, for example, would be played as is in C major, but as Bb in F major.

If Fingering Type is set to “Smart Chord,” the Style Key must be set to match the key of the Song that you wish to play in order to play accompaniment that corresponds to the scale (combination of keyboard keys), which differs depending on the music key.

Sheet music in F major is shown below. This sheet music in F major has one flat. In this case, set the Style Key to “FL1 F/D min” (where “FL1” stands for one flat). This allows the instrument to play accompaniment that is suitable for the key of F major.



Style Key setting display



The Style Key should also be set when using Auto Chord Play (page 38) in order for the instrument to automatically select chords. If a Style Key is specified, the chord progression will be played in a key that matches the setting.

Specifying Chords Automatically (Auto Chord Play)

The Auto Chord Play function allows you to hear chords without having to specify them yourself. The chord names appear in the display so that you can memorize the chord progression or play the melody with your right hand along with the accompaniment.

- 1 If necessary, press the **MODE SELECT** button to select Style mode.

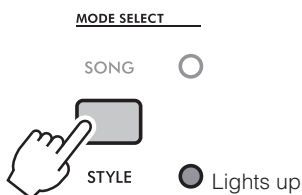

- 2 Press the **AUTO CHORD PLAY [ON/OFF]** button. **AUTO** is shown.

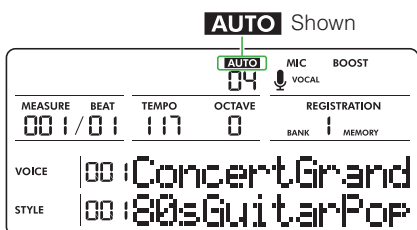
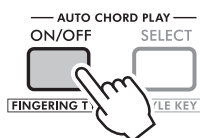

- 3 Rotate the **[STYLE]** dial to select the desired Style.

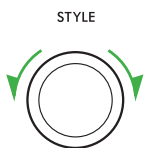

- 4 Select the appropriate **Auto Chord Play** type for your desired chord progression.

Press the **AUTO CHORD PLAY [SELECT]** button to call up the Function setting display (page 107, Function 033), and then rotate the **[STYLE]** dial to select the desired type.

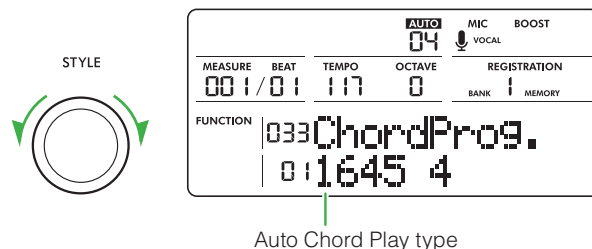
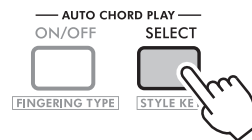

For details on the built-in Auto Chord Play types, refer to “Auto Chord Play Type List” in the Data List on the Yamaha website.

- 5 Press the **[START/STOP]** button.

The chord progression is automatically played together with an appropriate accompaniment for the chord.



Editing the Auto Chord Play Chords

If the preset Auto Chord Play type does not seem appropriate for the selected Song, you can edit the chord progression of Auto Chord Play to better match the Song.

- 1 If necessary, press the **MODE SELECT** button to select Style mode.

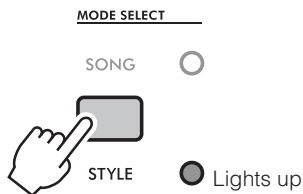

- 2 Press the **AUTO CHORD PLAY [ON/OFF]** button. **AUTO** is shown.

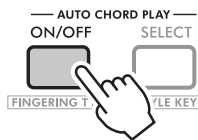

AUTO Shown

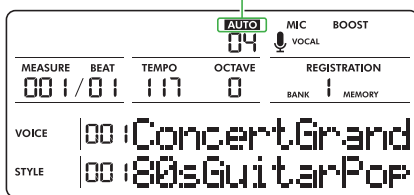

- 3 Select the Auto Chord Play type to be edited.

Press the **AUTO CHORD PLAY [SELECT]** button to call up the Function setting display (page 107, Function 033), and then rotate the **[STYLE]** dial to select the desired type.

Auto Chord Play types 94 to 100 have a chord on every beat of every measure, making it convenient for editing to your desired chord progression.

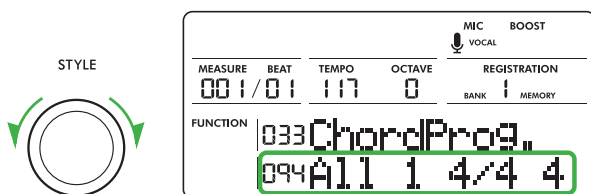
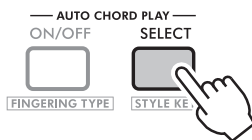

Auto Chord Play type

- 4 While holding down the **[REC]** button, press the **AUTO CHORD PLAY [SELECT]** button to call up the chord progression editing display.

The editing display called up is based on the selected Auto Chord Play type.

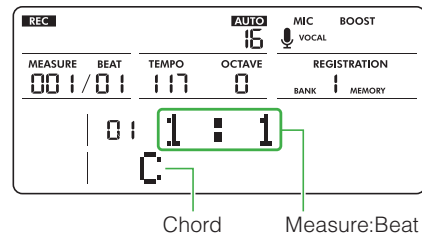
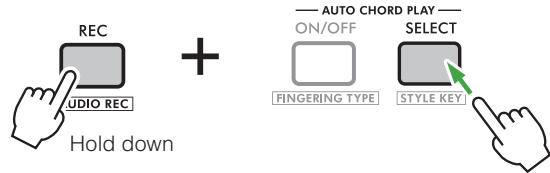

Chord Measure:Beat

(This display indicates the first beat of the first measure.)

- 5 Rotate the **[VOICE]** dial to select the measure and beat of the chord that you wish to change to a different one.

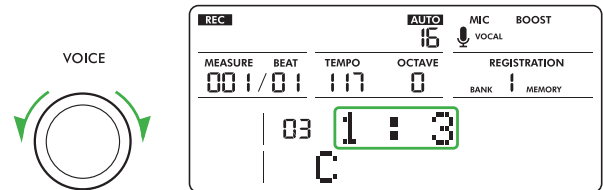

- 6 Press keys in the Auto Accompaniment area to specify the desired chord.

Split Point.....Default setting: 054 (F#2)

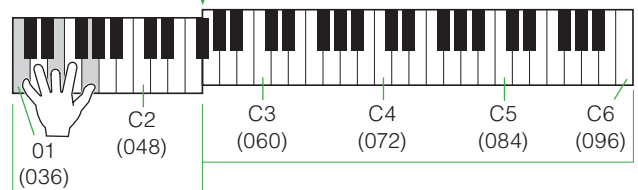

Auto Accompaniment area

The chord (at the beat in the measure) selected in step 5 changes to the specified chord.

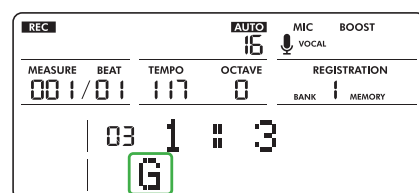

7 Repeat steps 5 to 6 to complete your desired chord progression.

8 Press the [REC] button to call up a display for selecting the save destination for the chord progression edited in steps 5 to 6.

The name of the Auto Chord Play type where the chord progression is saved is shown in the lower display line. If no chord progression has yet been saved to the save destination, "Empty" is shown to the right.

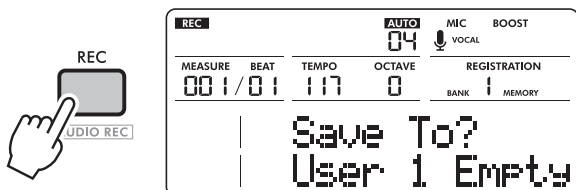

9 Rotate the [STYLE] dial to select the save destination for the chord progression.

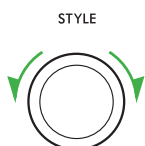

10 While holding down the [SHIFT] button, press the [+ / YES] button to save the edited chord progression.

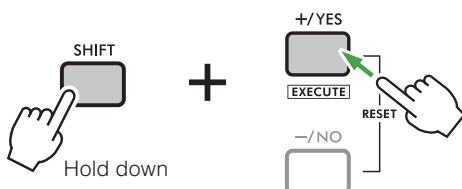

"Writing!" appears in the display, and the chord progression is saved.

11 Select the Auto Chord Play type for the saved chord progression, and then press the [START/STOP] button to hear it.

The saved chord progression is played back. If the result is different from what you expected, edit and save it again by overwriting the existing one or saving it to a different destination.

NOTE

- If the Style Key (page 37) is changed between editing and playing back chords, the chords will be played back differently from how they were edited. For example, if the Style Key is changed from SP0 to SP1, a chord set to C will change to G.

Video Manuals About Auto Chord Play

These show examples of performances using Auto Chord Play and how to edit chord progressions.

https://manual.yamaha.com/mi/rt/psr-e483/videos/w/auto_chord_play/

Using Style Playback Variations

A Style consists of the following sections (accompaniment patterns): Intro, Main A/B, Auto Fill, and Ending. The Main A/B section is played as the default pattern, but you can add variations to a performance by switching sections.

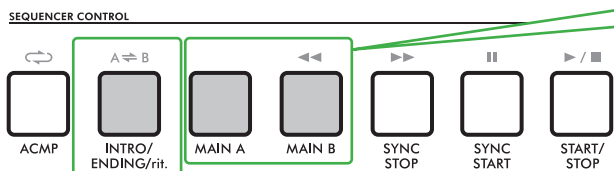

● Main A/B (Auto Fill):

Press the **[MAIN A]** or **[MAIN B]** button to play back the corresponding section repeatedly until a different section button is pressed. If, during playback, the other Main section button is pressed to switch sections, an Auto Fill (short, dynamic riff or rhythmic break) will be automatically inserted between the two sections.

● Intro:

While Style playback is stopped, press the **[INTRO/ENDING/rit.]** button to automatically play the Intro at the beginning of the performance. After finishing the Intro, playback automatically switches to either Main A or Main B.

● Ending:

During Style playback, press the **[INTRO/ENDING/rit.]** button to automatically play the Ending at the end of the performance. Style playback stops automatically at the same time that the Ending finishes. To gradually slow down (ritardando) the Ending and finish the performance, press the **[INTRO/ENDING/rit.]** button again while the Ending is being played back.

Example of a Performance Using Sections

- 1 Press the **MODE SELECT** button to select Style mode.
- 2 Rotate the **[STYLE]** dial to select the desired Style.
- 3 Press the **[ACMP]** button.
- 4 Press the **[INTRO/ENDING/rit.]** button.
- 5 Press the **[MAIN A]** button.
- 6 Press the **[SYNC START]** button.

Now, you are ready to start playback with the Intro.

● To start Style playback

- 7 Play a chord in the Auto Accompaniment area (page 34) of the keyboard.

The Intro, then Main A is played back.

[NOTE]

- To use Auto Chord Play (page 38), press the **AUTO CHORD PLAY [ON/OFF]** button, and then press the **[START/STOP]** button to start playback.

● During Style playback

- 8 Press the **[MAIN B]** button.

After an Auto Fill has been inserted, playback will switch from Main A to Main B.

● To finish Style playback

- 9 Press the **[INTRO/ENDING/rit.]** button.

The Ending is played back.

Style playback stops automatically at the same time that the Ending finishes.

Using Style Sync Stop

After the [SYNC STOP] button has been pressed to turn on this function, the Style can only be played while chords in the Auto Accompaniment area of the keyboard are played. In addition, releasing the keys stops Style playback. Press the [SYNC STOP] button again to turn off the function.

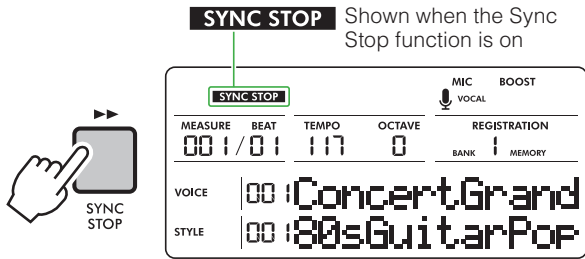

NOTE

- This function is available when the Auto Accompaniment function (Style) is on, and the SEQUENCER CONTROL [ACMP] button is lit.

Turning Each Style Track On/Off

A Style consists of multiple tracks. To play back or mute specific tracks, use the TRACK CONTROL buttons to turn individual tracks on or off.

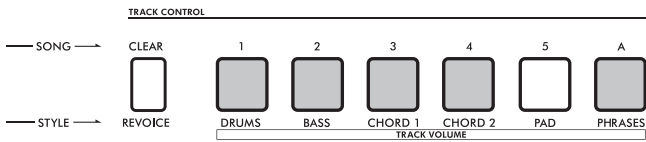

Whether each track is on or off is indicated by whether or not its button is lit.

NOTE

- Pressing multiple buttons simultaneously turns on/off no more than two tracks at the same time.
- With some Styles, the TRACK CONTROL buttons for silent tracks may light up.

Adjusting the Volume of Each Style Track Separately

The volume of each Style track can be adjusted separately. You can adjust the volume for each track not only of built-in Styles but also of Styles that have been loaded into the instrument from external devices (Styles 346 to 355, page 46).

1 If necessary, press the MODE SELECT button to select Style mode.

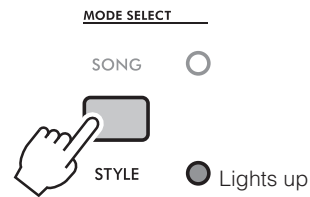

2 Rotate the [STYLE] dial to select the desired Style.

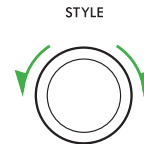

3 While holding down the [SHIFT] button, press the TRACK CONTROL button corresponding to the track whose volume you wish to adjust.

The Style track volume setting display is called up.

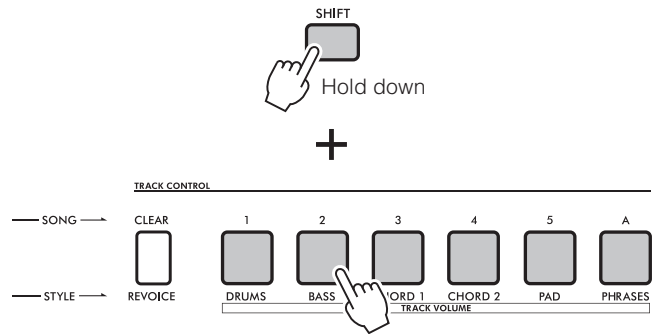

4 Rotate the [STYLE] dial to select the desired volume.

Default setting: 100
Setting range: 0 to 127

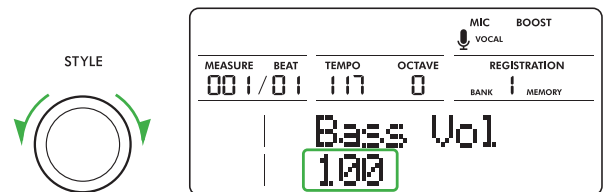

Changing the Voice Assignments of the Style Parts (Style Revoicing)

A Style consists of six tracks, each of which contains one or two parts, as shown below. With this instrument, you can change the Voice assigned to each part (such as Drum or Bass) of a Style.

Track	Part	Display indication
DRUMS	Drum1	Drum1 Voice
	Drum2	Drum2 Voice
BASS	Bass	Bass Voice
CHORD 1	Chord1	Chord1 Voice
CHORD 2	Chord2	Chord2 Voice
PAD	Pad	Pad Voice
PHRASES	Phrase1	Phrase1Voice
	Phrase2	Phrase2Voice

NOTE

- Depending on the selected Style, some of the parts listed above may not be available.

1 If necessary, press the **MODE SELECT** button to select Style mode.

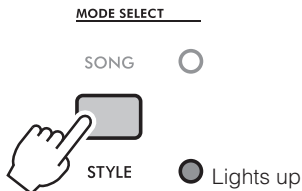

2 Rotate the **[STYLE]** dial to select the desired Style.

The **TRACK CONTROL** buttons for all tracks in the selected Style light up.

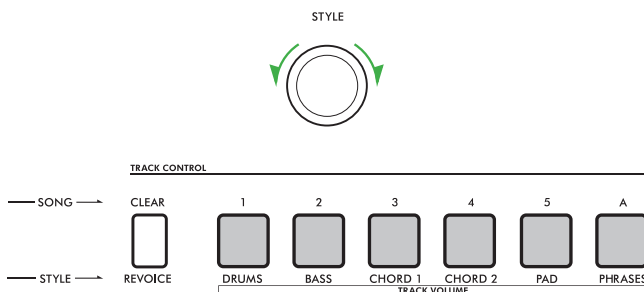

The button for each track in the Style lights up.

3 While holding down the **[REVOICE]** button, press the button corresponding to the track/part containing the Voice that you wish to change.

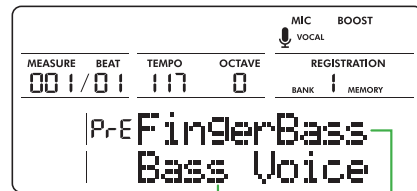
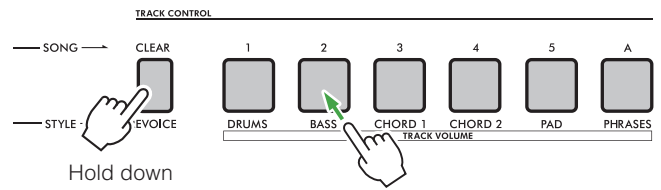

Current Voice name
Part whose Voice will be changed

NOTE

- If the Voice is the one that was originally assigned, "PrE" is shown to the left of the Voice name.
- If a track contains two parts, the setting display for the first part is called up when step 3 above is performed. To change the Voice of the second part, repeat step 3 above.

4 Rotate the **[VOICE]** dial to select the desired Voice.

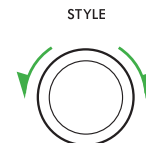

5 Play back the Style to check the sound of the Voice.

NOTE

- Because these Voice changes are only temporary, they are automatically reset when a different Style is selected. To store the changes to be recalled in the future, use the Registration Memory function (page 70).
- Voices with effects (such as DSP1, Harmony and Arpeggio) applied can be selected in step 4 above. However, the effects are turned off when those Voices are used for Style parts. As a result, the display may appear different from what was selected in step 4, but the Voice selected will be the one actually used.

Playing Chords with the Multi Finger Setting

This section describes how to play chords when Fingering Type (page 36) is set to “Multi Finger.” Since there are many useful chords and many different ways to use them musically, refer to commercially available chord books for further details.

The ★ mark indicates the root note.

Major	Minor	Seventh	Minor Seventh	Major Seventh
C 	Cm 	C7 	Cm7 	CM7
D 	Dm 	D7 	Dm7 	DM7
E 	Em 	E7 	Em7 	EM7
F 	Fm 	F7 	Fm7 	FM7
G 	Gm 	G7 	Gm7 	GM7
A 	Am 	A7 	Am7 	AM7
B 	Bm 	B7 	Bm7 	BM7

If a chord that the instrument does not recognize is played, “No chord specified” is shown. In this case, no chord name is shown in the display, and the Style played back only contains some parts (such as the rhythm).

NOTE

- Some chords (such as m7♭5) that are not included in the above table can also be specified.
- Each chord can also be specified by its inversion.
- The following chords will not be correctly specified when their inversion is played.
m7, m7♭5, m7(11), 6, m6, sus4, aug, dim7, 7♭5, 6(9), sus2
- 7sus4 can be specified by playing its inversion, but no notes can be omitted.

Major, minor, seventh, and minor seventh chords can be played by pressing only 1 to 3 keys on the keyboard.

Easy Chords for Root “C”



To play a major chord
Press the root note (★) of the chord.



To play a minor chord
Press the root note together with the nearest black key to the left of it.



To play a seventh chord
Press the root note together with the nearest white key to the left of it.



To play a minor seventh chord
Press the root note together with the nearest white and black keys to the left of it (all three keys at the same time).

Chords Specified with the Smart Chord Setting

If Fingering Type is set to “Smart Chord,” and the Style Key has been set according to the key signature of the sheet music (page 37), chords are specified as follows when the root key is pressed in the Auto Accompaniment area of the keyboard.

Key Signature of Sheet Music	Style Key	Root Note											
		C#/D \flat		D#/E \flat		F#/G \flat		G#/A \flat		A#/B \flat			
		C	D	E	F	G	A	B					
 FL7 C \flat /A \flat min	Cdim	D \flat m	Ddim7	E \flat 1+5	E	Fdim	G \flat 7	G	A \flat m	A	B \flat m7 \flat 5	B	
 FL6 G \flat /E \flat min	Cdim	D \flat 7	D	E \flat m	E	Fm7 \flat 5	G \flat	Gdim	A \flat m	Adim7	B \flat 1+5	B	
 FL5 D \flat /B \flat min	Cm7 \flat 5	D \flat	Ddim	E \flat m	Edim7	F1+5	G \flat	Gdim	A \flat 7	A	B \flat m	B	
 FL4 A \flat /F min	C1+5	D \flat	Ddim	E \flat 7	E	Fm	G \flat	Gm7 \flat 5	A \flat	Adim	B \flat m	Bdim7	
 FL3 E \flat /C min	Cm	D \flat	Dm7 \flat 5	E \flat	Edim	Fm	F \sharp dim7	G1+5	A \flat	Adim	B \flat 7	B	
 FL2 B \flat /G min	Cm	C \sharp dim7	D1+5	E \flat	Edim	F7	G \flat	Gm	A \flat	Am7 \flat 5	B \flat	Bdim	
 FL1 F/D min	C7	D \flat	Dm	E \flat	Em7 \flat 5	F	F \sharp dim	Gm	G \sharp dim7	A1+5	B \flat	Bdim	
No key signature 	SP0 C/A min (Default setting)	C	C \sharp dim	Dm	D \sharp dim7	E1+5	F	F \sharp dim	G7	A \flat	Am	B \flat	Bm7 \flat 5
 SP1 G/E min	C	C \sharp dim	D7	E \flat	Em	F	F \sharp m7 \flat 5	G	G \sharp dim	Am	A \sharp dim7	B1+5	
 SP2 D/B min	C	C \sharp m7 \flat 5	D	D \sharp dim	Em	Fdim7	F \sharp 1+5	G	G \sharp dim	A7	B \flat	Bm	
 SP3 A/F \sharp min	Cdim7	C \sharp 1+5	D	D \sharp dim	E7	F	F \sharp m	G	G \sharp m7 \flat 5	A	A \sharp dim	Bm	
 SP4 E/C \sharp min	C	C \sharp m	D	D \sharp m7 \flat 5	E	Fdim	F \sharp m	Gdim7	G \sharp 1+5	A	A \sharp dim	B7	
 SP5 B/G \sharp min	Cdim	C \sharp m	Ddim7	D \sharp 1+5	E	Fdim	F \sharp 7	G	G \sharp m	A	A \sharp m7 \flat 5	B	
 SP6 F \sharp /D \sharp min	Cdim	C \sharp 7	D	D \sharp m	E	Fm7 \flat 5	F \sharp	Gdim	G \sharp m	Adim7	A \sharp 1+5	B	
 SP7 C \sharp /A \sharp min	Cm7 \flat 5	C \sharp	Ddim	D \sharp m	Edim7	F1+5	F \sharp	Gdim	G \sharp 7	A	A \sharp m	B	

NOTE

- A “1+5” chord is shown in the display like its major triad.
- These are the chord names that appear in the instrument’s display. They differ from the notation on some commercially available sheet music.

Loading Style Files from External Devices

Style files (.sty) created on another instrument or a computer can be loaded to Styles 346 to 355, and played in the same way as built-in Styles.

The following two Load operations are available.

- Loading a Style file (.sty) saved in the root directory of a USB flash drive
- Loading a Style file (.sty) transferred from a computer to the internal memory of this instrument

This section describes how to load data from a USB flash drive.

For details on transferring a Style file from a computer, refer to [page 100](#). After data transfer is finished, follow steps 2 to 7 below to load it onto this instrument.

NOTICE

- Before using a USB flash drive, be sure to read “Precautions for Using the [USB TO DEVICE] Terminal” ([page 12](#)).
- Loading a Style file overwrites and erases the existing data at the destination Style number. To keep important data, save it as a separate file onto a USB flash drive before loading.

- 1 Connect a USB flash drive to the [USB TO DEVICE] terminal, and make sure that **USB :** is shown (lit continuously) in the upper right of the display.



- 2 While holding down the [SHIFT] button, press the [FUNCTION] button to call up the File Control display.

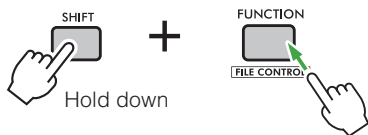

- 3 Rotate the [VOICE] dial until “Load Style” (File Control Operation 004) is shown in the upper display line.

The name of the file to be loaded and the name of the device where that file is stored are shown in the lower display line. If necessary, rotate the [STYLE] dial to select the Style file to be loaded.

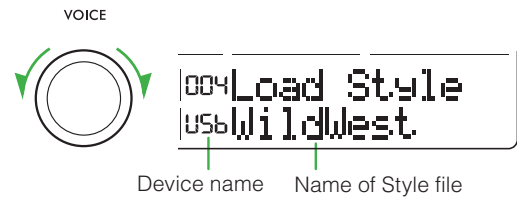

- 4 While holding down the [SHIFT] button, press the [+ / YES] button.

“***Load To?” (where “***” is a Style number between 346 and 355, to which the data will be loaded) is shown in the lower display line. To load the data to a different Style number, rotate the [STYLE] dial to select the desired number.

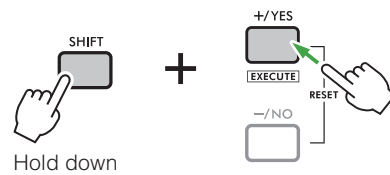

- 5 While holding down the [SHIFT] button, press the [+ / YES] button again.

“Load OK?” is shown in the lower display line for confirmation to execute the Load operation. To cancel the Load operation, press the [- / NO] button.

- 6 Press the [+ / YES] button to execute the Load operation.

“Loading” appears in the lower display line while the operation is being executed.

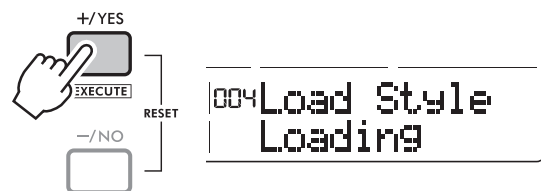

When the Load operation is finished, “Complete” is shown in the lower display line.

NOTICE

- The Load operation cannot be cancelled while it is being executed. Never turn off the instrument or disconnect the USB flash drive during the operation. Otherwise, data may be lost.

- 7 To exit the File Control display, press the [SHIFT] button.

- 8 To play back the loaded Style, press the MODE SELECT button to select Style mode (if necessary), and then select the Style number.

Changing the Sound with the Knobs

The two knobs can be used to add variations to the sound being played, transforming the sound in a variety of musical ways.

Using the Knobs

This is an example using the default functions assigned to the two knobs.

1 Rotate the [VOICE] dial to select the Voice to be played with the keyboard.

In this example, we will use Voice No. 281 (“Gemini”).



2 Press the [ASSIGN] button.

The part where the sound is changed with the knobs is shown in the upper display line, and the functions currently assigned to knobs [A] and [B] are shown in the lower display line.

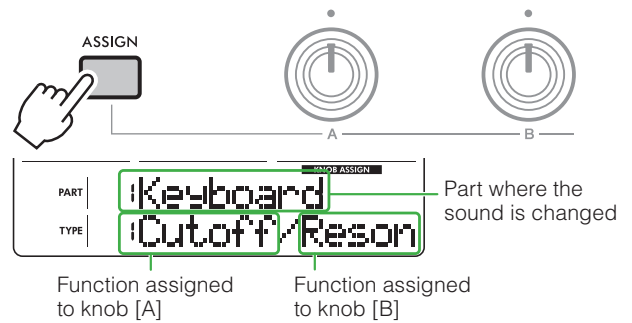

For details on changing the part where the sound is changed and the functions assigned to the knobs, refer to [page 48](#).

3 While playing the keyboard, turn knobs [A] and [B].

This creates dynamic filter-sweep effects like with an analog synthesizer.

Suggested Uses

When the target part is “1 Keyboard”

1	Cutoff/ Resonance	Select Voice No. 281 (PSR-E583)/256 (PSR-E483) (“Gemini”) or No. 315 (PSR-E583)/287 (PSR-E483) (“Noise”). Turning knobs [A] and [B] while playing the keyboard creates dynamic filter-sweep effects like with an analog synthesizer.
2	Reverb/ Chorus	Select Voice No. 013 (“CP80”). Turn knobs [A] and [B] fully counterclockwise to hear the sound with no effect applied. Turning knob [B] clockwise gradually applies a Chorus effect to the sound. Turning knob [A] clockwise adds a Reverb effect, creating a sound as if you were playing in a concert hall.
3	Main/ Dual Volume	Turns on the Dual Voice. Select Voice No. 014 (“Piano&Strs”). Turning knob [A] adjusts the volume of the Main Voice (Piano) and knob [B] adjusts the volume of the Dual Voice (Strings). You can separately adjust the volume of both the Main and Dual Voices in order to change the balance between them.
4	DSP1	Select Voice No. 057 (PSR-E583)/049 (PSR-E483) (“JazzLight”). In the DSP 1 type setting display (page 28), set the DSP 1 type to “01 D RotSpSlow.” Turning knob [A] while playing the keyboard changes the rotating speed of the rotary speakers. Slowly turning the knob changes the rotating speed gradually, just like actual rotary speakers. Turning knob [B] adjusts the volume balance of the rotary speakers.

When the target part is “2 Backing”

1	Cutoff/ Resonance	Select Voice No. 131 (“MainFloor”) or No. 132 (“TranceElectro”). Turning knobs [A] and [B] during Style playback allows you to enjoy performing like a DJ.
2	Reverb/ Chorus	Select Style 035 (“6/8ChartBld”) or Style 073 (“SoulR&B”). Turn knobs [A] and [B] fully counterclockwise to hear the direct, unprocessed sound of the Voice. Turning knob [B] clockwise gradually applies a Chorus effect to the sound. Turning knob [A] clockwise adds a Reverb effect, creating a sound as if you were playing in a concert hall.

When the target part is “3 System”

	DSP2	Select Style 068 (“DancePop2”), and turn on DSP 2. In the DSP 2 type setting display (page 28), select “12 CrossDelay.” During Style playback, turning knob [A] adjusts the feedback and knob [B] adjusts the delay time, allowing you to adjust the amount of delay applied. If multiple sounds overlap and sound unnatural, turn knob [A] counterclockwise.
--	------	---

Specifying Knob Settings

You can select the part where the sound is changed with the knobs as well as the function assigned to each knob.

As shown in the table below, the assignable functions and their targets differ depending on the selected part. The targets of each function are automatically determined based on the selected part and function.

Target Part	Functions (Knob A/ Knob B)	Target of Function
1 Keyboard	1 Cutoff/Resonance	Main Voice, Dual Voice
	2 Reverb/Chorus	Main Voice, Dual Voice
	3 Main/Dual Volume	Main Volume: Main Voice Dual Volume: Dual Voice
	4 DSP1 Parameter A/B	Main Voice
2 Backing	1 Cutoff/Resonance	Style
	2 Reverb/Chorus	Style
	3 Tempo/ Volume Balance	Tempo: Style Volume balance: Style, Song, Audio input from external device
3 System	DSP2 Parameter A/B	Part selected in DSP 2 type setting display (page 28)

For details on the functions that can be assigned to the knobs, refer to page 49.

1 Press the [ASSIGN] button to call up the setting display.

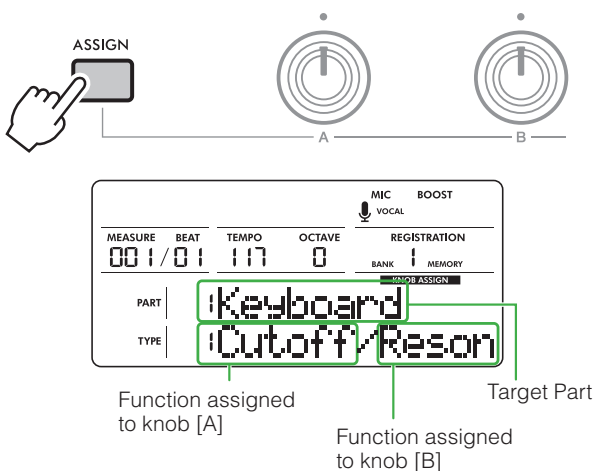

2 Rotate the [VOICE] dial to select the target part.
Default setting: 1 Keyboard

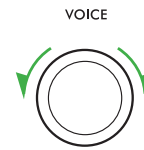

3 Rotate the [STYLE] dial to select the functions to be assigned to the knobs.

For details on the assignable functions, refer to page 49.

Default setting: 1 Cutoff/Resonance

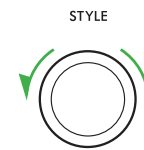

NOTE

- Simply changing the assigned function will not change the sound, even if the knob is not at its center position. The selected function is only applied when the knob is turned.
- Depending on the panel settings and how the knobs are turned, the instrument may behave unexpectedly, such as the effect being difficult to perceive when the knobs are turned, or noise being generated.
- Some DSP 1 effects do not change, even if that function is assigned to a knob and the knob is turned.

4 To hear how the sound changes, turn the knobs.

Video Manuals About Knobs

These show how to use the knobs.

<https://manual.yamaha.com/mi/rt/psr-e483/videos/w/knobs/>

Functions Assignable to the Knobs

This section describes the functions that can be assigned to the knobs.

When the target part is “1 Keyboard”

1 Cutoff/Resonance

These functions change the tone by cutting audio signals above a specific frequency band or creating a distinctive sound using a resonance effect. Here, we will try creating some popular synthesizer filter effects.

● Knob [A]: Cutoff

Changes the brightness of the sound by adjusting the filter’s cutoff frequency (which determines the frequency range above which signals will be cut off). Turning the knob clockwise produces a brighter sound.

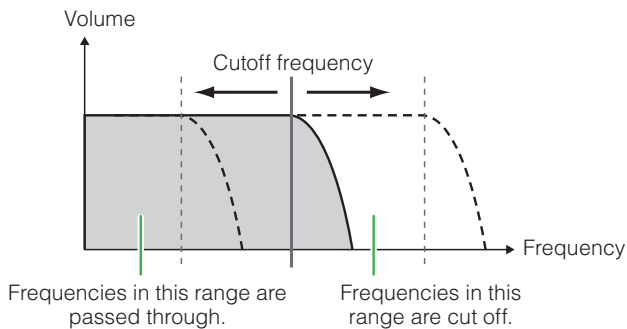

● Knob [B]: Resonance

Changes the resonance effect (which boosts audio signals near the cutoff frequency, adding a distinctive character to the sound). Turning the knob clockwise increases the Resonance to emphasize the frequencies at the cutoff frequency, resulting in an exaggerated peak.

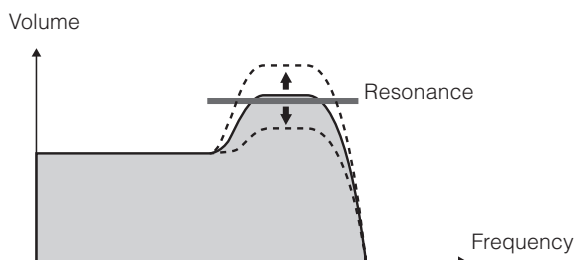

2 Reverb/Chorus

● Knob [A]: Reverb

Allows you to experience the immersive feeling of performing in a concert hall or live music venue. Turning the knob clockwise increases the depth.

● Knob [B]: Chorus

Produces a rich, full sound, as if multiple parts were being played simultaneously. Turning the knob clockwise increases the depth.

3 Main/Dual Volume

● Knob [A]: Main Volume

● Knob [B]: Dual Volume

Turning knob **[A]** adjusts the volume of the Main Voice and knob **[B]** adjusts the volume of the Dual Voice.

Turning the knob clockwise raises the volume; turning the knob counterclockwise lowers the volume.

4 DSP1 Parameter A/B

Controls the DSP 1 effect applied to the Main Voice.

Each effect has two parameters that can be assigned, one for knob **[A]** and one for knob **[B]**.

When the target part is “2 Backing”

1 Cutoff/Resonance

For details on the function, refer to “1 Cutoff/Resonance” at the left.

2 Reverb/Chorus

For details on the function, refer to “2 Reverb/Chorus” at the left.

3 Tempo/Volume Balance

● Knob [A]: Tempo

Turning the knob clockwise increases the tempo of Style playback; turning the knob counterclockwise decreases the tempo.

● Knob [B]: Volume Balance

Turning the knob clockwise decreases the volume of the backing part (Style or Song); turning the knob counterclockwise decreases the volume of the input from the external device (**[USB TO HOST]** terminal or **[AUX IN]** jack). Changes the volume balance between the backing part (Style or Song) and the external input, or between the backing part/external input and the keyboard/Quick Sampling pads.

NOTE

- When “Audio Loopback” ([Function 071](#) (PSR-E583)/[Function 070](#) (PSR-E483)) is set to “Off,” the volume of the audio input from the external device connected to the **[USB TO HOST]** terminal cannot be adjusted.

When the target part is “3 System”

DSP2 Parameter A/B

Controls the effect applied to the part selected in DSP 2 type setting display ([page 28](#)). Each effect has two parameters that can be assigned, one for knob **[A]**

and one for knob **[B]**.

Specifying Scale Tuning (Temperament) Settings

By default, the pitch of each keyboard key is set to Equal Temperament—the same tuning as on a standard acoustic piano. This keyboard can be set to other musical temperaments to match the music genre in which you wish to play or your specific purpose.

Selecting a Preset Temperament

You can select the desired temperament from the various presets.

- 1 Press the [FUNCTION] button to call up the Function setting display.

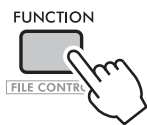

- 2 Rotate the [VOICE] dial until “Scale” (Function 056 (PSR-E583)/Function 055 (PSR-E483)) is shown in the upper display line.

The current temperament is shown in the lower display line.

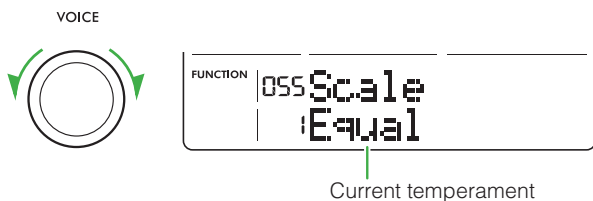

- 3 Rotate the [STYLE] dial to select the temperament.

Default setting: 1Equal

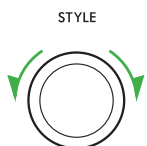

Preset Temperament Types

1	Equal
2	Pure Major
3	Pure Minor
4	Bayat (Arabic)
5	Rast (Arabic)

- 4 Press the [SHIFT] button to exit the Function setting display.



Selecting the Base Note for the Temperament

You can change the base note (reference pitch) of the temperament. When a Temperament setting other than “Equal” has been selected, or an original temperament has been created by using the Tune Note function, you should select the appropriate base note (or tonic).

- 1 Press the [FUNCTION] button to call up the Function setting display.



- 2 Rotate the [VOICE] dial until “Base Note” (Function 057 (PSR-E583)/Function 056 (PSR-E483)) is shown in the upper display line.

The current base note is shown in the lower display line.

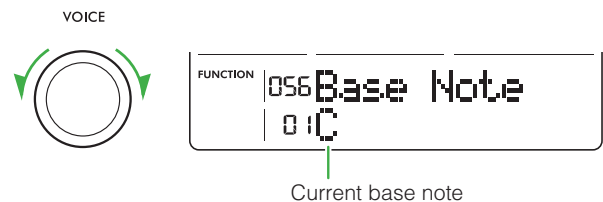

- 3 Rotate the [STYLE] dial to select a base note from the following.

Default setting: C

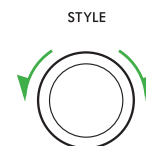

Number	Base Note	Number	Base Note
01	C	07	F#/G♭
02	C#/D♭	08	G
03	D	09	G#/A♭
04	D#/E♭	10	A
05	E	11	A#/B♭
06	F	12	B

- 4 Press the [SHIFT] button to exit the Function setting display.



Tuning Each Note to Create an Original Scale

You can tune the individual notes in cents (a “cent” is 1/100th of a semitone) to create your own original scale.

- 1 Press the [FUNCTION] button to call up the Function setting display.

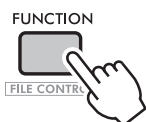

- 2 Rotate the [VOICE] dial until “Tune Note” (Function 058 (PSR-E583)/Function 057 (PSR-E483)) is shown in the upper display line.

The current target note for tuning is shown in the lower display line.

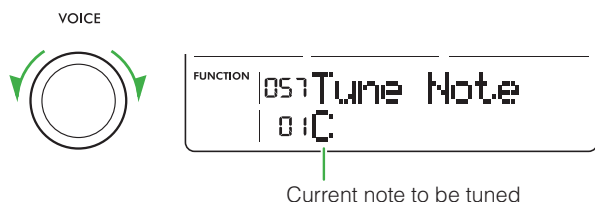

- 3 Rotate the [STYLE] dial to select the note to be tuned from the following.

Default setting: C

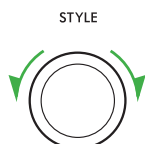

Number	Target note	Number	Target note
01	C	07	F#/Gb
02	C#/Db	08	G
03	D	09	G#/Ab
04	D#/Eb	10	A
05	E	11	A#/Bb
06	F	12	B

- 4 Press the [+] button. “Tune XX” is shown in the upper display line.

“XX” is the note selected in step 3.

The tuning value for the selected note is shown in the lower display line.

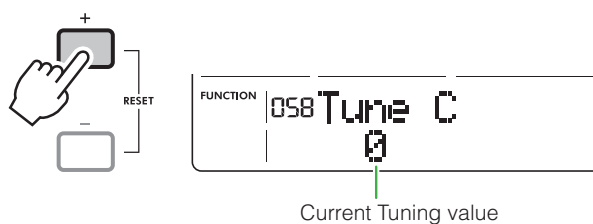

- 5 Rotate the [STYLE] dial to tune the note within the range of -64 to +63 cents.

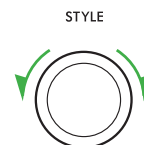

To revert an edited value to its default setting, simultaneously press the [+ / YES] and [- / NO] buttons.

NOTE

- The default setting for each note is defined by the settings of the last loaded temperament from those listed below.
 - Preset temperament selected with “Scale” (Function 056 (PSR-E583)/Function 055 (PSR-E483))
 - An “(Edited)” original temperament loaded from Registration Memory, where it had been saved after being edited

- 6 Repeat steps 2 to 5 as necessary.

- 7 Press the [SHIFT] button to exit the Function setting display.



- 8 If desired, save your settings to a Registration Memory.

By saving the settings, you can recall your original scale later.

For details on saving (registering), refer to [page 70](#).

NOTE

- If “Scale” (Function 056 (PSR-E583)/Function 055 (PSR-E483)) is called up after tuning individual notes, “(Edited)” is shown in the display. Rotating the dial at that time causes “(Edited)” to disappear, the edited temperament settings are cleared, and one of the presets between 1 and 5 is shown.

Playing Back Songs (MIDI Data) or Audio Files

With this instrument, you can play back Songs (MIDI data) and audio files. In addition to listening to the playback, you can play the keyboard along with the Song or audio file playback.

Songs (MIDI Data)

On this instrument, “Song” refers to all MIDI data, including Preset Songs and commercially available song data. MIDI data is comprised of your keyboard performance information, such as pressing/releasing keys, etc. The performance information refers to which keys are played, at what timing, and at what strength—just as in a musical score—and is not a recording of the actual sound itself. Based on the recorded performance information, the tone generator outputs the corresponding sound. Since information such as keyboard parts and Voices is also recorded, individual parts can be turned on and off and Voices can be changed. This makes it a very useful tool for practicing.

With this instrument, you can export a User Song ([page 60](#)) from the internal memory onto a USB flash drive as a MIDI file. In addition, you can play back external MIDI files as a Song by transferring the files from a computer into the internal memory using Storage Mode ([page 100, 112](#)), or by connecting a USB flash drive (containing the files) to the instrument. This instrument can play back SMF (Standard MIDI File) format data.

Song Category

The Songs are categorized according to their characteristics.

Song Number	Song Category	
001–002	Demo	Yamaha original Songs that give you an idea of the advanced capabilities of this instrument.
003–012	User	Songs that you have recorded yourself (page 60).
013–	Downloads	Songs transferred to this instrument from a computer, etc. Song data as well as the Song Book, which contains the sheet music for the song data, can be downloaded from the Yamaha website. For details on downloading, refer to page 2 .
	USB	Songs on the USB flash drive. Files in folders on the USB flash drive as far as two levels down can be recognized. In addition, there are restrictions on the characters that can be used in file names. For details on the folder structure of USB flash drives and the characters that can be used in file names, refer to page 91 .

NOTE

- For Songs 013 and up, numbers are assigned in the following order: Songs transferred from a computer, Songs on the USB flash drive. A Song transferred to this instrument from a computer, etc., is inserted in front of the first USB Song, renumbering the USB Songs accordingly.
- Songs that are larger than 250 KB cannot be played back.

Audio Files

An audio file is a recording of the performed sound itself. This data can be played with a portable music player, etc., allowing you to easily let other people listen to your performance.

This instrument can play back audio files (WAV format of 44.1 kHz, 16-bit, stereo) stored on a USB flash drive.

Playing Back a Demo Song

While holding down the [SHIFT] button, press the [PORTABLE GRAND] button.

Demo Songs 001 to 002 are played back in sequence. Playback will repeat continuously, starting again from the first Song (001).

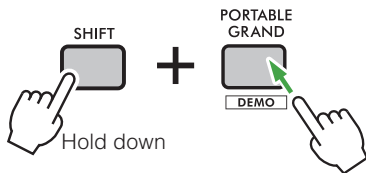

To stop playback, press the [▶ / ■] (Start/Stop) or [SHIFT] button.

NOTE

- When Demo Song playback is started using the above operation, the previous or next Demo Song cannot be selected by rotating the [STYLE] dial. To select a different Demo Song, press the [+ / YES] or [- / NO] button.

Playing Back a Song (MIDI Data)

1 If necessary, press the MODE SELECT button to select Song mode.

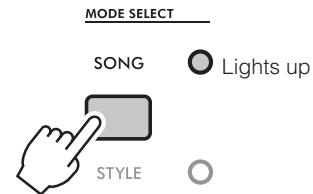

2 Rotate the [STYLE] dial to select the Song that you wish to play back.

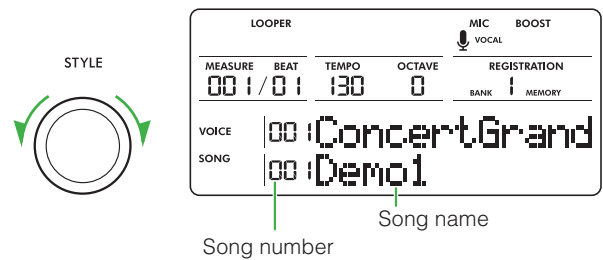

NOTE

- For details on making a selection in other ways than with the dial, refer to [page 13](#).

3 To start playback of the Song, press the [▶ / ■] (Start/Stop) button.



4 To stop playback, press the [▶ / ■] (Start/Stop) button again.

Adjusting the Song Volume

You can adjust the volume balance between Song playback and your keyboard performance. Adjust the setting in the Function setting display ([page 107](#), [Function 034](#)).

Changing the Song Tempo

Refer to “Changing the Tempo” on [page 16](#).

Playing Back an Audio File from a USB Flash Drive

NOTICE

- Before using a USB flash drive, be sure to read “Precautions for Using the [USB TO DEVICE] Terminal” (page 89).
- Do not disconnect the USB flash drive or turn off the instrument during playback of an audio file. Otherwise, the data may be damaged.

1 Connect a USB flash drive to the [USB TO DEVICE] terminal.

2 While holding down the [SHIFT] button, press the [SONG] button. **AUDIO** is shown.

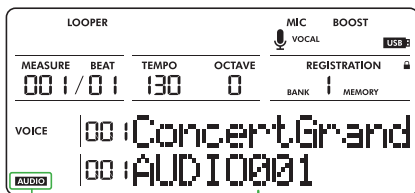
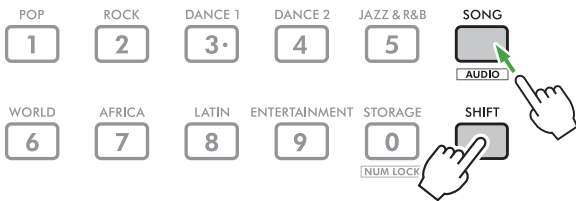

AUDIO Lights up Audio file name

3 Rotate the [STYLE] dial to select the desired audio file for playback.

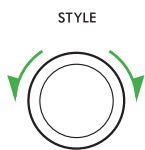

NOTE

- For details on making a selection in other ways than with the dial, refer to page 13.

4 Press the [▶ / ■] (Start/Stop) button to start playback of the audio file.

During playback, “PLY” and the amount of time that has elapsed are shown in the display.

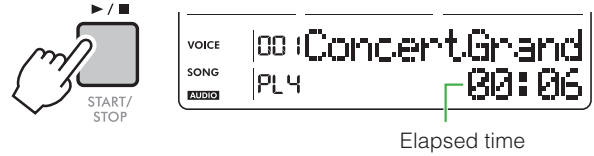

NOTE

- The following operations cannot be performed during audio file playback.
 - Changing the Voice
 - A-B Repeat
 - Muting a track
 - Changing the tempo

List of Error Messages Related to Audio File Playback

Message	Description
No USB	No USB flash drive is connected.
No File	There is no audio file in the USB flash drive.
Can't Use	Playback is not possible because the USB flash drive cannot be recognized.
Error Load	Cannot load the audio file because the format is not compatible with this instrument. Only files in the WAV format (44.1 kHz, 16-bit, stereo) can be played back on this instrument.

5 To stop playback, press the [▶ / ■] (Start/Stop) button again.

Song/Audio File Transport Controls: Fast Forward, Fast Reverse, and Pause

[▶▶] (Fast Forward) button

During playback, press this button to rapidly skip ahead to a later point in the Song or audio file. With a Song, pressing this button while playback is stopped increases the measure number.

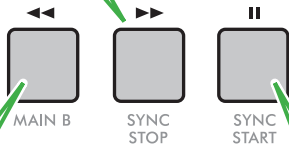

[◀◀] (Fast Reverse) button

During playback, press this button to rapidly return to an earlier point in the Song or audio file. With a Song, Fast Reverse returns in one-measure increments. Pressing this button while playback is stopped decreases the measure number.

[||] (Pause) button

During playback, press this button to pause the Song or audio file. Press it again to continue playback from that point.

NOTE

- If A-B Repeat (Refer to the following.) has been set during playback of a Song, Fast Forward and Fast Reverse can only be used within the range between A and B.
- Fast-reversing a Song while DSP 2 is on may result in the DSP2 effect not functioning or sounding as expected. If this happens, turn DSP 2 off, then on again, or stop playing the Song to restore the DSP 2 effect.

Playing a Specified Section of a Song Repeatedly (A-B Repeat)

You can play back only a specific section of a Song (MIDI data) repeatedly by setting the start point (A) and end point (B) in one-measure increments.

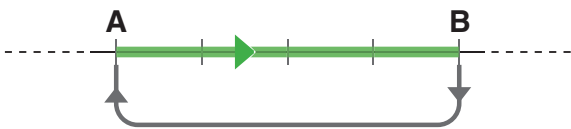

- 1 If necessary, press the **MODE SELECT** button to select Song mode.

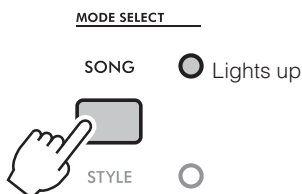

- 2 Press the [▶ / ■] (Start/Stop) button to start playback of a Song (MIDI data) (page 53).



- 3 When playback reaches the point that you wish to specify as the start point (A), press the [A ⇌ B] (A-B Repeat) button.

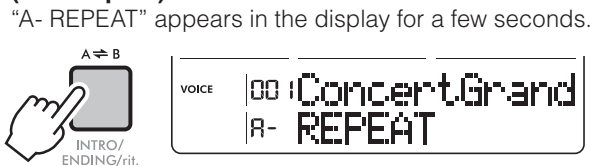

NOTE

- To set the start point (A) at the beginning of the Song, press the [A ⇌ B] (A-B Repeat) button before starting playback in step 2.

- 4 When playback reaches the point that you wish to specify as the end point (B), press the [A ⇌ B] (A-B Repeat) button again.

The specified A-B section of the Song will now play repeatedly. "A-bREPEAT" appears in the display for a few seconds, and **A ⇌ B** is shown.

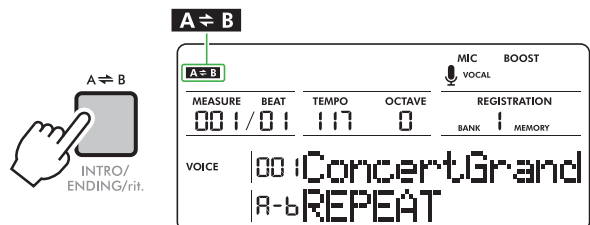

NOTE

- To set the end point (B) at the end of the Song, specify only the start point (A), and then play back the Song to the end.

- 5 To cancel repeat playback, press the [A ⇌ B] (A-B Repeat) button again.

"OFFREPEAT" appears in the display for a few seconds.



- 6 Press the [▶ / ■] (Start/Stop) button to stop Song playback.

Playing a Recorded Phrase (User Song) Repeatedly

You can repeatedly play (Loop playback) a phrase that you recorded as a User Song (page 60). Before recording a User Song, specify the number of measures to record (page 64) for smooth, seamless Loop playback.

- 1 If necessary, press the **MODE SELECT** button to select Song mode.

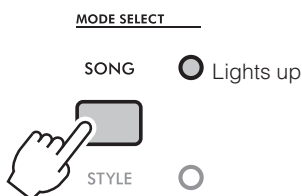

- 2 Rotate the **[STYLE]** dial to select the recorded User Song (Song 003 to 012) for Loop playback.

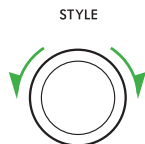

- 3 Press the **[↻]** button to turn on Loop playback.

The **[↻]** button lights up.



- 4 Press **[▶ / ■]** (Start/Stop) button to start playback of the Song.

When the currently selected Song reaches the end, playback automatically returns to the beginning of the Song and repeats indefinitely. Playback continues until the **[▶ / ■]** (Start/Stop) button is pressed again. To cancel Loop playback, press the **[↻]** button again.

NOTE

- When Loop playback returns to the beginning of a Song, the Voice, for example, may play back differently than at the beginning of recording. This is because the last setting made during recording will be the one used in Loop playback.

Changing the Melody Voice of a Song

You can change the Melody Voice of Songs downloaded from the Yamaha website (page 2), as well as MIDI Songs from an external device, such as a USB flash drive.

- 1 If necessary, press the **MODE SELECT** button to select Song mode.

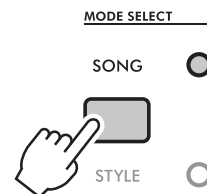

- 2 Rotate the **[STYLE]** dial to select the Song whose Voice you wish to change.

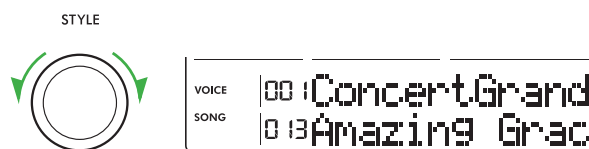

NOTE

- The Voice for Songs 003 and up can be changed. The Voices for Demo Songs 001 and 002 cannot be changed.
- For details on making a selection in other ways than with the dial, refer to page 13.

- 3 Rotate the **[VOICE]** dial to select the desired Voice.

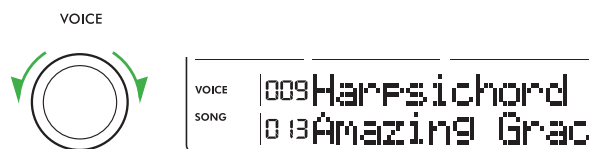

- 4 Press the **[FUNCTION]** button.

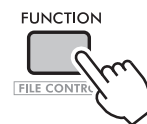

- 5 Rotate the **[VOICE]** dial until “MelodyVcChg” (Function 035) is shown in the upper display line. “YES?” is shown in the lower display line for confirmation to change the Voice.

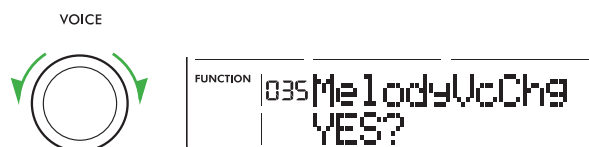

NEXT PAGE

6 Press the [+ / YES] button.

The current Voice name is shown in the upper display line. "SONG MELODY VOICE" scrolls in the lower display line.

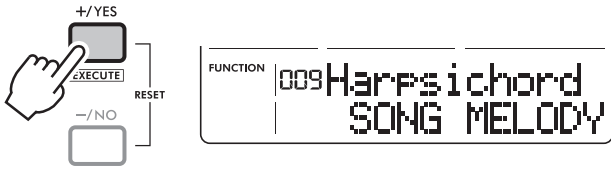

7 Press the [SHIFT] button to return to the home display (page 14).

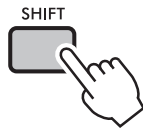

8 To start playback of the Song, press the [▶ / ■] (Start/Stop) button.



NOTE

- The Voice reverts to its original setting when a different Song is selected.

Muting Each Track Separately

Each track of a Song plays different parts, such as the melody, rhythm, and accompaniment. Each of the tracks can be muted so that you can play the muted part yourself. To mute a track, press the corresponding button ([1] to [5], [STYLE]). To unmute the track, press the same button again.

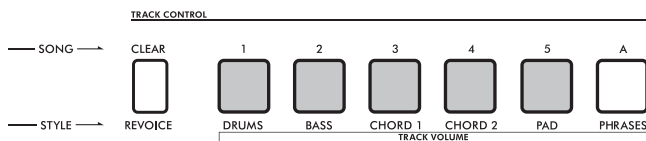

Whether or not each track is muted is indicated by whether or not its button is lit.

NOTE

- Pressing multiple buttons simultaneously turns on/off no more than two tracks at the same time.

Adjusting the Volume of Each Song Track Separately

The volume of each Song track can be adjusted separately.

1 If necessary, press the MODE SELECT button to select the Song mode.

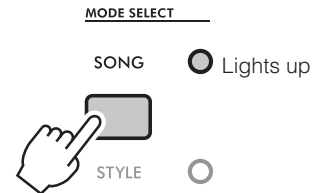

2 Rotate the [STYLE] dial to select the desired Song.

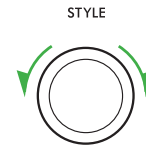

3 While holding down the [SHIFT] button, press the TRACK CONTROL button corresponding to the track whose volume you wish to adjust.

The Song track volume setting display is called up.

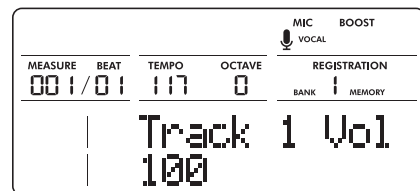
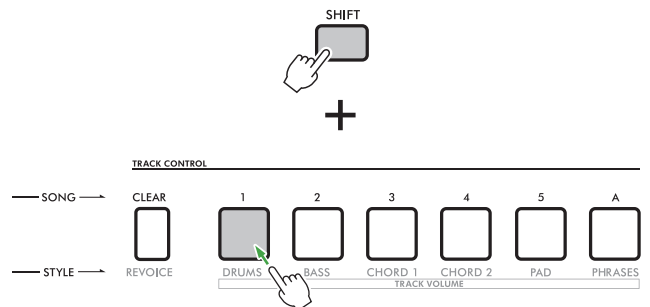

4 Rotate the [STYLE] dial to select the desired volume.

Default setting: 100
Setting range: 0 to 127

Connecting and Using a Microphone

By connecting a microphone to the [MIC INPUT] jack, you can sing along with your keyboard performance while applying reverb and chorus effects to your vocals. Sound that is input from the microphone is played from the built-in speakers. You can also switch to the Talk setting when you wish to talk between songs.

CAUTION

- Before connecting the instrument to external devices, turn off all of the devices. In addition, before turning the instrument on or off, make sure that all volume levels are set to the minimum. Otherwise, damage to the devices or electrical shock may occur.

NOTE

- Be sure to use a dynamic microphone.

Connecting a Microphone

- 1 Before turning the instrument on, turn the [MASTER VOLUME] control fully counterclockwise, to "MIN."

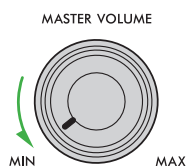

- 2 Set the [GAIN] knob on the rear panel (page 12) to the center position.

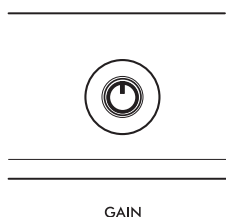

- 3 Connect a microphone with a standard mono phone plug to the [MIC INPUT] jack on the rear panel. If the microphone has a switch, switch it on before step 4.

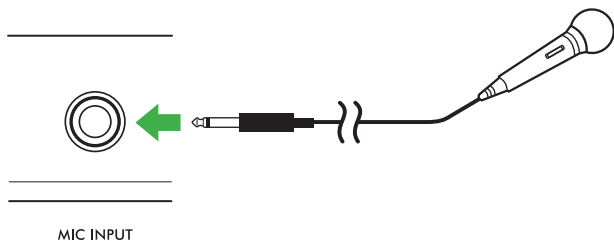

- 4 Turn the instrument on.
- 5 Adjust the overall volume with the [MASTER VOLUME] control.
- 6 While holding down the [SHIFT] button, press the [MIC] button to call up the Mic Volume setting display.



- 7 While singing into the microphone, rotate the [STYLE] dial to adjust the volume of the microphone.

If you cannot obtain a suitable microphone volume by turning this dial, adjust the [GAIN] knob on the rear panel.

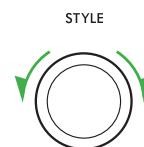

- 8 Press the [SHIFT] button to exit the Mic Volume setting display.
- 9 Sing into the microphone while playing the keyboard and playing back a Song.

Changing the Microphone Setting

You can switch to the Talk setting with the press of a button, for example, when you want to add conversation between songs during a concert. This is referred to as a “Mic type” setting. Each press of the **[MIC]** button changes the setting to one of three Mic types.

Mic Type

VOCAL	Reverb and chorus effects are applied to the microphone's audio. Microphone panning (position where audio is heard; page 108, Function 043) can also be specified.
TALK	Reverb and chorus effects are not applied to the microphone's audio. Mic Pan is set to “C” (center).
MUTE	The microphone's audio is turned off.

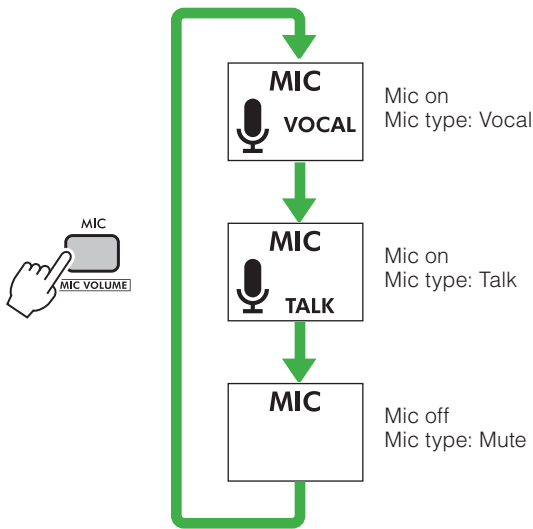

Panning the Microphone

You can adjust the microphone's pan (position) setting. Specify the setting in the Function setting display ([page 108, Function 043](#)).

Adding Reverb and Chorus to the Microphone

You can add vocal effects to the microphone, such as Reverb to make it sound as if you are singing in a concert hall, or Chorus to add depth and natural movement to your voice. Specify the setting in the Function setting display ([page 108](#)).

- Reverb:[Function 044](#)
- Chorus:[Function 045](#)

Disconnecting the Microphone

- 1 Turn the **[MASTER VOLUME]** control fully counterclockwise, to “MIN.”

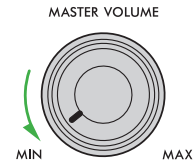

- 2 Turn the instrument off.
- 3 Disconnect the microphone from the **[MIC INPUT]** jack.

Recording Your Performance

Methods for Recording Onto This Instrument

This instrument can record your performances in two different ways.

Song Recording (MIDI Recording)

You can record your performance as MIDI data to the internal memory. This instrument allows you to record and erase each track (part) separately, making editing easy. Songs recorded using this method are called “User Songs.” You can record a maximum of 10 User Songs and up to a total of about 19,000 notes. In addition, User Songs can be exported to a USB flash drive as MIDI files, which can be played and edited on other MIDI devices or sequencers ([page 66](#)).

Audio Recording

You can save your performance as an audio file in the WAV format to a USB flash drive. You can also record audio from the **[MIC INPUT]** jack, the **[AUX IN]** jack, and the **[USB TO HOST]** terminal. Audio files are in WAV format (44.1 kHz, 16 bit, stereo), and the maximum recording time is 80 minutes. This recorded audio file can also be played back on computers and smart devices.

Recording a Performance as a New User Song (MIDI Recording)

This section explains how to record to the instrument's internal memory without specifying a track. You can record up to 10 of your own performances as User Songs (User 1 to 10: Song 003 to 012). For details on playing recorded User Songs, refer to "Playing Back a Song (MIDI Data)" on [page 53](#).

- 1 If necessary, press the **MODE SELECT** button to select Song mode.

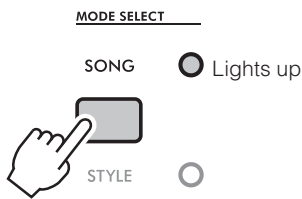

- 2 Rotate the **[STYLE]** dial to select the User Song number (Song 003 to 012) to which the recorded data is to be saved.



NOTICE

- If data has already been saved to the selected User Song number, the corresponding **TRACK CONTROL** button lights up. Continuing to record will delete the existing data and overwrite it with the new data.

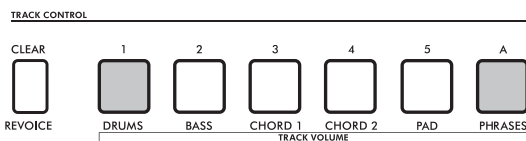

Buttons for tracks containing data light up

- 3 Select a mode according to the content that you wish to record.

- When recording only a melody performance: Song mode
- When recording a performance using a Style: Style mode

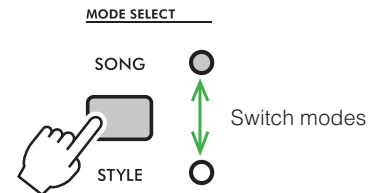

NOTE

- In Style mode, the **TRACK CONTROL** button corresponding to the currently selected Style data lights up.

- 4 Specify the desired panel settings, such as the **Main Voice** ([page 20](#)).

- 5 Press the **[REC]** button to enter Record Standby mode.

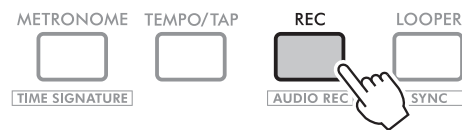

REC Flashes when in Record Standby mode

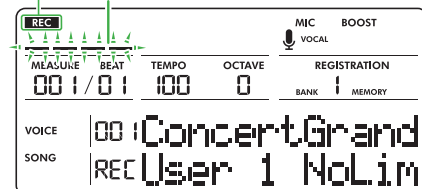

NOTE

- In Record Standby mode, the on/off status of **ACMP** cannot be changed.

To exit Record Standby mode, press the **[REC]** button again.

NEXT PAGE

6 Depending on the content that you wish to record, play the keyboard or press the [▶ / ■] (Start/Stop) button to start recording.

- **When recording only a melody performance:**
Play the keyboard to start recording.
- **When recording the accompaniment and rhythm of a Style:**
 - Play a chord in the Auto Accompaniment area (page 34) to start recording with Style playback.
 - Press the [▶ / ■] (Start/Stop) button to start recording with Style playback.
At first, only the rhythm is played back. After you play the keyboard, the accompaniment is played back, allowing you to record both the accompaniment and the rhythm.
By switching sections (page 41) without playing the keyboard, you can record only the rhythm.
To also record an Intro while recording only the rhythm, press the [INTRO/ENDING/rit.] button, then the [▶ / ■] (Start/Stop) button.

NOTE

- **(PSR-E583 only)**
Recording a Style while adjusting the volume with the foot controller may use a large amount of recording capacity, which could prevent data from being saved. When recording a Style while using the foot controller, we recommend one of the following solutions.
 - Set the part whose volume is to be adjusted by the foot controller to “2 Keyboard” (page 110, Function 055).
The settings for the part whose volume is to be adjusted can be saved to Registration Memory (page 70). For example, you can conserve recording capacity by recording the settings for “1 All” in Memory 1 and for “2 Keyboard” in Memory 2, then switching between Memory 1 and 2 as needed.
 - Recording audio (page 68)

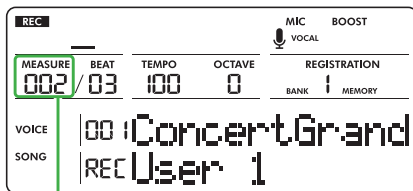

Current measure

The current measure is shown in the display while recording.

Limitations When Recording a User Song

- The on/off status of ACMP cannot be changed.
- The Style number cannot be changed.
- While recording a Style, the following parameters cannot be changed: Reverb Type, Chorus Type, Time Signature, and Style Volume.
- Performances with Quick Sampling pads [A] to [D] cannot be recorded.
- The audio input from an external device (playback sound on a connected computer or audio device) cannot be recorded.

7 Press the [▶ / ■] (Start/Stop) or [REC] button to stop recording.

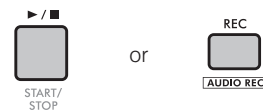

When recording has been stopped, “Writing!” appears in the display and the data is saved.

NOTICE

- Never attempt to turn off the instrument or unplug the AC adaptor while “Writing!” is shown. Otherwise, data may be lost.

NOTE

- While recording a Style, you can also stop playback and recording by pressing the [INTRO/ENDING/rit.] button.

8 To play back the recorded performance, press the [▶ / ■] (Start/Stop) button.

To later play back the recorded Song, select its Song number (003 to 012) in step 2 of “Playing Back a Song (MIDI Data)” on page 53.

NOTE

- To save the User Song onto a USB flash drive, refer to page 66.

Recording Each Track (Part) Separately

This section explains how to record a User Song to a specified track (part). This is useful, for example, when you want to record additional performances to an already recorded User Song, or re-record only one track of an already recorded User Song.

Track Structure of a Song

A Song contains six tracks (parts).

● Melody Tracks [1] to [5]

For recording melody performances.

● Accompaniment Track [A]

For recording a chord progression of a Style.

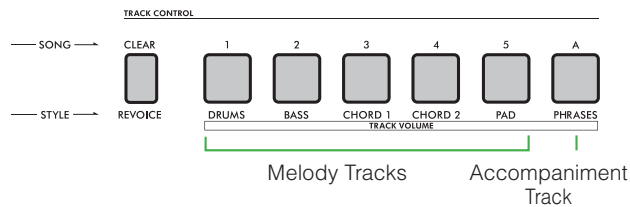

When you make a recording without specifying a track, the melody is recorded to Track [1], and the accompaniment (Style chords) is recorded to Track [A]. At this time, if a recorded User Song had already been selected, the data on Track [1] and Track [A] for that Song will be overwritten. You can also record each track one by one (e.g., only the right-hand part or the left-hand part) to create a complete piece that may be difficult to play all at once.

1 If necessary, press the MODE SELECT button to select Song mode.

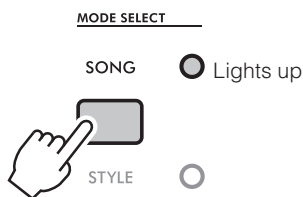

2 Rotate the [STYLE] dial to select the User Song number (Song 003 to 012) to which the recorded data is to be saved.

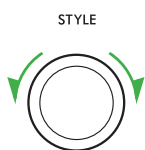

NOTICE

- If data has already been saved to the selected User Song number, the corresponding TRACK CONTROL button lights up. Continuing to record will delete the existing data and overwrite it with the new data.

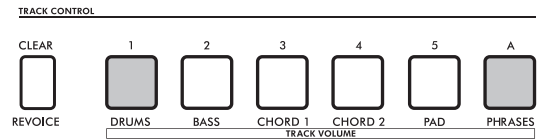

Buttons for tracks containing data light up

3 Specify the track to record and overwrite, and enter Record Standby mode.

● To record only the melody:

While holding down the [REC] button, press the button for the track that you wish to record to ([1] to [5]).

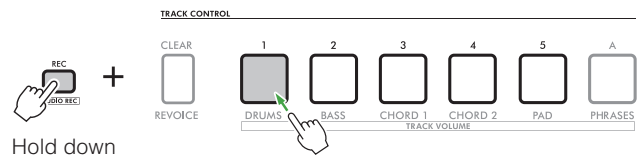

● To record only the Style:

Press the **MODE SELECT** button to select the Style mode, and select the desired Style. While holding down the [REC] button, press the [A] button. ACMP is automatically turned on.

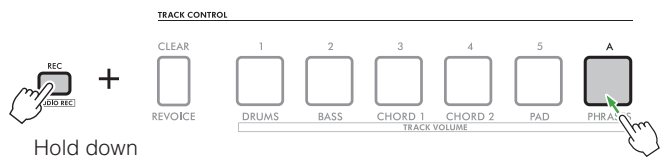

NOTE

- In Style mode, the TRACK CONTROL button corresponding to the currently selected Style data lights up.

4 Specify the desired panel settings, such as the Main Voice (page 20).

5 Depending on the content that you wish to record, play the keyboard or press the [▶ / ■] (Start/Stop) button to start recording.

Similar to when recording a new Song, the procedure differs depending on whether you are recording only the melody or recording a Style. For details, refer to step 6 on [page 62](#).

NOTE

- If the internal memory becomes full while recording, an alert message appears, and recording stops automatically. In this case, delete unnecessary data by using the Clear function ([page 65](#)), and then try recording again.

6 Press the [▶ / ■] (Start/Stop) or [REC] button to stop recording.

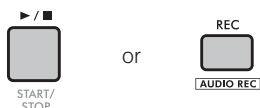

When recording has been stopped, “Writing!” appears in the display and the data is saved.

NOTICE

- Never attempt to turn off the instrument or unplug the AC adaptor while “Writing!” is shown. Otherwise, data may be lost.

7 To play back the recorded performance, press the [▶ / ■] (Start/Stop) button.

To later play back the recorded Song, select its Song number (003 to 012) in step 2 of “Playing Back a Song (MIDI Data)” on [page 53](#).

NOTE

- To save the User Song onto a USB flash drive, refer to [page 66](#).

Specifying the Number of Measures To Record

During Loop playback ([page 56](#)) of a User Song, specify the number of measures before recording.

1 Perform steps 1 to 5 of “Recording a Performance as a New User Song (MIDI Recording)” ([page 61](#)).

2 Rotate the [STYLE] dial to specify the number of measures to be recorded.

Setting range: NoLim (not specified) to Len 32 (32 measures)



3 Depending on the content that you wish to record, play the keyboard or press the [▶ / ■] (Start/Stop) button to start recording.

Similar to when recording a new Song, the procedure differs depending on whether you are recording only the melody or recording a Style. For details, refer to step 6 on [page 62](#).

4 When the performance reaches the specified number of measures, recording stops automatically.

5 To play back the recorded performance, press the [▶ / ■] (Start/Stop) button. ([page 53](#))

For Loop playback, press the [↔] button before pressing the [▶ / ■] (Start/Stop) button. The [↔] button lights up, and Loop playback is turned on.

Deleting a User Song (Song Clear)

This lets you clear all tracks of a User Song.

- 1 If necessary, press the **MODE SELECT** button to select Song mode.

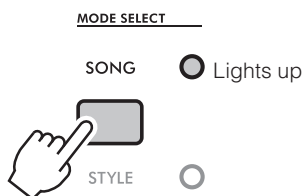

- 2 Rotate the **[STYLE]** dial to select the User Song (Song 003 to 012) whose data you wish to delete.

- 3 Press the **[CLEAR]** button.

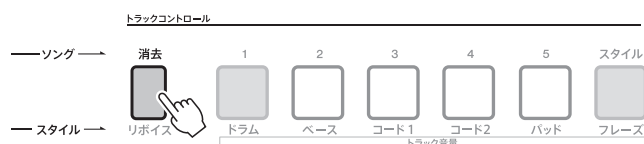

A confirmation message appears in the display.

Clear User1
YES/NO?

- 4 Press the **[+/YES]** button.

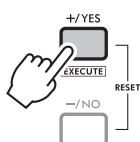

A message appears for confirmation to delete the data of the User Song.

To cancel the operation, press the **[-/NO]** button.

Clear User1
Sure? YES/NO

- 5 Press the **[+/YES]** button again to delete the data.

"Writing!" appears in the display, and the data of the User Song is deleted.

Clearing a Specified Track from a User Song (Track Clear)

This lets you clear individual tracks of a recorded User Song.

- 1 If necessary, press the **MODE SELECT** button to select Song mode.

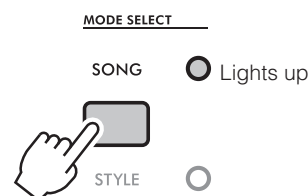

- 2 Rotate the **[STYLE]** dial to select the User Song (Song 003 to 012) whose data you wish to delete.

- 3 While holding down the **[CLEAR]** button, press the button ([1] to [5], [Style]) for the track that you wish to clear.

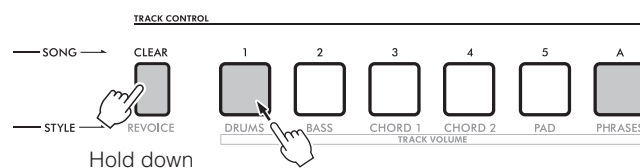

A confirmation message appears in the display.

Clear Track1
YES/NO?

- 4 Press the **[+/YES]** button.

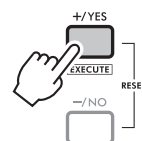

A message appears for confirmation to clear the track. To cancel the operation, press the **[-/NO]** button.

Clear Track1
Sure? YES/NO

- 5 Press the **[+/YES]** button again to delete the data.

"Writing!" appears in the display, and the selected Track is deleted.

Saving a User Song as a MIDI File onto a USB Flash Drive

A User Song (page 60) can be converted to SMF (Standard MIDI File) format 0 and saved onto a USB flash drive.

NOTICE

- Before using a USB flash drive, be sure to read “Precautions for Using the [USB TO DEVICE] Terminal” (page 89).

NOTE

- The DSP effect cannot be converted to the SMF format.
- The Transpose setting specified with this instrument is not included in the data.

- 1 Connect a USB flash drive to the [USB TO DEVICE] terminal, and make sure that **USB** is shown (lit continuously) in the upper right of the display.



- 2 While holding down the [SHIFT] button, press the [FUNCTION] button to call up the File Control display.

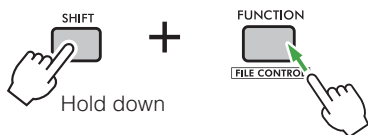

- 3 Rotate the [VOICE] dial until “Save SMF” (File Control Operation 005) is shown in the upper display line.

The name of a User Song is shown in the lower display line as “User **” (where “**” is a number between 1 and 10). To select a different User Song, rotate the [STYLE] dial to select from User 1 to User 10.



- 4 While holding down the [SHIFT] button, press the [+ / YES] button.

An available name for the file to be saved onto the USB flash drive is shown in the lower display line as “SONG****” (where “****” is a number between 001 and 100). To select a different file, rotate the [STYLE] dial to select from SONG001 to SONG100.

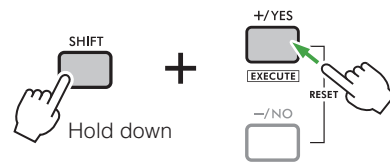

- 5 While holding down the [SHIFT] button, press the [+ / YES] button again.

“Save OK?” is shown in the lower display line for confirmation to execute the Save operation. To cancel the Save operation, press the [- / NO] button.

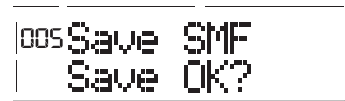

Overwriting Existing Files

If data had already been saved to the selected file, “Overwrite?” is shown in the lower display line.

- 6 Press the [+ / YES] button again to execute the Save operation.

“Saving” appears in the lower display line while the operation is being executed. After a while, a message indicating completion of the operation appears, and a User file (.usr) is saved to a “USER FILES” folder that was automatically created on the USB flash drive.



When the Save operation is finished, “Complete” is shown in the lower display line. The “USER FILES” folder is automatically created on the USB flash drive.

NOTICE

- The Save operation cannot be cancelled while it is being executed. Never turn off the instrument or disconnect the USB flash drive during the operation. Otherwise, data may be lost.

NOTE

- The amount of time required for this operation may vary depending on the condition of the USB flash drive.

- 7 To exit the File Control display, press the [SHIFT] button.

Deleting a MIDI File from a USB Flash Drive

MIDI files recorded on this instrument and saved onto a USB flash drive can be deleted individually.

NOTICE

- Before using a USB flash drive, be sure to read “Precautions for Using the [USB TO DEVICE] Terminal” (page 89).

NOTE

- Only SMF files (.mid) saved in the “USER FILES” folder on the USB flash drive can be deleted. Files saved outside the folder are not recognized. This operation applies only to files named with the format “SONG***” (where “***” is a number between 001 and 100).

- 1 Connect a USB flash drive to the [USB TO DEVICE] terminal, and make sure that **USB :** is shown (lit continuously) in the upper right of the display.



- 2 While holding down the [SHIFT] button, press the [FUNCTION] button to call up the File Control display.

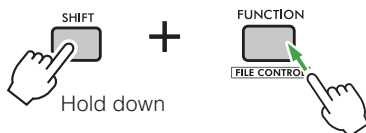

- 3 Rotate the [VOICE] dial until “Delete SMF” (File Control Operation 006) is shown in the upper display line.

The name of a MIDI file on the USB flash drive is shown in the lower display line as “SONG***” (where “***” is a number between 001 and 100). If necessary, rotate the [STYLE] dial to select the User file to be deleted.



- 4 While holding down the [SHIFT] button, press the [+ / YES] button.

“Delete OK?” is shown in the lower display line for confirmation to execute the Delete operation. To cancel the Delete operation, press the [- / NO] button.

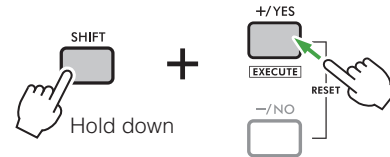

- 5 Press the [+ / YES] button to execute the Delete operation.

“Deleting” appears in the lower display line while the operation is being executed.



When the Delete operation is finished, “Complete” is shown in the lower display line.

NOTICE

- The Delete operation cannot be cancelled while it is being executed. Never turn off the instrument or disconnect the USB flash drive during the operation. Otherwise, data may be lost.

- 6 To exit the File Control display, press the [SHIFT] button.

Recording a Performance as an Audio File onto a USB Flash Drive

This lets you record your performances to a USB flash drive as audio files.

NOTICE

- Before using a USB flash drive, be sure to read “Precautions for Using the [USB TO DEVICE] Terminal” (page 89).

NOTE

- When using the audio recording function, be sure to use an AC adaptor. The audio recording function is not available when using batteries.
- For details on the messages that are shown in the display during recording, refer to page 69.

- 1 Connect a USB flash drive to the [USB TO DEVICE] terminal, and make sure that **USB** is shown (lit continuously) in the upper right of the display.



- 2 Press the MODE SELECT button to select either Song or Style mode.

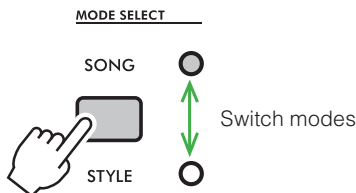

To record a performance using a Style, select the Style mode.

- 3 Specify the desired settings for the performance that you wish to record.

Depending on the mode selected in step 2, the data that can be recorded is limited to the following.

- With Song mode
Keyboard performance, audio input from the [MIC INPUT]/[AUX IN]/[USB TO HOST] connectors
- With Style mode
Style, keyboard performance, audio input from the [MIC INPUT]/[AUX IN]/[USB TO HOST] connectors

- 4 While holding down the [SHIFT] button, press the [REC] button to enter Record Standby mode for audio recording.

AUDIO is shown in the lower left of the display.

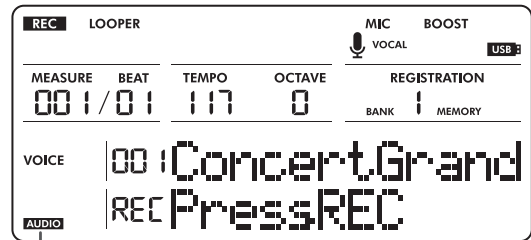

AUDIO Lights up

To exit Record Standby mode, while holding down the [SHIFT] button, press the [REC] button.

- 5 Press the [REC] button to start recording.

The amount of time that has elapsed is shown in the display while recording. The maximum recording time is 80 minutes or until the USB flash drive is full, whichever is shorter. When recording a Style, press the [START/STOP] button to start/stop the Style.

NOTICE

- Do not disconnect the USB flash drive or turn off the instrument while recording. Otherwise, the data may be damaged.

NOTE

- While pressing the [START/STOP] button can start/stop Style playback, it cannot start/stop recording.

- 6 Press the [REC] button to stop recording.

“Writing!” appears in the display, and the performance is saved. When finished saving, “Complete” is shown in the display, and name of the recorded audio file is shown as “AUDIO***” (where “***” is a number).

- 7 To play back the recorded audio file, press the [▶ / ■] (Start/Stop) button.

List of Messages Related to Audio Recording

Message	Description
No USB	No USB flash drive is connected.
Can't Use	Playback is not possible because the USB flash drive cannot be recognized.
Use Adapter	If batteries are used to power the instrument, audio recording is not available. Use an AC adaptor.
File Full	The total number of files on the USB flash drive exceeds the capacity. Delete unnecessary data or use a different USB flash drive.
Unformat	The USB flash drive is unformatted. Format the USB flash drive (page 92).
Protect	The USB flash drive is protected.
Time Up	The recording time exceeds 80 minutes.
Media Full	The USB flash drive has become full.
USB Error	The USB flash drive may have a problem. <ul style="list-style-type: none"> Check if the USB flash drive is included on the Compatible Device List (page 89) on the website. Format the USB flash drive (page 92).

Deleting an Audio File from a USB Flash Drive

A recorded audio file can be deleted.

NOTICE

- Before using a USB flash drive, be sure to read "Precautions for Using the [USB TO DEVICE] Terminal" (page 89).

- 1 Connect a USB flash drive to the [USB TO DEVICE] terminal, and make sure that **USB** is shown (lit continuously) in the upper right of the display.



- 2 While holding down the [SHIFT] button, press the [FUNCTION] button to call up the File Control display.

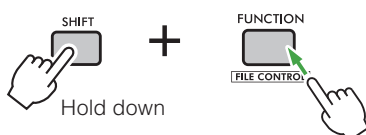

- 3 Rotate the [VOICE] dial until "Delete Audio" (File Control Operation 007) is shown in the upper display line.

The name of an audio file on the USB flash drive is shown in the lower display line as "AUDIO****" (where "****" is a number). Rotate the [STYLE] dial to select the file to be deleted.



- 4 While holding down the [SHIFT] button, press the [+ / YES] button.

"Delete OK?" is shown in the lower display line for confirmation to execute the Delete operation. To cancel the Delete operation, press the [- / NO] button.

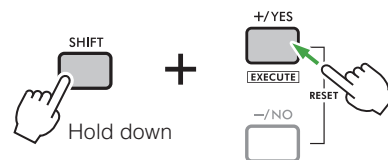

- 5 Press the [+ / YES] button to execute the Delete operation.

"Deleting" appears in the lower display line while the operation is being executed. When the Delete operation is finished, "Complete" is shown in the lower display line.



NOTICE

- The Delete operation cannot be cancelled while it is being executed. Never turn off the instrument or disconnect the USB flash drive during the operation. Otherwise, data may be lost.

- 6 To exit the File Control display, press the [SHIFT] button.

Saving/Recalling Your Favorite Settings (Registration Memory)

The Registration Memory function allows you to save (or “register”) panel settings (such as Voices and Styles) to REGISTRATION MEMORY buttons, then instantly recall custom panel settings with the press of a button. Each of the eight Banks available can comprise settings saved to the four REGISTRATION MEMORY buttons.

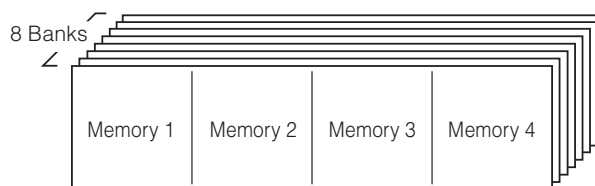

Up to 32 sets of settings (eight banks of four each) can be saved.

A newly purchased instrument comes with sample settings saved in Banks 1 to 8. The saved settings are tailored to the purpose of each bank.

Here, we will look at Bank 1 as an example. Recall settings (Refer to the following.), and while playing the Style, try pressing the black keys.

(Example) Bank 1: Settings for playing by simply pressing black keys while the Style is being played back

Memory	Voices	Style
1	001 Live! Concert Grand Piano	079 Future Trap
2	026 (PSR-E583) / 024 (PSR-E483) Tremolo Smooth Electric Piano	031 Cinematic Pop
3	094 (PSR-E583) / 085 (PSR-E483) S.Art Lite Distortion Guitar	048 80s Power Rock
4	308 (PSR-E583) / 280 (PSR-E483) Funky Lead	017 Boy Band Pop

For details about settings other than Voice and Style, recall the settings from the Bank, and then check the panel buttons and display.

NOTE

- For details on the settings saved in Banks 2 to 8, refer to the Data List on the website.
- You can save your settings to Banks 1 to 8, overwriting the sample settings. For details on saving settings, refer to [page 71](#).

Recalling Settings Saved to Registration Memory

You can recall the sample settings that came with the instrument when it was purchased, or your favorite settings that you had saved yourself.

- 1 Determine the Bank number and Registration Memory number for the settings that you wish to recall.
- 2 Press the [BANK+] button until the Bank number (1 to 8) for the settings that you wish to recall is selected.

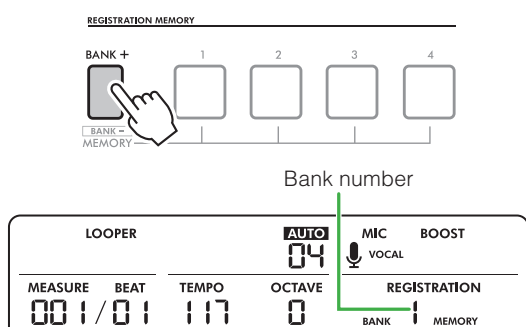

- 3 Press the REGISTRATION MEMORY button ([1] to [4]) for the settings that you wish to recall.

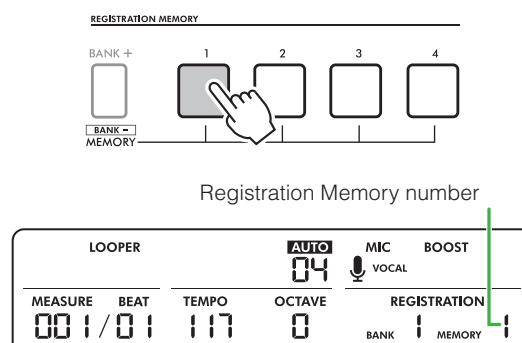

NOTE

- In Song mode ([page 14](#)), settings will not be recalled, even after pressing the button for the Registration Memory number where Style settings are saved. Before recalling settings, press the **MODE SELECT** button to select Style mode.

Saving Panel Settings to Registration Memory

You can save your settings to Banks 1 to 8, overwriting the sample settings.

1 Specify the desired settings, such as Voices and Styles.

NOTE

- Data cannot be saved to Registration Memory during Song playback, in Record Standby mode, or while recording.

2 Press the [BANK+] button until the desired Bank number (1 to 8) is selected.

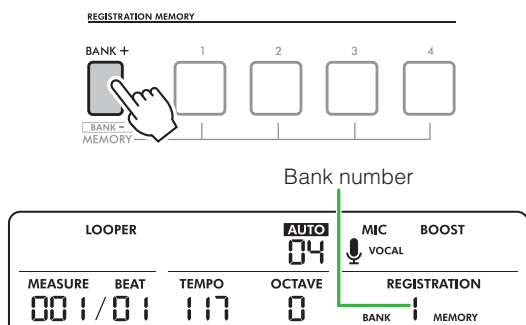

3 While holding down the [BANK+] button, press the desired button ([1] to [4]) to save the settings to Registration Memory.

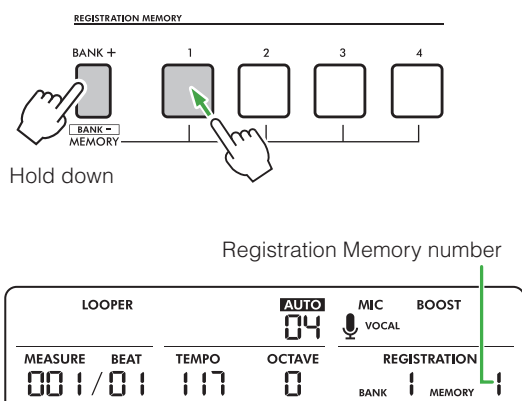

The Registration Memory number in the display flashes. When the settings have been saved, the Registration Memory number in the display stops flashing.

NOTICE

- When data is saved to Registration Memory, the existing data is deleted and overwritten by the new data. In order to prevent data from being accidentally deleted, we recommend making a note of what is saved where.

Parameters with Settings That Can Be Saved to Registration Memory

- **Style settings:** Style number, ACMP on/off, Style volume, Track volume, Track on/off, Main section A/B, Tempo, Fingering Type, Style Key, Auto Chord Play on/off, Auto Chord Play chord progression, Style Revoicing
- **Voices**
 - **Main Voice settings:** Voice number and all settings of the Main Voice Functions (page 105)
 - **Dual Voice settings:** Dual on/off and all settings of the Dual Voice Functions (page 106)
 - **Split Voice settings:** Split on/off and all settings of the Split Voice Functions (page 106)
- **Effect settings:** Reverb Type, Reverb Level, Chorus Type, Motion Effect settings
- **Harmony/Arpeggio settings:** On/off and all settings of the related Functions
- **DSP:** DSP 1/2 on/off, DSP 1/2 type, DSP 2 effect target part, parameter settings of Knobs A/B
- **Other settings:** Transpose, Split Point, Pitch Bend Range, settings of OCTAVE [▲]/[▼] buttons, Scale tuning, Pedal Function, Knob Assign, Sampling Pad Volume, Looper Volume

NOTE

- To restore the contents of the Registration Memory to their default settings at the time of purchase, initialize the instrument by performing the Backup Clear operation (page 114).
- Samples for the Quick Sampling function (page 73) are not saved in the Registration Memory.

Specifying Panel Settings To Be Maintained Across Registration Memory Changes (Freeze)

While Registration Memory allows you to save various settings, there may be some settings that you do not want to recall, depending on the performance situation. For example, you may want to switch between Voice settings and Effect settings without changing the Style. If a Freeze function is used in such cases, pressing a Registration Memory button recalls all settings except, for example, Style-related settings, maintaining (freezing) them so they are not changed.

This instrument has three Freeze functions, corresponding to settings that you may not want to change. Specify the function settings in the Function setting display (page 112).

- 1 Press the [FUNCTION] button to call up the Function setting display.

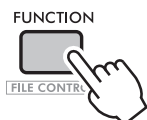

- 2 Rotate the [VOICE] dial until the desired Freeze function setting display is shown.

The default setting is "Off."

- Style Freeze:
Function 074 (PSR-E583)/Function 073 (PSR-E483)
- Transpose Freeze (Trans Freeze):
Function 075 (PSR-E583)/Function 074 (PSR-E483)
- Voice Freeze:
Function 076 (PSR-E583)/Function 075 (PSR-E483)

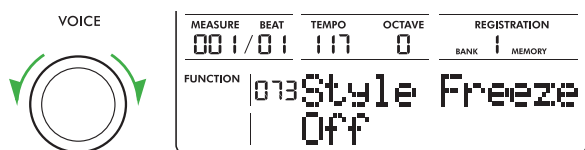

- 3 Rotate the [STYLE] dial to set the Freeze function to "On."

An icon is shown at the right of the display.

Shown when Freeze function is set to "On"

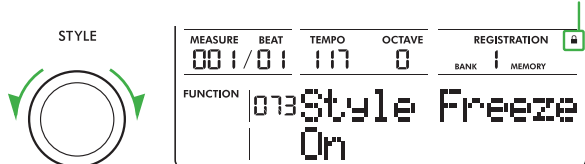

Using the Quick Sampling Function

This instrument features an extremely convenient and powerful Quick Sampling function for sampling audio and playing it back using the pads.

Sampling

Sampling is a technology that lets you record a short portion of a song or a sound, and use the sound (called a “sample”) as part of your performance. Unlike audio files, the samples can be used in various ways: to add special sound effects, or to play in a loop for a repeating rhythmic pattern.

There are three types of audio input that can be sampled.

- Audio from an external device connected to the [AUX IN] jack (page 98)
- Audio from a microphone connected to the [MIC INPUT] jack (page 58)
- Audio from a computer or smart device connected to the [USB TO HOST] terminal (page 102)

WAV files saved on a USB flash drive can also be imported as samples (page 79).

A newly purchased instrument comes with samples (sampled audio) already assigned to the four pads. Let's start by playing back the instrument's samples to get a feel for what they are like.

Playing Back a Sample

- 1 Press a QUICK SAMPLING pad ([A] to [D]) to play back the corresponding sample.

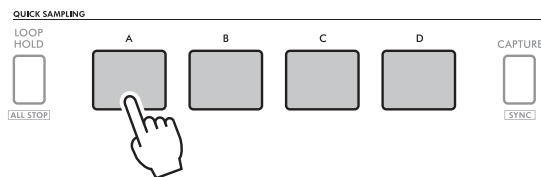

The pad lights up, and the sample is played back as long as the pad is being pressed.

If you continue to press the pad, the sample plays back to the end, then stops. This is called “One-shot playback.”

- 2 Release the QUICK SAMPLING pad.

If the sample is still playing back, the pad light goes off, and sample playback stops.

NOTE

- The volume of the samples assigned to the QUICK SAMPLING pads can be changed in the Function setting display (page 108, Function 047).

Looping a Sample

- 1 While holding down the [LOOP HOLD] button, press a QUICK SAMPLING pad ([A] to [D]) to play back the corresponding sample.

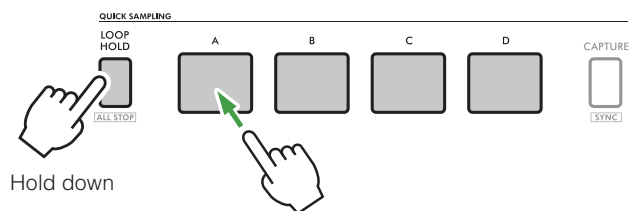

Hold down

Even if you release the pad, it will remain lit, and sample playback will continue.

When the sample reaches the end, playback automatically returns to the beginning and repeats indefinitely. This is called “Loop playback.”

- 2 Press the QUICK SAMPLING pad that is lit.

The pad light goes off, and Loop playback of the sample stops.

NOTE

- Each QUICK SAMPLING pad ([A] to [D]) can be used for One-shot playback or Loop playback.
- All four samples can be played back simultaneously.
- To stop playback of all samples simultaneously, while holding down the [SHIFT] button, press the [LOOP HOLD] button.
- Pad playback uses the tone generator channels for polyphony. For this reason, when playing a large number of notes at the same time, such as with Style or Song playback, the sound may occasionally be muted during Loop playback, even though the pad was lit. In such a case, press the pad once so that its light goes off, and then repeat step 1 to start Loop playback again. If the condition persists, try to reduce the number of notes played at the same time.

Playing Back Samples in Sync with Style/Song Playback (Sampling Sync Playback)

You can play back samples in sync with Style/Song playback.

- 1 While holding down the [SHIFT] button, press the [CAPTURE] button to call up the Sampling Sync Playback setting display.

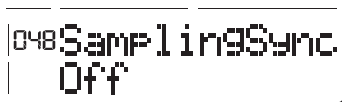
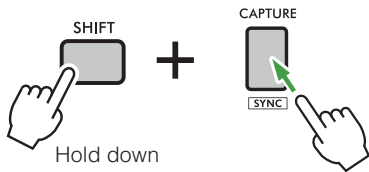

- 2 Rotate the [STYLE] dial to set Sampling Sync Playback to "On."



- 3 Perform the following steps depending on when you want the sample to play back.

Playing Back in Sync with Measure Changes During Style/Song playback

- 3-1 Start playback of the desired Style or Song (page 34, 53).
- 3-2 Slightly before the point where you wish to start sample playback, while holding down the [LOOP HOLD] button, press the QUICK SAMPLING pad for the desired sample.
The sample starts playing from the beginning of the measure immediately after you pressed the pad.

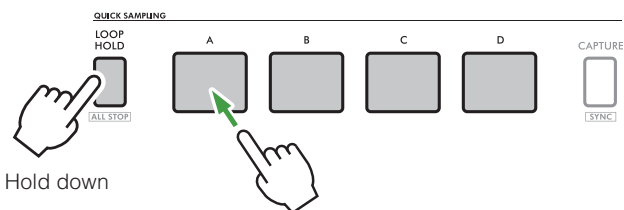

Playing Back When Style/Song Playback Begins

- 3-1 While holding down the [LOOP HOLD] button, press the QUICK SAMPLING pad for the desired sample.

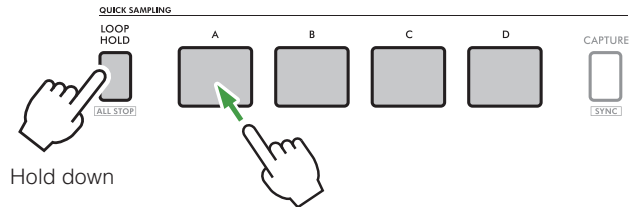

- 3-2 Start playback of the desired Style or Song (page 34, 53).
The sample starts playing when Style/Song playback begins.

- 4 Press the [SHIFT] button to return to the home display (page 14).

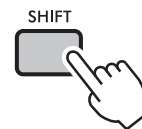

Getting Ready for Sampling

Connect an external device for sampling, and adjust the volume level for recording.

NOTE

- If the volume of the audio input is too low, the instrument cannot sample the sound.

- 1 Turn the **[MASTER VOLUME]** control fully counterclockwise, to “MIN.”

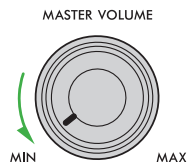

- 2 Connect an external device for sampling.

For details about how to connect external devices, refer to the following pages.

- **[AUX IN] jack:** [page 98](#)
- **[MIC INPUT] jack:** [page 58](#)
- **[USB TO HOST] terminal:** [page 102](#)

- 3 Make sure that the volume of the audio input is set high enough.

- **[AUX IN] jack**
Set the volume of the external device to maximum.
- **[MIC INPUT] jack**
Set the **[GAIN]** knob on the rear panel to its highest setting.
- **[USB TO HOST] terminal**
On the computer or smart device, set the playback volume for the MIDI file or audio file to maximum.

NOTE

- If the playback volume is still low even though the volume of the external device connected to the **[AUX IN]** jack is set to maximum, you can adjust the volume by increasing it in the Function setting display ([page 111, Function 069](#) (PSR-E583)/[Function 068](#) (PSR-E483)). However, increasing the volume to more than 50 may cause the sound to become distorted.
- If the audio input is still low even though the playback volume on the computer or smart device is set to maximum, you can adjust the volume by increasing it in the Function setting display ([page 111, Function 070](#) (PSR-E583)/[Function 069](#) (PSR-E483)).

- 4 Turn the **[MASTER VOLUME]** control to adjust the volume of the instrument speakers.

NOTE

- The volume of the speakers has no effect on sampling results.

Sampling External Audio

You can sample audio input, and assign it to a QUICK SAMPLING pad (**[A]** to **[D]**).

NOTE

- The sampling rate is 44.1 kHz, 16-bit, stereo.
- The samples can also be saved onto a USB flash drive ([page 78](#)).

- 1 Get ready for sampling.

Prepare for audio input. For details, refer to “Getting Ready for Sampling.”

NOTICE

- The sampling operation overwrites previously existing samples. To keep important data, save it onto a USB flash drive ([page 78](#)).

NOTE

- If you wish to use the Melody Suppressor function ([page 99](#)) when sampling, be sure to set it before entering Quick Sampling mode.
- If you wish to automatically cut the silent sections at the beginning and end of sampling, select “On” in the Function setting display ([page 108, Function 046](#)).

- 2 Press the **[CAPTURE]** button to enter Quick Sampling mode.

“Sampling” is shown in the upper display line, and “Press A-D” is shown in the lower display line.

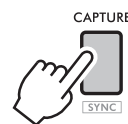

Sampling
Press A-D

To cancel sampling, exit Quick Sampling mode by pressing the **[CAPTURE]** button again.

- 3 Press the QUICK SAMPLING pad where the sample is to be assigned to enter the Record Standby mode.

The pad flashes, and “Start?” is shown in the lower display line.

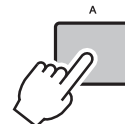

Sampling
Start?

NOTE

- To switch to a different pad, press a different pad.
- To exit Record Standby mode, press the **[CAPTURE]** button again.

4 Pause playback on the external device at the beginning of the sound or phrase that you wish to sample, or prepare to record the sound with the microphone.

5 Press the pad that is flashing to start sampling.
 “REC” appears to the left of the lower display line.



NOTICE

- Do not disconnect the USB flash drive during the sampling operation. Otherwise, the operation of the instrument may become unstable, and sampling may not be performed properly.

NOTE

- You can also press the [+ / YES] button to start sampling.

6 Start playback on the external device, or input sound to the microphone.

NOTE

- If the input volume from the external device or microphone is too low, “Low Input” appears in the display and sampling is cancelled. Then, the instrument returns to Record Standby mode, as described in step 3.

7 Stop audio input at the end of the sound or phrase that you are sampling.

If you are using an external device, stop playback. If you are using a microphone, stop inputting sound to it.

8 Press the lit pad again to stop sampling.

“Writing!” appears briefly in the upper display line, and the sample is saved. The pad light goes off, sampling ends, and the instrument returns to the status described in step 2.

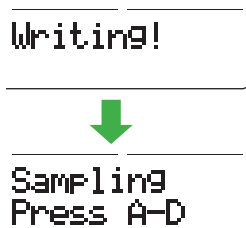

NOTE

- Sampling time is limited to a maximum of 9.6 seconds. When the time limit is reached, sampling stops automatically, and the recorded sample (up to that point) is stored to the instrument.

9 Press the [CAPTURE] button to exit Quick Sampling mode.

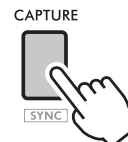

10 Press the QUICK SAMPLING pad to play back the sample.

To sample during audio playback

Once you are familiar with the sampling operation, try streamlining the operation by starting and stopping sampling while the sound of the external device is playing back.

1. Perform steps 2 to 3 of “Sampling External Audio” (page 75).
2. Stop playback on the external device a few measures before the sound or phrase that you wish to sample.
3. Start playback on the external device.
4. Press the pad that is flashing at the point where you wish to start sampling.
5. When you wish to stop sampling, press the pad again.
6. Stop playback on the external device, and then check what you have just sampled.

NOTE

- If there is silence that you wish to keep in the sample, but is cut automatically, select “Off” in the Function setting display (page 108, Function 046).

Video Manuals About Quick Sampling

These show how to sample from a smart device.

<https://manual.yamaha.com/mi/rt/psr-e483/videos/w/sampling/>

Restoring the Default Samples

This operation lets you restore the default samples to each QUICK SAMPLING pad. However, keep in mind that this deletes the samples that you have assigned to the pads.

NOTICE

- Restoring the default samples overwrites any samples that have been assigned to the pads. To keep important samples, save them onto a USB flash drive (page 78) before restoring the default samples.

1 Press the [CAPTURE] button to enter Quick Sampling mode.

“Sampling” is shown in the upper display line, and “Press A-D” is shown in the lower display line.



2 While holding down the [CLEAR] button, press the QUICK SAMPLING pad for the sample that you wish to delete.

The pad flashes, and “Clear Smp1?” is shown in the lower display line.

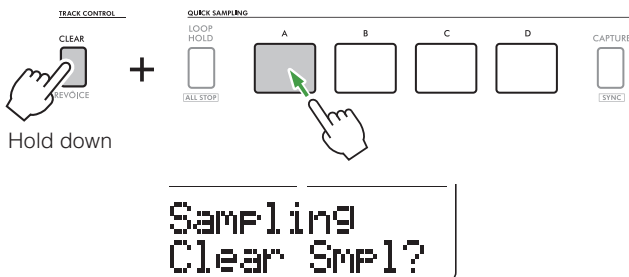

3 Press the [+ / YES] button.

The QUICK SAMPLING pad lights up, and “Sure? YES/NO” is shown in the lower display line.

To cancel the operation, press the [- / NO] button. If the operation is cancelled, the QUICK SAMPLING pad light goes off, and the instrument returns to the status described in step 2.



4 Press the [+ / YES] button again.

“Writing!” appears in the upper display line. The QUICK SAMPLING pad light goes off, and the default sample is restored.

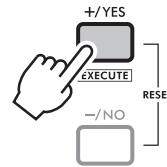

5 Press the [CAPTURE] button to exit Quick Sampling mode.

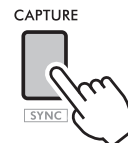

Saving a Sample onto USB Flash Drive

Samples that are assigned to QUICK SAMPLING pads ([A] to [D]) can individually be saved onto a USB flash drive as sample files.

Sample files that have been saved onto a USB flash drive can be imported and re-assigned to the pads.

NOTE

- If the instrument is in Quick Sampling mode, press the [CAPTURE] button to exit the mode, and then follow the steps below.

- 1 Connect a USB flash drive to the [USB TO DEVICE] terminal (page 12).
- 2 Press the QUICK SAMPLING pads ([A] to [D]) to determine which pad is assigned the sample that you wish to save.

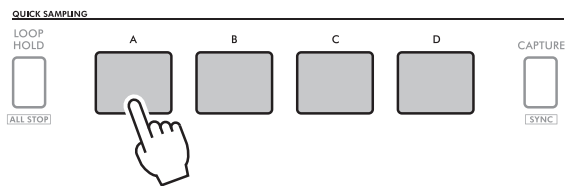

- 3 While holding down the [SHIFT] button, press the [FUNCTION] button to call up the File Control display.

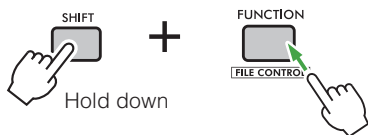

- 4 Rotate the [VOICE] dial until "Save Smpl" (File Control Operation 011) is shown in the upper display line.

"Press A-D" is shown in the lower display line.



- 5 Press the QUICK SAMPLING pad assigned the sample that you wish to save.

The pressed pad flashes. If you pressed a pad that is not assigned a sample, "No Data" is shown in the display. In that case, select a different pad.

- 6 Rotate the [STYLE] dial to select the file to be saved.

- SMPL001 to SMPL250

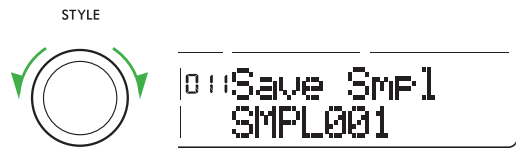

- 7 While holding down the [SHIFT] button, press the [+ / YES] button ([EXECUTE]) to confirm the selected file.

"Save OK?" is shown in the lower display line. To return to step 4 without saving, press the [- / NO] button.

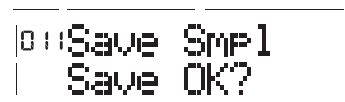
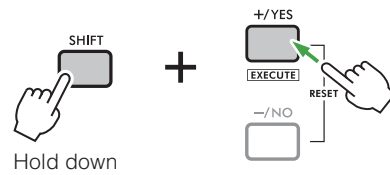

Overwriting Existing Files

If data had already been saved to the selected file, "Overwrite?" is shown in the lower display line.

- 8 Press the [+ / YES] button.

"Saving" appears briefly in the lower display line, and the sample is saved.



- 9 Press the [SHIFT] button to exit the File Control display.



Importing WAV File from USB Flash Drive as a Sample

You can import WAV files stored on a USB flash drive into the internal memory as samples, and assign them to QUICK SAMPLING pads.

NOTE

- Only PCM files in the WAV format (44.1 kHz, 16-bit, monaural or stereo) can be imported.

NOTICE

- The importing operation overwrites previously existing samples. To keep important data, save it first (page 78).

1 If the instrument is in Quick Sampling mode, press the [CAPTURE] button to exit the mode, and then follow the steps below.

2 Connect a USB flash drive to the [USB TO DEVICE] terminal (page 12).

3 While holding down the [SHIFT] button, press the [FUNCTION] button to call up the File Control display.

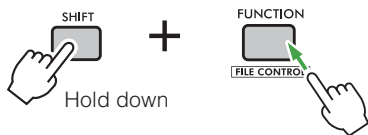

4 Rotate the [VOICE] dial until “Import WAV” (File Control Operation 014) is shown in the upper display line.

“Press A-D” is shown in the lower display line. If there are no WAV files on the USB flash drive, “No File” is shown instead.



5 Press the QUICK SAMPLING pad to be assigned.

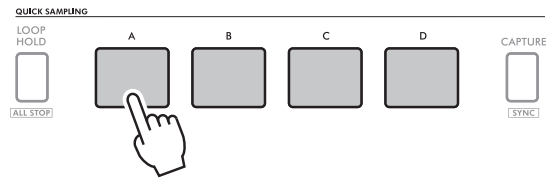

6 Rotate the [STYLE] dial to select the desired file.



7 While holding down the [SHIFT] button, press the [+ / YES] button ([EXECUTE]) to confirm the selected file.

“Import OK?” is shown in the lower display line. To return to step 4 without importing, press the [- / NO] button.

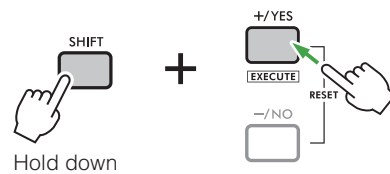

8 Press the [+ / YES] button.

“Importing” appears briefly in the lower display line, and the WAV file is assigned to the pad as a sample.

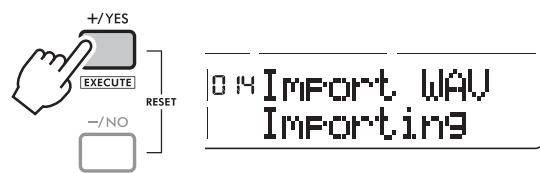

9 Press the [SHIFT] button to exit the File Control display.



10 Try playing the imported sample.

To play back the sample, press the pad to which the loaded sample was assigned.

Loading a Sample from USB Flash Drive

You can load samples stored on a USB flash drive into the internal memory, and assign them to QUICK SAMPLING pads.

1 If the instrument is in Quick Sampling mode, press the [CAPTURE] button to exit the mode, and then follow the steps below.

2 Connect a USB flash drive to the [USB TO DEVICE] terminal (page 12).

3 While holding down the [SHIFT] button, press the [FUNCTION] button to call up the File Control display.

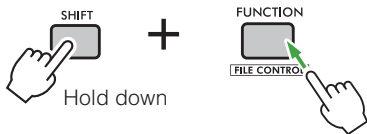

4 Rotate the [VOICE] dial until “Load Smpl” (File Control Operation 012) is shown in the upper display line.

“Press A-D” is shown in the lower display line. If there are no samples on the USB flash drive, “No File” is shown instead.



5 Press the QUICK SAMPLING pad to be assigned.

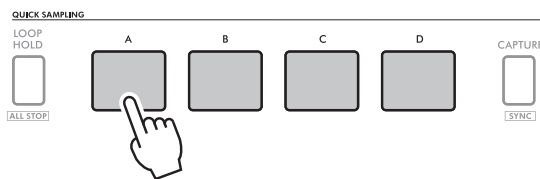

6 Rotate the [STYLE] dial to select the desired file.



7 While holding down the [SHIFT] button, press the [+ / YES] button ([EXECUTE]) to confirm the selected file.

“Load OK?” is shown in the lower display line. To return to step 4 without loading, press the [- / NO] button.

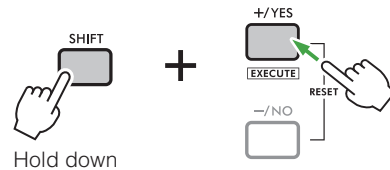

8 Press the [+ / YES] button.

“Loading” appears briefly in the lower display line, and the sample is assigned to the pad.

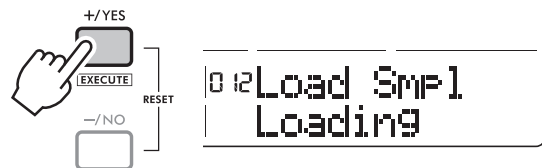

9 Press the [SHIFT] button to exit the File Control display.

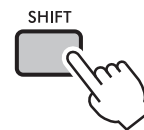

10 Try playing the loaded sample.

To play back the sample, press the pad to which the loaded sample was assigned.

Deleting a Sample From USB Flash Drive

- 1 If the instrument is in Quick Sampling mode, press the [CAPTURE] button to exit the mode, and then follow the steps below.
- 2 Connect a USB flash drive to the [USB TO DEVICE] terminal (page 12).
- 3 While holding down the [SHIFT] button, press the [FUNCTION] button to call up the File Control display.

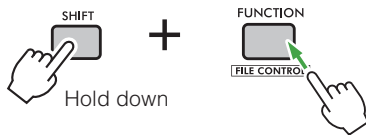

- 4 Rotate the [VOICE] dial until “Delete Smpl” (File Control Operation 013) is shown in the upper display line.

The file name of a sample saved on the USB flash drive is shown in the lower display line. If there are no saved samples, “No File” is shown instead.

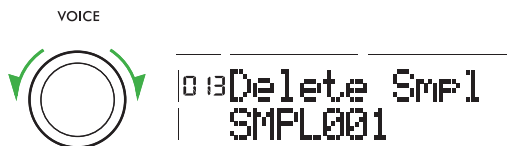

- 5 Rotate the [STYLE] dial to select the file to be deleted.



- 6 While holding down the [SHIFT] button, press the [+ / YES] button ([EXECUTE]) to confirm the selected file.

“Delete OK?” is shown in the lower display line. To return to step 4 without deleting, press the [- / NO] button.

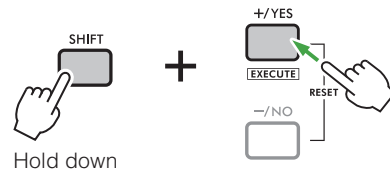

- 7 Press the [+ / YES] button.

“Deleting” appears briefly in the lower display line, and the sample is deleted.



- 8 Press the [SHIFT] button to exit the File Control display.



Using the Looper Function

The Looper function allows you to record a phrase, then repeatedly play it back in a loop. For example, you can record an impressive part of the song that you wish to play and loop it in accordance with the Style, allowing you to enjoy a performance that is closer to the original song.

Video Manuals About Looper Function These show examples of performances using phrase recording and looping.
<https://manual.yamaha.com/mi/rt/psr-e483/videos/w/looper/>

Recording a Phrase

- 1 **Specify the tempo of the phrase that you wish to play (page 16) and select a Voice (page 20).**
- 2 **While holding down the [REC] button, press the [LOOPER] button to enter Record Standby mode.** “Looper” is shown in the upper display line.



Number of measures to record Quantization value

- 3 **If necessary, rotate the [STYLE] dial to select the number of measures to be recorded.**

The number of measures that can be set varies depending on the currently selected time signature. A maximum length of 32 quarter notes can be set.

Examples:

- When time signature 4/4 is set:
From 1 to 8 measures can be set
- When time signature 1/4 is set:
From 1 to 32 measures can be set
- When time signature 16/2 is set:
Only 1 measure can be set



- 4 **If necessary, rotate the [VOICE] dial to select the quantization value.**



Quantization is a function that corrects discrepancies

in recording timing. Even if you think you are playing accurately, the timing may be slightly too early or too late. Selecting the shortest note in the performance being recorded ensures accurate correction.

If you wish to record the performance as is, select “Off.”

This instrument allows you to select from the following seven settings.

Q:Off	No quantization setting
Q:32	Thirty-second note
Q:16	Sixteenth note
Q:8	Eighth note
Q:32T	Thirty-second note triplet
Q:16T	Sixteenth note triplet
Q:8T	Eighth note triplet

- 5 **Press the [START/STOP] button or any key in the keyboard to start recording.**

Once the metronome has started, play along with it. The metronome will not be recorded.

The Voice name is shown in the upper display line, and “Recording” is shown in the lower display line.



When the number of measures specified in step 3 has been recorded, Loop playback of the recorded phrase starts.

Re-recording (Looper Undo)

If Loop playback of the recorded phrase is different from what you expected, you can re-record it.

By default, pressing the [◀◀] button during Loop playback erases the last recorded sound. Each press of the [◀◀] erases one sound at a time from the end of the phrase. To restore the erased sound, press the [▶▶] button.

You can change the method of re-recording in the Function setting display (page 107, Function 036).



6 To stop recording, press the [START/STOP] or [REC] button.

“Writing!” appears in the upper display line.



If a phrase has already been recorded, “Save Looper” is shown in the upper display line, and “Sure? YES/NO” is shown in the lower display line for confirmation to overwrite the existing recording.



• To overwrite

Press the [+ / YES] button.

“Writing!” appears briefly in the upper display line, and the recording is overwritten.

• To not overwrite

Press the [- / NO] button.

The home display (page 14) is called up.

To save both the previously recorded phrase and the newly recorded phrase, save the previously recorded phrase onto a USB flash drive before overwriting it. For details on saving onto a USB flash drive, refer to page 86.

Overdubbing

You can record a new performance on top of a previously recorded phrase. This recording technique is called “overdubbing.”

Although you can also overdub the looped phrase in step 5 on page 82, here, we will record over a previously saved phrase.

NOTE

- Changing the Voice or tempo during overdubbing also changes the Voice or tempo of the previously recorded phrase. If you do not wish for the Voice or tempo to be changed, record the subsequent phrase using the same Voice and tempo as those of the recorded phrase.

- 1 Select the same Voice as that of the phrase that you wish to be overdubbed (page 20).
- 2 While holding down the [REC] button, press the [LOOPER] button to enter Record Standby mode.



- 3 Press the [START/STOP] button or any key in the keyboard to play back the saved phrase.

During overdubbing, the metronome does not start. Play along with the saved phrase.

The Voice name is shown in the upper display line, and “Recording” is shown in the lower display line.



- 4 To stop recording, press the [START/STOP] or [REC] button.

“Save Looper” is shown in the upper display line, and “Sure? YES/NO” is shown in the lower display line for confirmation to overwrite the existing recording.

• To overwrite

Press the [+ / YES] button.

“Writing!” appears briefly in the upper display line, and the recording is overwritten.

• To not overwrite

Press the [- / NO] button.

The home display (page 14) is called up.

Loop Playback of a Recorded Phrase

- 1 Press the [LOOPER] button to start Loop playback.

During playback, **LOOPER** flashes in the upper display line.

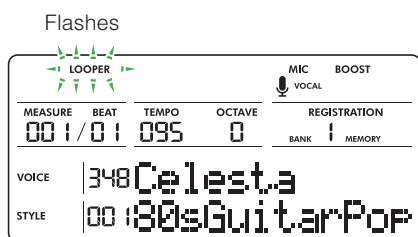
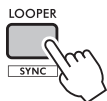

NOTE

- After recording using the Looper function, changing the Style or Song, or turning the instrument off, then on again may cause the recording and tempo to change. If the playback sounds different from the original recording, check the tempo (page 16).

- 2 Press the [LOOPER] button again to stop Loop playback.

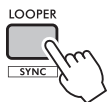

Loop Playback of a Phrase in Sync with Style/Song Playback (Sync Playback)

You can start Loop playback in sync with the start of Style or Song playback.

- 1 Select the Style or Song that you wish to play along with the looped phrase (page 13).
- 2 While holding down the [SHIFT] button, press the [LOOPER] button.
The instrument enters Sync Playback Standby mode, and **LOOPER** flashes in the upper display line.



- 3 Press the [START/STOP] button to start playback of the Style/Song selected in step 1.

Loop playback of the recorded phrase starts when Style/Song playback begins.



Adjusting the Volume of the Loop Playback Phrase

You can adjust the volume balance between the Loop playback phrase and Style/Song playback. Adjust the setting in the Function setting display (page 107, Function 037).

Deleting a Recorded Phrase

While holding down the [CLEAR] button, press the [LOOPER] button.

“Clear Looper” is shown in the upper display line, and “Sure? YES/NO” is shown in the lower display line for confirmation to delete.

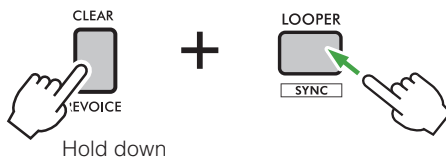

```

Clear Looper
Sure? YES/NO
  
```

- **To delete**

Press the [+ / YES] button.

“Writing!” appears in the upper display line, and the recording is deleted.

- **To not delete**

Press the [- / NO] button.

The home display ([page 14](#)) is called up.

Saving a Phrase Recorded Using Looper Function onto USB flash drive

Phrases recorded using the Looper function can be saved onto a USB flash drive. In addition, saved Looper files can be imported and played back. For details on loading saved Looper files, refer to [page 87](#).

- 1 Connect a USB flash drive to the [USB TO DEVICE] terminal, and make sure that **USB** is shown (lit continuously) in the upper right of the display.



- 2 While holding down the [SHIFT] button, press the [FUNCTION] button to call up the File Control display.

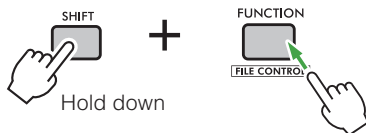

- 3 Rotate the [VOICE] dial until "Save Looper" (File Control Operation 008) is shown in the upper display line.

An available name for the Looper file to be saved is shown in the lower display line as "LOP***" (where "****" is a number between 001 and 100). To select a different file name, rotate the [STYLE] dial to select from LOP001 to 100.



- 4 While holding down the [SHIFT] button, press the [+ / YES] button.

"Save OK?" is shown in the lower display line for confirmation to execute the Save operation. To cancel the Save operation, press the [- / NO] button.

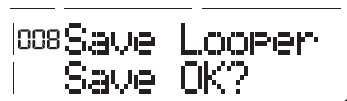
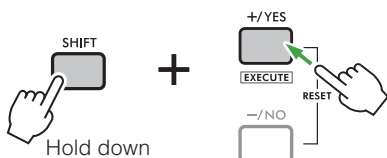

Overwriting Existing Files

If data had already been saved to the selected file, "Overwrite?" is shown in the lower display line.

- 5 Press the [+ / YES] button again to execute the Save operation.

"Saving" appears in the lower display line while the operation is being executed. After a while, a message indicating completion of the operation appears, and a Looper file is saved to a "USER FILES" folder that was automatically created on the USB flash drive.

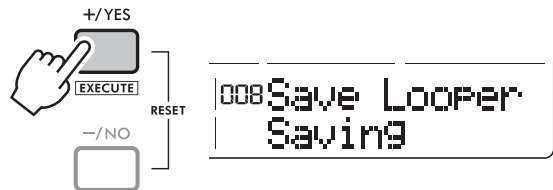

When the Save operation is finished, "Complete" is shown in the lower display line. The "USER FILES" folder is automatically created on the USB flash drive.

NOTICE

- The Save operation cannot be cancelled while it is being executed. Never turn off the instrument or disconnect the USB flash drive during the operation. Otherwise, data may be lost.

NOTE

- The amount of time required for this operation may vary depending on the condition of the USB flash drive.

- 6 To exit the File Control display, press the [SHIFT] button.

Loading a Looper File from USB Flash Drive

You can load Looper files stored on a USB flash drive into the internal memory, and play them back.

- 1 Connect a USB flash drive to the [USB TO DEVICE] terminal, and make sure that **USB** is shown (lit continuously) in the upper right of the display.



- 2 While holding down the [SHIFT] button, press the [FUNCTION] button to call up the File Control display.

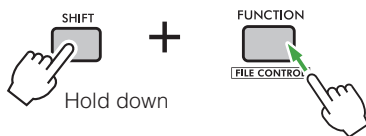

- 3 Rotate the [VOICE] dial until "Load Looper" (File Control Operation 009) is shown in the upper display line.

The name of a Looper file on the USB flash drive is shown in the lower display line as "LOP***" (where "***" is a number between 001 and 100). If there are no Looper files on the USB flash drive, "No File" is shown instead.



- 4 Rotate the [STYLE] dial to select the desired file.



- 5 While holding down the [SHIFT] button, press the [+ / YES] button to confirm the selected file.

"Load OK?" is shown in the lower display line. To return to step 3 without completing the operation, press the [- / NO] button.

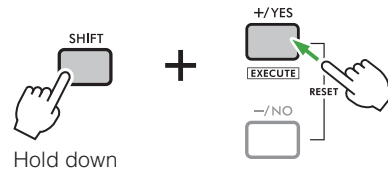

- 6 Press the [+ / YES] button.

"Loading" appears briefly in the lower display line, and the sample is assigned to the pad.



When the Load operation is finished, "Complete" is shown in the lower display line.

- 7 To exit the File Control display, press the [SHIFT] button.

- 8 Play back the loaded Looper file ([page 84](#)).

Deleting a Looper File from USB Flash Drive

Looper files on a USB flash drive can be deleted.

- 1 Connect a USB flash drive to the [USB TO DEVICE] terminal, and make sure that **USB** is shown (lit continuously) in the upper right of the display.



- 2 While holding down the [SHIFT] button, press the [FUNCTION] button to call up the File Control display.

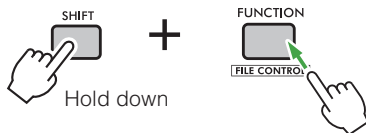

- 3 Rotate the [VOICE] dial until “Delete Looper” (File Control Operation 010) is shown in the upper display line.

The name of a Looper file on the USB flash drive is shown in the lower display line as “LOP***” (where “***” is a number between 001 and 100). If there are no Looper files on the USB flash drive, “No File” is shown instead. If necessary, rotate the [STYLE] dial to select the file to be deleted.



- 4 While holding down the [SHIFT] button, press the [+ / YES] button.

“Delete OK?” is shown in the lower display line for confirmation to execute the Delete operation. To cancel the Delete operation, press the [- / NO] button.

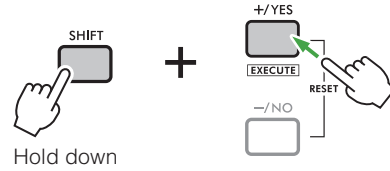

- 5 Press the [+ / YES] button to execute the Delete operation.

“Deleting” appears in the lower display line while the operation is being executed.



When the Delete operation is finished, “Complete” is shown in the lower display line.

NOTICE

- The Delete operation cannot be cancelled while it is being executed. Never turn off the instrument or disconnect the USB flash drive during the operation. Otherwise, data may be lost.

- 6 To exit the File Control display, press the [SHIFT] button.

Connecting a USB Flash Drive

Connecting a USB flash drive (sold separately) to the [USB TO DEVICE] terminal allows you to save data created on the instrument, such as User Songs and parameter settings. The saved data can be recalled to the instrument for future use.

Z

NOTICE

- When performing USB flash drive operations, be sure to use an AC adaptor. Battery power may not last through these crucial operations. When using certain functions, “Use Adapter” may appear, and the selected function cannot be used unless an AC adaptor is connected.

NOTE

- To play back data stored on a USB flash drive, refer to “Playing Back a Song (MIDI Data)” (page 52) and “Playing Back an Audio File from a USB Flash Drive” (page 54).

Precautions for Using the [USB TO DEVICE] Terminal

This instrument features a built-in [USB TO DEVICE] terminal. When connecting a USB device to the [USB TO DEVICE] terminal, be sure to observe the following.

NOTE

- For more information about the handling of USB devices, refer to the owner's manual of the USB device.

Compatible USB Devices

USB flash drives

Other USB devices such as a USB hub, computer keyboard or mouse cannot be used. Compatible USB devices are listed under “Documents & Data” on the following website. Be sure to check this website before purchasing devices.

<https://manual.yamaha.com/mi/rt/psr-e483/downloads/>

Although USB 1.1 to 3.0 devices can be used with this instrument, the time required to save data to or load data from the device will vary depending on the type of data and the state of this instrument.

NOTICE

- The [USB TO DEVICE] terminal is rated for maximum 5 V/500 mA. Do not connect a USB device that exceeds this rating, otherwise this instrument may become damaged.

Connecting a USB Device

Insert a plug that matches the shape of the [USB TO DEVICE] terminal, paying careful attention to its orientation.

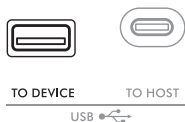

NOTICE

- Avoid connecting or disconnecting a USB device during playback, recording and file management operations (such as saving, copying, deleting, and formatting), and when accessing the USB device. Otherwise, this instrument may stop functioning or the USB device and the data may become damaged.
- Wait a few seconds between connecting and disconnecting a USB device (in either order).
- Do not use a cable to connect a USB flash drive.

Using a USB Flash Drive

You can save data that you have created onto as well as play back data from a USB flash drive connected to the instrument.

Number of USB Flash Drives That Can Be Used

Only one USB flash drive at a time can be connected to the [USB TO DEVICE] terminal.

Formatting a USB Flash Drive

The USB flash drive should only be formatted using this instrument (page 92). A USB flash drive formatted on another device may not operate properly.

NOTICE

- The Format operation overwrites any previously existing data. Make sure that the USB flash drive to be formatted does not contain important data.

Protecting Your Data (Write-Protect)

Some USB flash drives have a write-protect function to prevent accidental erasure of data. To prevent important data from being inadvertently erased, apply the write-protect provided with each USB flash drive. Before saving data onto the USB flash drive, make sure to disable write-protect.

Turning Off the Instrument with a USB Flash Drive Connected

Before turning off the instrument, make sure that it is NOT accessing the USB flash drive during playback, recording and file management operations (such as saving, copying, deleting, and formatting). Otherwise, the data or USB flash drive may become damaged.

File Operations Related to USB Flash Drives

NOTICE

- Before using a USB flash drive, be sure to read “Precautions for Using the [USB TO DEVICE] Terminal” (page 89).

- 1 Connect a USB flash drive to the [USB TO DEVICE] terminal, and make sure that **USB** is shown (lit continuously) in the upper right of the display.



- 2 While holding down the [SHIFT] button, press the [FUNCTION] button to call up the File Control display.

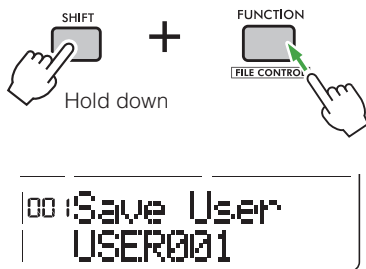

If “UnFormat” followed by “Format OK?” is shown:

This indicates that the connected USB flash drive requires formatting. Execute the Format operation by following the instructions starting with step 2 on page 92.

NOTE

- The File Control display cannot be called up in the following situations.
 - During playback and recording of Styles or Songs
 - While in Quick Sampling mode or Audio mode
 - If “USB” is not shown even after you have connected a USB flash drive to the [USB TO DEVICE] terminal
- No sound will be produced if the keyboard is played while the File Control display is shown. Only buttons related to File Control operations will be active.

- 3 Rotate the [VOICE] dial to select an operation.

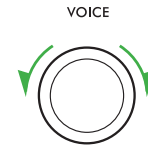

If necessary, rotate the [STYLE] dial to select the data. For details, refer to the description on the reference page indicated in the “List of File Control Operations” below.

List of File Control Operations

	Display	File Control function	Reference (page)
001	Save User	Saving User data onto a USB flash drive	93
002	Load User	Loading a User file from a USB flash drive	94
003	Delete User	Deleting a User file from a USB flash drive	95
004	Load Style	Loading a Style file from a USB flash drive	46
005	Save SMF	Saving a User Song as a MIDI file onto a USB flash drive	66
006	Delete SMF	Deleting a MIDI file from a USB flash drive	67
007	Delete Audio	Deleting an audio file from a USB flash drive	69
008	Save Looper	Saving Looper data onto a USB flash drive	86
009	Load Looper	Loading a Looper file from a USB flash drive	87
010	DeleteLooper	Deleting a Looper file from USB flash drive	88
011	Save Smpl	Saving a sample onto a USB flash drive	78
012	Load Smpl	Loading a sample from a USB flash drive	80
013	Delete Smpl	Deleting a sample from a USB flash drive	81
014	Import WAV	Importing a WAV file from a USB flash drive as a sample	79
015	Format	Formatting a USB flash drive	92

4 While holding down the [SHIFT] button, press the [+ / YES] to perform the operation ([EXECUTE]).

Depending on the selected operation, it may be necessary to hold down the [SHIFT] button and press the [+ / YES] button again to perform the operation.

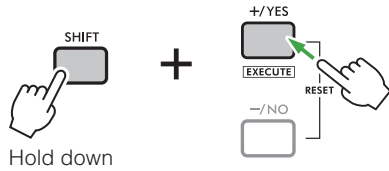

5 If the confirmation message “Save OK?” or “Load OK?” is shown, press the [+ / YES] button.

To cancel the operation, press the [- / NO] button.

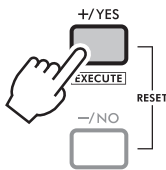

6 To exit the File Control display, press the [SHIFT] button.



NOTE

- You can also press one of the following buttons to exit the File Control display.
 - [FUNCTION] button
 - [PORTABLE GRAND] button

Characters That Can Be Used in File Names

Only single-byte alphanumeric characters can be used in file names for User Songs, etc. Files with names that contain Japanese kanji or kana will not be recognized. However, if “Language” (page 113, Function 081 (PSR-E583)/Function 080 (PSR-E483) in the Function setting display is set to “Japanese,” file names containing Japanese single-byte katakana characters will be shown correctly in the display.

Valid File Locations on a USB Flash Drive

If you use a computer, etc., to manage the files on the USB flash drive, be sure to store the files either in the USB flash drive’s root directory or a first-level or second-level folder in the root directory. Files stored in third-level folders cannot be selected and played by the instrument.

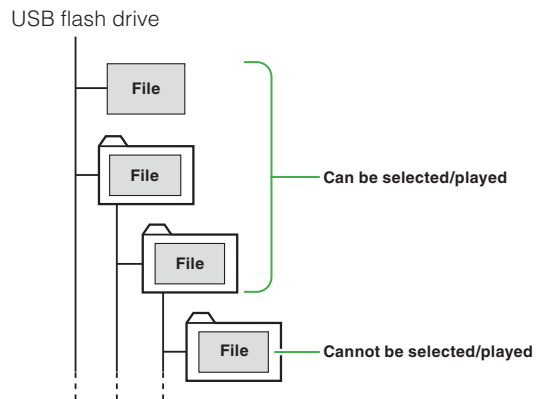

NOTE

- If there is a large amount of data on the USB flash drive, it might take some time to read the files.

Formatting a USB Flash Drive

The Format operation allows you to prepare commercially available USB flash drives for use with the instrument.

NOTICE

- The Format operation overwrites any previously existing data. Make sure that the USB flash drive to be formatted does not contain important data.

1 Connect a USB flash drive to the [USB TO DEVICE] terminal, and make sure that **USB** is shown (lit continuously) in the upper right of the display.



2 While holding down the [SHIFT] button, press the [FUNCTION] button to call up the File Control display.

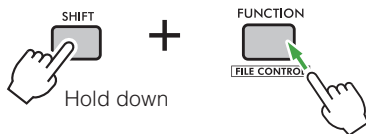

3 Rotate the [VOICE] dial until "Format" (File Control Operation 015) is shown in the upper display line.

"Format OK?" is shown in the lower display line.



4 While holding down the [SHIFT] button, press the [+ / YES] button.

"Sure? YES/NO" is shown in the lower display line for confirmation to execute the Format operation. To cancel the Format operation, press the [- / NO] button.

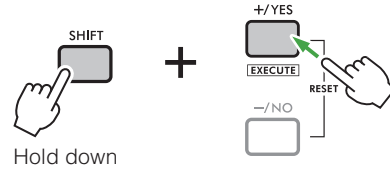

5 Press the [+ / YES] button to format the USB flash drive.

"Formatting" appears in the lower display line while the operation is being executed.

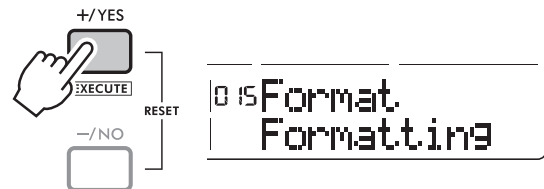

When the Format operation is finished, "Complete" is shown in the lower display line. After the "USER FILES" folder is automatically created on the USB flash drive, the instrument returns to step 3.

NOTICE

- The Format operation cannot be cancelled while it is being executed. Never turn off the instrument or disconnect the USB flash drive during the operation. Otherwise, data may be lost.

6 To exit the File Control display, press the [SHIFT] button.

Saving User Data to USB Flash Drive

The following five types of data on this instrument are called "User data."

- All 10 User Songs (page 61)
- Style data transferred from a computer and loaded to Styles 346 to 355 (page 46)
- Auto Chord Play User chord progression data (page 39)
- All Registration Memory settings (page 71)
- Looper data (page 82)

The User data can be saved as a single "User File" (.usr) onto a USB flash drive.

NOTE

- User Song data can be individually saved as MIDI files onto a USB flash drive (page 66).
- For details on saving samples, refer to page 78.
- The extension (.usr) of the User File is not shown in the display of this instrument. Confirm the extension on the computer display when connecting the USB flash drive to a computer.

- 1 Connect a USB flash drive to the [USB TO DEVICE] terminal, and make sure that **USB :** is shown (lit continuously) in the upper right of the display.



- 2 While holding down the [SHIFT] button, press the [FUNCTION] button to call up the File Control display.

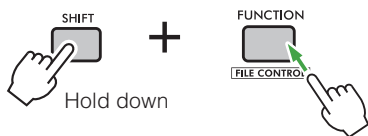

- 3 Rotate the [VOICE] dial until "Save User" (File Control Operation 001) is shown in the upper display line.

An available name for the User file to be saved is shown in the lower display line as "USER***" (where "****" is a number between 001 and 100). To select a different file name, rotate the [STYLE] dial to select from USER001 to 100.



- 4 While holding down the [SHIFT] button, press the [+ / YES] button.

"Save OK?" is shown in the lower display line for confirmation to execute the Save operation. To cancel the Save operation, press the [- / NO] button.

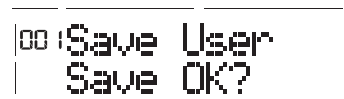
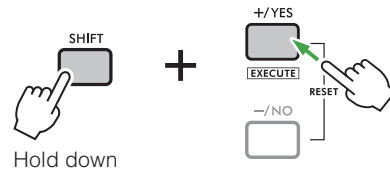

Overwriting Existing Files

If data had already been saved to the selected file, "Overwrite?" is shown in the lower display line.

- 5 Press the [+ / YES] button again to execute the Save operation.

"Saving" appears in the lower display line while the operation is being executed. After a while, a message indicating completion of the operation appears, and a User file (.usr) is saved to a "USER FILES" folder that was automatically created on the USB flash drive. When the Save operation is finished, "Complete" is shown in the lower display line. The "USER FILES" folder is automatically created on the USB flash drive.

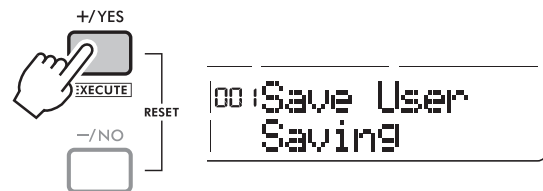

NOTICE

- The Save operation cannot be cancelled while it is being executed. Never turn off the instrument or disconnect the USB flash drive during the operation. Otherwise, data may be lost.

NOTE

- The amount of time required for this operation may vary depending on the condition of the USB flash drive.

- 6 To exit the File Control display, press the [SHIFT] button.

Loading a User File from USB Flash Drive

User data (page 93) saved as a User file (.usr) onto the USB flash drive can be loaded to this instrument.

NOTICE

- Loading a User file overwrites all existing data, including all 10 User Songs, Style data loaded to Styles 346 to 355, User chord progression data, all Registration Memory settings, and all Looper data. To keep important data, save it as a separate file onto a USB flash drive before loading.

NOTE

- For details on loading samples, refer to page 80.

1 Save the User files in the “USER FILES” folder on the USB flash drive.

Files saved outside the “USER FILES” folder are not recognized.

2 Connect a USB flash drive to the [USB TO DEVICE] terminal, and make sure that **USB** is shown (lit continuously) in the upper right of the display.



3 While holding down the [SHIFT] button, press the [FUNCTION] button to call up the File Control display.

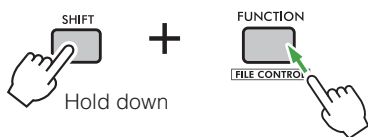

4 Rotate the [VOICE] dial until “Load User” (File Control Operation 002) is shown in the upper display line.

The name of a User file on the USB flash drive is shown in the lower display line as “USER****” (where “****” is a number). If necessary, rotate the [STYLE] dial to select the User file to be loaded.



5 While holding down the [SHIFT] button, press the [+ / YES] button.

“Load OK?” is shown in the lower display line for confirmation to execute the Load operation. To cancel the Load operation, press the [- / NO] button.

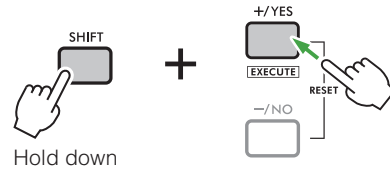

6 Press the [+ / YES] button to execute the Load operation.

“Loading” appears in the lower display line while the operation is being executed.



When the Load operation is finished, “Complete” is shown in the lower display line.

NOTICE

- The Load operation cannot be cancelled while it is being executed. Never turn off the instrument or disconnect the USB flash drive during the operation. Otherwise, data may be lost.

7 To exit the File Control display, press the [SHIFT] button.

8 Recall the loaded User data to check the contents.

Deleting a User File from USB Flash Drive

User Files (.usr) in the root directory of the USB flash drive can be deleted.

1 Save the User files that you wish to delete in the “USER FILES” folder on the USB flash drive.

Files saved outside the “USER FILES” folder are not recognized.

2 Connect a USB flash drive to the [USB TO DEVICE] terminal, and make sure that **USB** is shown (lit continuously) in the upper right of the display.



3 While holding down the [SHIFT] button, press the [FUNCTION] button to call up the File Control display.

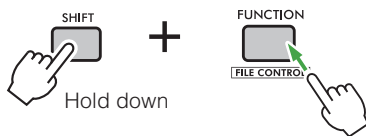

4 Rotate the [VOICE] dial until “Delete User” (File Control Operation 003) is shown in the upper display line.

The name of a User file on the USB flash drive is shown in the lower display line as “USER***” (where “***” is a number). If necessary, rotate the [STYLE] dial to select the file to be deleted.



5 While holding down the [SHIFT] button, press the [+ / YES] button.

“Delete OK?” is shown in the lower display line for confirmation to execute the Delete operation. To cancel the Delete operation, press the [- / NO] button.

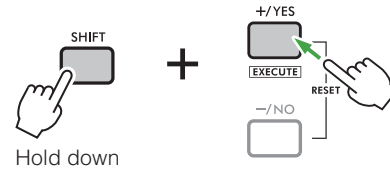

6 Press the [+ / YES] button to execute the Delete operation.

“Deleting” appears in the lower display line while the operation is being executed.



When the Delete operation is finished, “Complete” is shown in the lower display line.

NOTICE

- The Delete operation cannot be cancelled while it is being executed. Never turn off the instrument or disconnect the USB flash drive during the operation. Otherwise, data may be lost.

7 To exit the File Control display, press the [SHIFT] button.

List of Error Messages Related File Control Operations

Message	Description
Can't Use	Files cannot be used at this time because the USB flash drive is being read or written to.
Media Full	Data cannot be saved because the USB flash drive is full. Delete any unnecessary data, or use a different USB flash drive.
Error!	There is an error in the file, or an error occurred during the operation.
Protect	Writing is not possible because the USB flash drive is write-protected. Turn off the write-protect switch, or use a different USB flash drive that is not write-protected.
No File	There is no data in the memory.
No Data	There are no files in the memory.
Use Adapter	If batteries are used to power the instrument, writing to a USB flash drive is not possible. Use an AC adaptor.
Data Error	The data is not in the correct format.
File Full	The file(s) cannot be saved because the number of files exceeds the capacity. Delete any unnecessary data, or use a different USB flash drive.
Unformat	An unformatted USB flash drive is connected.

If "Ovr" Flashes After a USB Flash Drive Is Connected



If an overcurrent flows to the USB flash drive, communication between the instrument and the USB flash drive is cut, and "Ovr" flashes in the upper-left corner of the display. In this case, disconnect the USB flash drive from the [USB TO DEVICE] terminal, and then restart the instrument.

Connecting Other Devices

CAUTION

- Before connecting the instrument to other devices, turn off all of the devices. In addition, before turning the instrument on or off, make sure that all volume levels are set to the minimum. Otherwise, electrical shock, or damage to your hearing or the devices may result.

Connecting Headphones

Connect headphones to the **[PHONES]** jack. The instrument's speakers are automatically shut off when a plug is inserted into this jack. When using headphones with a mini plug, a stereo converter plug, as shown below, is required.

Connection Options

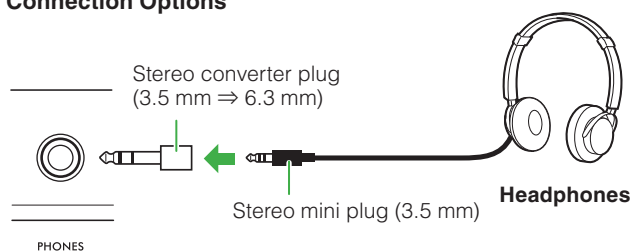

CAUTION

- Do not use headphones for a long period of time at a high or uncomfortable volume level. Otherwise, irreparable damage to your hearing may result.

NOTE

- If "Speaker" (page 112, Function 078 (PSR-E583)/ Function 077 (PSR-E483)) in the Function setting display is set to any setting other than "1 Phones Sw," the speakers can be turned on or off regardless of whether headphones are connected.
- When a plug is inserted into the [PHONES] jack, the instrument's speakers do not produce any sound. When the headphones are not being used, disconnect them (and the converter plug).

Connecting a Foot Switch

Connecting a foot switch (FC5 or FC4A, sold separately) to the **[FOOT SWITCH]** jack allows you to control three functions: Sustain, Articulation (page 24), and Arpeggio (page 26).



By default, the Sustain function is assigned to the foot switch. As with the damper pedal on a piano, pressing the foot switch sustains the sound even after you have released the keyboard keys. Select a setting other than "Sustain" in the Function setting display (page 109, Function 054).

NOTE

- Plug in or unplug the foot switch while the instrument is off. In addition, do not press the foot switch when turning the instrument on. Otherwise, the polarity of the foot switch is changed, resulting in reverse operation.
- Sustain is not applied to Split Voices (page 22).
- Some Voices will not decay until you release the foot switch.

Connecting a Foot Controller (PSR-E583 Only)

Connecting a foot controller (FC7, sold separately) to the **[FOOT CONTROLLER]** jack allows you to adjust the volume with your foot. Pushing it down further increases the volume, while releasing it decreases the volume.



The part whose volume is to be adjusted can be selected in the Function setting display (page 110, Function 055). By default, you can adjust the volume of parts such as keyboard Voices (Main, Dual, and Split), Styles, and Songs, but not audio.

Playing Sound over External Speakers

With powered speakers connected to the [OUTPUT] jacks, a louder, more powerful sound can be produced for more dynamic performances.

Connection Options

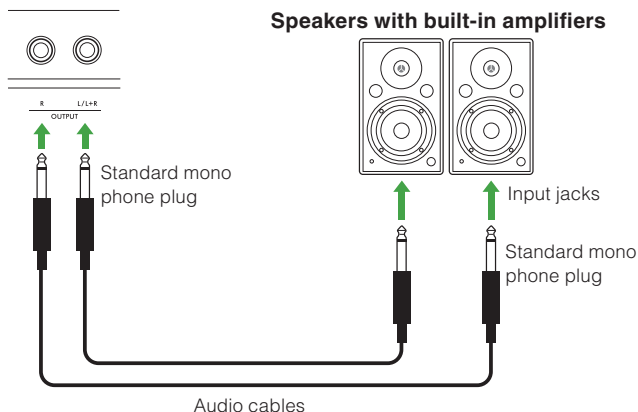

You can use the instrument's [MASTER VOLUME] control to adjust the volume that is output to external devices.

NOTICE

- In order to avoid damaging the external device over which the instrument sound will be played, first turn on the instrument, then the external device. When turning off the equipment, first turn off the external device, then the instrument.
- The Auto Power Off function (page 8) may automatically turn off the instrument at undesirable times. If the instrument will not be operated for a certain period of time, either turn off the external devices or deactivate the Auto Power Off function.
- Do not connect the [OUTPUT] jacks directly to the [AUX IN] jack. In addition, when an external device is connected to the [OUTPUT] jacks, do not connect the output jacks of the external device to the [AUX IN] jack. Making such connections will cause the audio that is input to the [AUX IN] jack to be output from the [OUTPUT] jacks, resulting in feedback that could damage both devices.

NOTE

- Use audio cables and adaptor plugs with zero resistance.
- When connecting a monaural device, use the [L/L+R] jack.

Turning Off the Keyboard's Speakers

Set "Speaker" (page 112, Function 078 (PSR-E583)/Function 077 (PSR-E483) in the Function setting display to "3 Speaker Off."

Playing an External Audio Device over the Built-in Speakers

Connecting an audio device, such as a smartphone, to the instrument's [AUX IN] jack allows you to output the sound from the audio device through the instrument's speakers. This lets you play the keyboard along with playback from the audio device, for practice or performance.

NOTICE

- In order to avoid damaging any device, first turn on the external device whose sound is to be played over the instrument's speakers, and then turn on the instrument. When turning off the equipment, first turn off the instrument, then the external device.

- 1 **Connect the headphone jack of an audio device to the instrument's [AUX IN] jack by using an audio cable.**

Connection Options

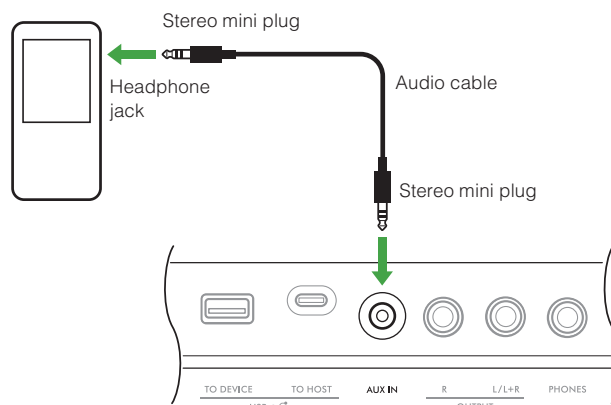

NOTE

- If you are using a computer or a smart device such as a smartphone or tablet, you can also connect it to the [USB TO HOST] terminal to play audio from that device over the instrument's speakers (page 99, 102).

- 2 **Turn on the audio device, then the instrument.**
- 3 **Start playback from the connected audio device.**
The sound of the audio device is output through the instrument's speakers.
- 4 **Adjust the volume balance between the audio device and the instrument.**
Adjust the playback volume of the audio device, and then adjust the overall volume by turning the [MASTER VOLUME] control on the instrument.

NOTE

- The knobs allow you to adjust the volume balance between the external audio input and the Style/Song. For details, refer to [page 47](#) to [page 49](#).
- The audio input volume from the **[AUX IN]** jack can be adjusted in the Function setting display ([page 111](#), [Function 069](#) (PSR-E583)/[Function 068](#) (PSR-E483)). Increasing the volume to more than 50 may cause the audio device sound to become distorted.

5 Play the keyboard along with the sound from the audio device.

NOTE

- You can decrease the volume of or mute the melody part of audio playback. Refer to the procedure in the following section, “Using the Melody Suppressor.”

6 After finishing your performance, stop playback from the audio device.

Using the Melody Suppressor

This function allows you to decrease the volume of the melody part of audio played back over the instrument’s speakers from an external audio device or a computer connected to the **[AUX IN]** jack or **[USB TO HOST]** terminal. This function is useful for practicing the melody part along with audio playback.

Specify the setting in the Function setting display ([page 112](#)).

- [Function 072](#) (PSR-E583)/[Function 071](#) (PSR-E483)
“Melody Suppressor”:
 Turns the Melody Suppressor function on and off.
- [Function 073](#) (PSR-E583)/[Function 072](#) (PSR-E483)
“Melody Suppressor Pan”:
 Adjusts the position for suppressing the melody.

NOTE

- When an audio device is connected to the **[USB TO HOST]** terminal and “Audio Loopback” ([page 111](#), [Function 071](#) (PSR-E583)/[Function 070](#) (PSR-E483)) in the Function setting display is set to “Off,” the Melody Suppressor function cannot be used.

Connecting to a Computer

Connecting the instrument to a computer by using a USB cable allows you to do the following:

- **Copy files, such as Styles and Songs**
- **Save backup files** ([page 114](#)) **to a computer**
- **Send and receive MIDI data**
- **Send and receive audio data (USB Audio Interface function)**

Connection Options

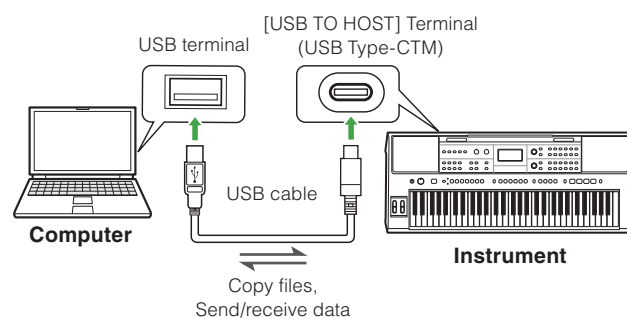

Precautions for Using the [USB TO HOST] Terminal

When connecting a computer to the [USB TO HOST] terminal, observe the following to prevent data loss due to the computer or instrument freezing (hanging up).

NOTICE

- The USB cable must be Type A-C or C-C and less than 3 meters long. In addition, use a cable that is not only for charging but also supports data communication in accordance with the USB standard.
- Before turning on/off the instrument or connecting/disconnecting the USB cable, be sure to observe the following.
 - Exit all applications.
 - Make sure that no data is being sent from the instrument. (Data is sent from the instrument whenever you are playing the keyboard or playing a Song.)
- Wait at least 6 seconds between turning the instrument on/off or connecting/disconnecting the USB cable.

If the computer or device stops working, restart the application or computer, or turn the device off, then on again.

Copying Song Files, Style Files, or Backup Files

This section describes the following two operations.

- Copying Song (MIDI) / Style files from a computer to the instrument
- Copying a backup file (.BUP, page 114) from the instrument to a computer

A feature called “Storage Mode” is used to import or export files. This feature allows you to easily manage files from the computer.

- 1 Turn the instrument off.
- 2 Connect the computer to the [USB TO HOST] terminal (page 12) on the rear panel by using a USB cable.

Connection Options

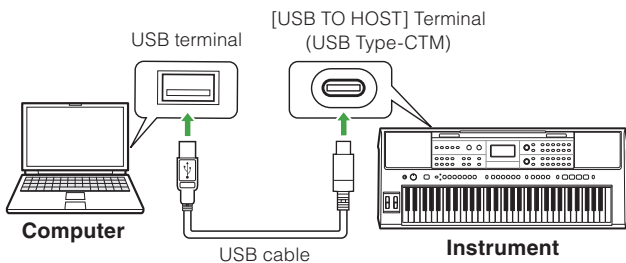

For precautions on making connections, refer to “Precautions for Using the [USB TO HOST] Terminal” on page 99.

- 3 Turn the instrument on.
- 4 Press the [FUNCTION] button to call up the Function setting display.

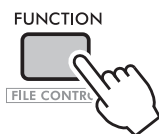

- 5 Rotate the [VOICE] dial until “Storage Mode” (Function 077 (PSR-E583)/Function 076 (PSR-E483)) is shown in the upper display line.



- 6 Rotate the [STYLE] dial to set “Storage Mode” to “On.”



- 7 From the computer screen, find the Backup file (.BUP).

After entering the Storage Mode in Step 6, the drive for the instrument is created and the Explorer application starts automatically on the computer screen.

The Backup file is named as follows:

- PSR-E583: PSR-E583.BUP
- PSR-E483: PSR-E483.BUP

Example: For Windows 11

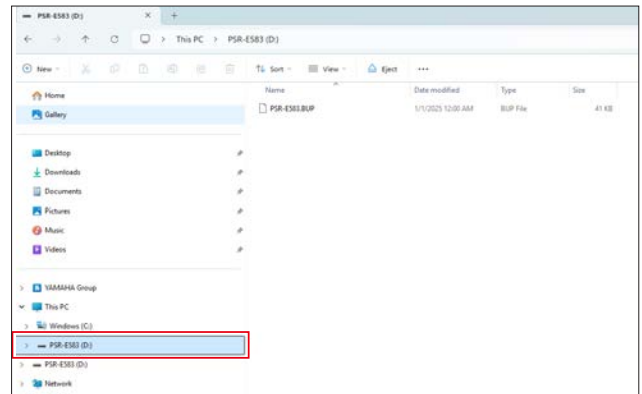

NOTE

- If the instrument does not have enough free space, an error message appears on the instrument when Storage Mode is turned on. Open an application such as File Explorer on the computer, and then delete Song files and Style files from the instrument to free up space.

8 From the computer, perform the File Copy operations.

- When you want to use the Song or Style file on the computer, copy the desired file from the computer drive to the instrument drive.
- When saving the Backup file on the instrument to the computer, copy the Backup file (.BUP) on the instrument drive to the computer drive.

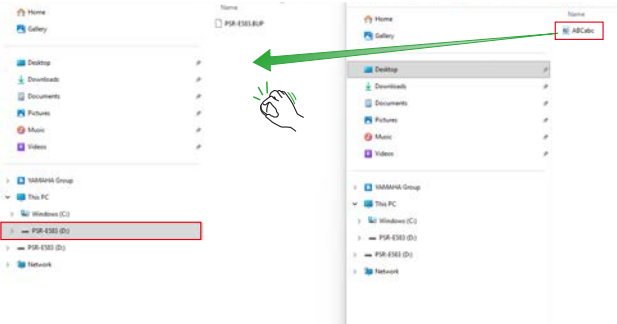

9 Once copying is finished, eject the instrument drive from the computer.

For Windows 11, click “Eject Digital Keyboard” as shown in the illustration below.

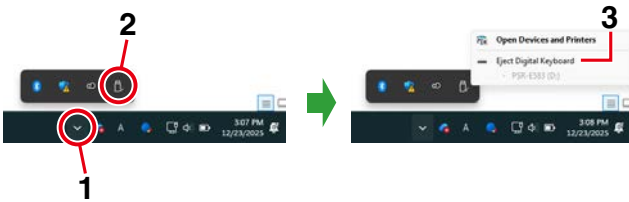

10 Rotate the [STYLE] dial to set “Storage Mode” to “Off.”



11 To return to the home display (page 14) from Storage Mode, press the [SHIFT] button.

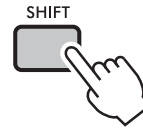

12 Disconnect the USB cable connecting the instrument and the computer.

13 Play the files on the instrument to check that they were copied correctly (page 102).

NOTICE

- Before disconnecting the USB cable from the computer, be sure to safely eject the instrument drive on the computer (step 9). Otherwise, the files may become damaged.
- Do not rename backup files (with the .BUP extension) on the computer. Otherwise, the backup data can no longer be imported into the instrument.
- When a backup file is imported back into the instrument, the currently specified instrument settings will be overwritten with the contents of the backup file. Please note that User Songs and saved Style files will also be overwritten.
- Do not create folders on the instrument drive. Otherwise, copied files may not be correctly recognized by the instrument.
- Do not format the instrument drive. Otherwise, the instrument may stop functioning properly.

Files That Can Be Copied (Approx. 1.5 MB Total)

- **Style files (.STY extension)**
Although this instrument does not have a function for creating Style files, it can import Style files created on other devices. The maximum size of a single Style file is 50 KB. Files that exceed this limit will not be recognized by the instrument.
- **Song files (.MID extension)**
Song files that have been created on other instruments or a computer can be copied onto this instrument. Note that it is not possible to copy User Songs created on this instrument as individual files to a computer.
- **Backup files (.BUP extension)**
Data in the instrument can be saved as a single backup file. For details on what information is saved, refer to “Data and Settings That Are Backed Up” (page 114).

Checking Copied Files

Play the files on the instrument to confirm that they were copied correctly.

● Style Files

In order to use the copied Style file on the instrument, that Style must first be loaded. Once the Style has been loaded into the instrument, try playing it.

For details on loading a Style file into the instrument, refer to [page 46](#).

For details on playing back a Style file, refer to [page 34](#).

● Song Files

Imported Song files are shown as Songs 13 and up.

- 1 Press the **MODE SELECT** button to select Song mode.
- 2 Rotate the **[STYLE]** dial to select the imported Song.
- 3 Press the **[▶ / ■]** (Start/Stop) button to start playback of the imported Song.

NOTE

- Files copied to the instrument are shown on the instrument in the following file name order: symbol → number → alphabet.

● Backup Files

Check that the settings, including recorded User Songs and imported Style files, have reverted to those in the imported backup file.

Sending/Receiving Data Between Computer/Smart Device and Instrument

Connecting a computer or smart device to the instrument allows you to send and receive MIDI data and audio data.

For details on connecting a computer to the instrument, refer to [page 99](#). For details on connecting a smart device to the instrument, refer to the Smart Device Connection Manual on the website ([page 2 of this document](#)).

Sending/Receiving MIDI Data

- **Sending:**
Performance information from the instrument can be sent to and saved on a computer or smart device.
- **Receiving:**
MIDI songs currently being played back on the computer or smart device can be played back over the instrument's speakers.

[Example]

Using music production software and music notation software on a computer

You can input notes into music production software or music notation software by using the instrument's keyboard.

Sending/Receiving Audio Data (USB Audio Function)

You can listen to audio data played on a computer or smart device over the instrument's speakers, or send a performance on the instrument as audio data to a computer.

For Windows:

A dedicated USB driver, "Yamaha Steinberg USB Driver," is required for sending and receiving audio data. Download "Yamaha Steinberg USB Driver" on the following webpage, and then install the driver onto the computer. For details on installation, refer to the Installation Guide included with the download file.

<https://manual.yamaha.com/mi/rt/psr-e483/software/>

For Mac:

Since the standard drivers provided with macOS can be used, no driver installation is required.

NOTICE

- When using this device with music production software such as a DAW (Digital Audio Workstation), set “Audio Loopback” (page 111, Function 071 (PSR-E583)/ Function 070 (PSR-E483)) in the Function setting display to “Off.” If the function is instead set to “On,” a mixture of audio data and instrument audio will be sent to the DAW, which may cause feedback and noise.

NOTE

- The volume of the audio input from the **[USB TO HOST]** terminal cannot be adjusted with the **[MASTER VOLUME]** control. Keep this in mind when mixing keyboard performance and audio input sounds for DAW recording.

Using Apps

Connecting the instrument to a computer or smart device allows you to use apps that are compatible with the instrument. With such apps, you can easily convert your favorite MIDI songs into Style files, record instrument performances, or transfer data from your instrument. For details on connecting a computer to the instrument, refer to page 99. For details on connecting a smart device to the instrument, refer to the Smart Device Connection Manual on the website (page 2 of this document).

Compatible Apps● **Computer Apps****MIDI Song to Style**

This application automatically converts SMF songs (Standard MIDI Files with .MID extension) into Style files (with .STY extension). This allows you to play your favorite songs as Styles on the instrument.

● **Smart Device Apps****Rec'n'Share**

You can film, record, and edit your instrument performance and upload the data to the Internet, such as social media.

**MusicSoft Manager**

You can transfer externally created song data (MIDI) from your smart device to the instrument, and save instrument backup files (.BUP) to your smart device.

For details on the apps, refer to the following website.

<https://www.yamaha.com/kbdapps/>

NOTE

- The USB cable must be Type A-C or C-C and less than 3 meters long.
- The audio input volume from the **[USB TO HOST]** terminal can be adjusted in the Function setting display (page 111, Function 070 (PSR-E583)/ Function 069 (PSR-E483)).

Function Settings

The Function settings provide access to a range of detailed instrument parameters such as Tuning, Split Point, Voices, and Effects. Find the desired item in the Function List (pages 104 to page 113), and then follow the instructions below.

Basic Procedure for the Function Settings

1 Press the [FUNCTION] button to call up the Function setting display.

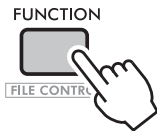

2 Rotate the [VOICE] dial until the desired Function name and number are shown.

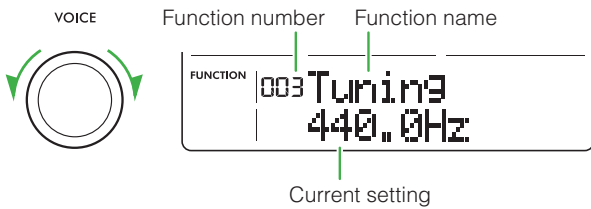

3 Rotate the [STYLE] dial to select the setting.

To revert to the default setting, simultaneously press the [+ / YES] and [/ NO] buttons.

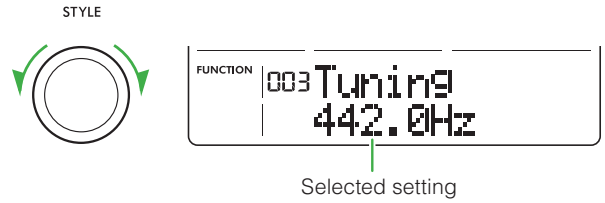

4 Press the [SHIFT] button to exit the Function setting display.



Function List

Function Number		Function	Display	Range/Settings	Default Value	Descriptions	Backup ✓ : Yes
PSR-E583	PSR-E483						
General							
001	001	Tempo Lock	Tempo Lock	On/Off	Off	Determines whether the tempo also changes when the Style is switched. <ul style="list-style-type: none"> On: The tempo from before the Style was switched is maintained, regardless of whether or not the switch is made during Style playback. Off: If the Style is switched during Style playback, the tempo from before the Style was switched is maintained. If the Style is switched with Style playback stopped, the tempo changes to the default tempo of the newly selected Style. 	
002	002	Transpose	Transpose	-12 to +12	0	Sets the pitch in semitones.	
003	003	Tuning	Tuning	427.0 Hz to 453.0 Hz	440.0 Hz	Determines the overall pitch of the instrument in increments of approximately 0.2 Hz.	✓
004	004	Pitch Bend Range	PB Range	1 to 12	2	Determines the range of change for pitch bending.	

Function Number		Function	Display	Range/Settings	Default Value	Descriptions	Backup ✓ : Yes
PSR-E583	PSR-E483						
005	005	Split Point	Split Point	036: C1 to 096: C6	054: F#2/G#2	Determines the point for dividing the keyboard into left and right areas. The specified key and the keys to the left of it become the left-hand area (Auto Accompaniment area).	✓
006	006	Touch Response	TouchResponse	1: Soft 2: Medium 3: Hard 4: Off	2: Medium	This function controls how the volume of the sound changes according to how hard you press the keys. Determines the sensitivity when playing the keyboard (the rate at which the volume changes depending on the strength with which you play the keyboard). For details on the settings, refer to page 18 .	✓
Main Voice							
007	007	Main Voice Volume	M.Volume	0 to 127	*	Determines the volume of the Main Voice.	
008	008	Octave	M.Octave	-2 to +2	*	Determines the octave range for the Main Voice.	
009	009	Pan	M.Pan	L63 to L01, C, R01 to R63	*	Determines the panning (position where audio is heard) of the Main Voice.	
010	010	Reverb Depth	M.Reverb	0 to 127	*	Determines the amount of Reverb applied to the Main Voice.	
011	011	Chorus Depth	M.Chorus	0 to 127	*	Determines the amount of Chorus applied to the Main Voice.	
012	012	Attack Time	M.Attack	0 to 127	64	Determines how fast the volume of the Main Voice reaches the Attack level. The larger the value, the slower the attack rate. The smaller the value, the faster the attack rate.	
013	013	Release Time	M.Release	0 to 127	64	Determines how fast the volume of the Main Voice falls to 0 when the key is released. The larger the value, the longer the sustain. The smaller the value, the shorter the sustain.	
014	014	Filter Cutoff	M.Cutoff	0 to 127	64	Determines the cutoff frequency. The higher the value, the brighter the sound.	
015	015	Filter Resonance	M.Resonance	0 to 127	64	Determines the amount of Resonance applied at the cutoff frequency. The higher the value, the bigger the emphasis on the frequencies at the cutoff frequency, which may result in an exaggerated peak.	

Function Settings

Function Number		Function	Display	Range/Settings	Default Value	Descriptions	Backup ✓ : Yes
PSR-E583	PSR-E483						
Dual Voice							
016	016	Dual Voice Volume	D.Volume	0 to 127	*	Determines the volume of the Dual Voice.	
017	017	Octave	D.Octave	-2 to +2	*	Determines the octave range for the Dual Voice.	
018	018	Pan	D.Pan	L63 to L01, C, R01 to R63	*	Determines the panning (stereo position where audio is heard) of the Dual Voice.	
019	019	Reverb Depth	D.Reverb	0 to 127	*	Determines the amount of Reverb applied to the Dual Voice.	
020	020	Chorus Depth	D.Chorus	0 to 127	*	Determines the amount of Chorus applied to the Dual Voice.	
021	021	Attack Time	D.Attack	0 to 127	64	Determines how fast the volume of the Dual Voice reaches the Attack level. The larger the value, the slower the attack rate. The smaller the value, the faster the attack rate.	
022	022	Release Time	D.Release	0 to 127	64	Determines how fast the volume of the Dual Voice falls to 0 when the key is released. The larger the value, the longer the sustain. The smaller the value, the shorter the sustain.	
023	023	Filter Cutoff	D.Cutoff	0 to 127	64	Determines the cutoff frequency. The higher the value, the brighter the sound.	
024	024	Filter Resonance	D.Resonance	0 to 127	64	Determines the amount of Resonance applied at the cutoff frequency. The higher the value, the bigger the emphasis on the frequencies at the cutoff frequency, which may result in an exaggerated peak.	
Split Voice							
025	025	Split Voice Volume	S.Volume	0 to 127	*	Determines the volume of the Split Voice.	
026	026	Octave	S.Octave	-2 to +2	*	Determines the octave range for the Split Voice.	
027	027	Pan	S.Pan	L63 to L01, C, R01 to R63	*	Determines the panning (stereo position where audio is heard) of the Split Voice.	
028	028	Reverb Depth	S.Reverb	0 to 127	*	Determines the amount of Reverb applied to the Split Voice.	
029	029	Chorus Depth	S.Chorus	0 to 127	*	Determines the amount of Chorus applied to the Split Voice.	

Function Number		Function	Display	Range/Settings	Default Value	Descriptions	Backup ✓ : Yes
PSR-E583	PSR-E483						
Style							
030	030	Style Volume	Style Volume	0 to 127	100	Determines the volume of the Style.	✓
031	031	Fingering Type	Fing. Type	1: Multi Finger 2: Smart Chord	1: Multi Finger	When playing back a Style, this determines the method for playing chords (Fingering Type) in the Auto Accompaniment area. For details on the Fingering Types, refer to page 36 .	✓
032	032	Style Key	Style Key	FL7 to FL1, SP0 to SP7 FL7 (7 ♭): C♭ Major/A♭ minor SP0 (no key signature): C Major/A minor SP7 (7 #): C# Major/A# minor	SP0 (no key signature): C Major/ A minor	When "Fingering Type" is set to "Smart Chord": Determines the key of the song based on the number of sharps (#) and flats (♭) shown in the score. If the key is set correctly, simply play the root note of a chord, and the chord that matches the song will be played automatically. <ul style="list-style-type: none">FL7 to FL1: When a song has 1 to 7 flats (♭)SP0: When a song has no sharps or flatsSP1 to SP7: When a song has 1 to 7 sharps (#)	
033	033	Chord Progression	Chord Prog.	001 to 110	001	Determines the chord progression to be played using the Auto Chord Play function (page 38). For details on chord progressions, refer to the Data List on the website.	
Song							
034	034	Song Volume	Song Volume	0 to 127	100	Determines the volume of the Song.	✓
035	035	Song Melody Voice	MelodyVcChg	001 to 860	**	Changes the Melody Voice of the selected Song to your desired Voice. For details on changing the setting, refer to page 56 .	
Looper							
036	036	Looper Undo	Looper Undo	1: Last Event 2: Last Timing 3: Last Loop	1: Last Event	Determines which parts to undo and re-record when using the Looper function. 1: Last Event..... Undoes the last recorded single note. 2: Last Timing..... Undoes the last recorded chord. 3: Last Loop Undoes the last recorded loop.	
037	037	Looper Volume	LooperVolume	0 to 127	100	Determines the volume of the phrase recorded with the Looper function.	

Function Settings

Function Number		Function	Display	Range/Settings	Default Value	Descriptions	Backup ✓ : Yes
PSR-E583	PSR-E483						
Effects							
038	038	Reverb Type	Reverb	01 to 04: Hall 05: Cathedral 06 to 09: Room 10 to 12: Stage 13 to 15: Plate 16: Off	**	Determines the type of Reverb (page 31). For details on the Reverb types, refer to the Data List on the website.	
039	039	Reverb Total Level	Reverb Level	0 to 127	64	Determines the amount of Reverb applied.	
040	040	Chorus Type	Chorus	1 to 3: Chorus 4 to 6: Flanger 7: Celeste 8: Off	**	Determines the type of Chorus (page 31). For details on the Chorus types, refer to the Data List on the website.	
041	041	Master EQ Type	Master EQ	1: Standard 2: Bright 1 3: Bright 2 4: Mellow 1 5: Mellow 2	1: Standard	Determines the sound produced by the instrument's built-in speakers. For details on Master EQ types, refer to page 32 .	✓
Microphone							
042	042	Microphone Volume	Mic Volume	0 to 127	Depends on the mic type	Determines the volume of the microphone input.	✓
043	043	Pan	Mic Pan	L63 to L01, C, R01 to R63	Depends on the mic type	Determines the panning (stereo position where audio is heard) of the microphone input. However, if the microphone is off or the Mic type is set to "TALK," "---" is shown, and this parameter cannot be set.	✓
044	044	Reverb Depth	Mic Reverb	0 to 127	Depends on the mic type	Determines the amount of Reverb applied to the microphone input. However, if the microphone is off or the Mic type is set to "TALK," "---" is shown, and this parameter cannot be set.	✓
045	045	Chorus Depth	Mic Chorus	0 to 127	Depends on the mic type	Determines the amount of Chorus applied to the microphone input. However, if the microphone is off or the Mic type is set to "TALK," "---" is shown, and this parameter cannot be set.	✓
Sampling							
046	046	Blank Cut	Blank Cut	On/Off	On	Determines whether ("On") or not ("Off") silent sections are cut automatically at the beginning and end of sampling.	✓
047	047	Sampling Pad Volume	Sampling Vol	000 to 127	100	Determines the volume of samples that are saved to the QUICK SAMPLING pads.	
048	048	Sampling Sync Playback	SamplingSync	On/Off	Off	Determines whether the sample is played back immediately when the QUICK SAMPLING pad is pressed, or whether the sample is played back from the beginning of a measure in sync with Style/Song playback.	

Function Number		Function	Display	Range/Settings	Default Value	Descriptions	Backup ✓ : Yes
PSR-E583	PSR-E483						
Harmony/Arpeggio							
049	049	Harmony Type	Harmony	01 to 26	*	Determines the type of Harmony. For details on the Harmony types, refer to the Data List on the website.	
050	050	Harmony Volume	Harmony Vol	0 to 127	*	Determines the volume of the Harmony effect.	
051	051	Arpeggio Type	Arpeggio	001 to 164	*	Determines the type of Arpeggio. For details on the Arpeggio types, refer to the Data List on the website.	
052	052	Arpeggio Velocity	Arp Velocity	1: Original 2: Key	**	Determines the velocity (strength) at which the Arpeggio is played back. 1: Original....Each Arpeggio is played at its default strength regardless of how hard the key is pressed. 2: KeyThe Arpeggio is played back with the strength used to press the key.	
053	053	Arpeggio Quantize	Arp Quantize	1: Off 2: 1/4 3: 1/8 4: 1/16	**	Confirms/changes the Arpeggio Quantize settings. Arpeggio Quantize is a function that corrects the timing of the Arpeggio audio so that it matches the playback and timing of the Song or Style. 1: OffNo correction is made. 2: 1/4.....Corrects the timing to sync with quarter notes. 3: 1/8.....Corrects the timing to sync with eighth notes. 4: 1/16.....Corrects the timing to sync with sixteenth notes.	
Pedal							
054	054	Foot Switch	Foot Switch	1: Sustain 2: Arpeggio Hold 3: Sustain+Arpeggio Hold 4: Articulation	1: Sustain	Determines the Function assigned to the pedal (foot switch) connected to the [FOOT SWITCH] jack. 1: Sustain...The sound is sustained, even after the keys have been released, as long as the pedal is pressed. 2: Arpeggio Hold.....Arpeggio playback continues, even after the keys have been released, as long as the pedal is pressed. 3: Sustain+Arpeggio HoldThe sound is sustained and Arpeggio playback continues, even after the keys have been released, as long as the pedal is pressed. 4: ArticulationAn Articulation effect is applied as long as the pedal is pressed.	

Function Settings

Function Number		Function	Display	Range/Settings	Default Value	Descriptions	Backup ✓ : Yes
PSR-E583	PSR-E483						
055	-	Foot Controller	Foot Control	1: All 2: Keyboard	1: All	Determines the part whose volume is adjusted with the foot controller connected to the [FOOT CONTROLLER] jack. 1: AllAll parts such as keyboard Voices, Styles, Songs, and looped and sampled sounds, but not audio from the [MIC INPUT]/[AUX IN] jacks and [USB TO HOST]/[USB TO DEVICE] terminals 2: Keyboard..... Only keyboard Voices (Main, Dual, and Split)	
Scale Tuning (Temperament)							
056	055	Scale	Scale	1: Equal (equal temperament) 2: Pure Major 3: Pure Minor 4: Bayat (Arabic) 5: Rast (Arabic)	1: Equal (equal temperament)	Determines the temperament to use. If the temperament is changed, the pitch of each key will change. If an original temperament has been set by using Function 058 (PSR-E583)/ 057 (PSR-E483) and Function 059 (PSR-E583)/ 058 (PSR-E483), "(Edited)" is shown in the display. Selecting a setting between 1 and 5 will cause the original temperament to be lost.	
057	056	Base Note	Base Note	01: C, 02: C#/D \flat , 03: D, 04: D#/E \flat , 05: E, 06: F, 07: F#/G \flat , 08: G, 09: G#/A \flat , 10: A, 11: A#/B \flat , 12: B	01: C	Determines the tonic note of the scale. Be sure to select the appropriate base note (or tonic) when a "Scale" setting other than "Equal" has been selected, or an original temperament has been created by using the Tune Note function.	
058	057	Tuning Note	Tune Note	01: C, 02: C#/D \flat , 03: D, 04: D#/E \flat , 05: E, 06: F, 07: F#/G \flat , 08: G, 09: G#/A \flat , 10: A, 11: A#/B \flat , 12: B	01: C	Determines the pitch of individual notes. You can use this Function to set your own temperament. • 058 (PSR-E583)/057 (PSR-E483) "Tuning Note": Selects the notes to set the pitch.	
059	058	Tuning	Tune	-64 to 63	Depends on the scale	• 059 (PSR-E583)/058 (PSR-E483) "Tuning": Determines the pitch of the note. Determines the difference from equal temperament in units of 1 cent (a unit of pitch that is 1/100th of a semitone). If the setting for Function 056 (PSR-E583)/ 055 (PSR-E483) "Scale" is changed after making the above settings, all original temperament settings will be erased. After creating an original temperament, we recommend saving it to Registration Memory (page 71).	

Function Number		Function	Display	Range/Settings	Default Value	Descriptions	Backup ✓ : Yes
PSR-E583	PSR-E483						
Metronome							
060	059	Time Signature Numerator	Time Sig Top	00 to 60	**	Determines the time signature of the Metronome.	
061	060	Time Signature Denominator	Time Sig Btm	2 (half note) 4 (quarter note) 8 (eighth note) 16 (sixteenth note)	**	Determines the length of each metronome beat.	
062	061	Metronome Volume	MetronomeVol	0 to 127	100	Determines the volume of the Metronome.	✓
MIDI							
063	062	Local Control	LocalControl	On/Off	On	Determines whether ("On") or not ("Off") the instrument's keyboard controls the internal tone generator.	
064	063	External Clock	Ext Clock	On/Off	Off	Determines whether the instrument's automatic playback (Songs, Style, etc.) synchronizes to the internal clock ("Off") or an external clock ("On").	
065	064	Keyboard Out	Keyboard Out	On/Off	On	Determines whether ("On") or not ("Off") keyboard performance information is transmitted as MIDI messages via the [USB TO HOST] terminal.	
066	065	Style Out	Style Out	On/Off	Off	Determines whether ("On") or not ("Off") Style playback performance information is transmitted as MIDI messages via the [USB TO HOST] terminal.	
067	066	Song Out	Song Out	On/Off	Off	Determines whether ("On") or not ("Off") Song playback performance information is transmitted as MIDI messages via the [USB TO HOST] terminal.	
068	067	Initial Send	Initial Send	-	-	Allows you to send the data of the panel settings to a computer. Press the [-/YES] button to execute the operation; press the [-/NO] button to cancel the operation. When you record your keyboard performance to a computer app via MIDI, it is best to execute this Function immediately after starting recording.	
Audio							
069	068	Audio Volume [AUX IN]	Aux In Vol	0 to 127	50	Determines the volume of audio playback that is input from the [AUX IN] jack.	✓
070	069	Audio Volume [USB TO HOST]/ [USB TO DEVICE]	USB In Vol	0 to 127	100	Determines the volume of the following: <ul style="list-style-type: none"> • Audio input from the [USB TO HOST] terminal • Playback of an audio file on a USB flash drive connected to the [USB TO DEVICE] terminal 	✓
071	070	Audio Loopback	Loopback	On/Off	On	Determines whether the audio input from the [USB TO HOST] terminal is layered with the instrument performance, then output back to the computer. To output only the sound played on this instrument to the computer, set this parameter to "Off."	✓

Function Settings

Function Number		Function	Display	Range/Settings	Default Value	Descriptions	Backup ✓ : Yes
PSR-E583	PSR-E483						
072	071	Melody Suppressor	Melody SUPPR	On/Off	Off	When the audio of an external audio device connected to the [AUX IN] jack or a computer connected to the [USB TO HOST] terminal is output over this instrument's speakers: Determines whether ("On") or not ("Off") to cancel or lower the volume of the melody part.	
073	072	Melody Suppressor Pan	MelSUPPR Pan	L63 to L01, C, R01 to R63	C	When "Melody Suppressor" is set to "On": Determines the panning (stereo position where audio is heard) for cancelling or lowering the volume of the audio.	
Registration Freeze							
074	073	Style Freeze	Style Freeze	On/Off	Off	Set to "On" to prevent the Style setting from changing, instead maintaining (freezing) it at the current setting, when settings are recalled from Registration Memory.	✓
075	074	Transpose Freeze	Trans Freeze	On/Off	Off	Set to "On" to prevent the Transpose setting from changing, instead maintaining (freezing) it at the current setting, when settings are recalled from Registration Memory.	✓
076	075	Voice Freeze	Voice Freeze	On/Off	Off	Set to "On" to prevent the Voice setting from changing, instead maintaining (freezing) it at the current setting, when settings are recalled from Registration Memory.	✓
Storage							
077	076	Storage Mode	Storage Mode	On/Off	Off	Set to "On" to transfer files between the instrument and a computer. While Storage Mode is on, you cannot play the instrument.	
Speakers							
078	077	Speaker	Speaker	1: Phones Sw 2: Speaker On 3: Speaker Off	1: Phones Sw	Determines whether to output audio over the instrument's speakers. 1: Phones Sw When headphones are connected, audio is output from the headphones, but not the speakers. When headphones are not connected, audio is output from the speakers. 2: Speaker On Audio is output from the speakers, regardless of whether or not headphones are connected. 3: Speaker Off Audio is not output from the speakers, regardless of whether or not headphones are connected.	

Function Number		Function	Display	Range/Settings	Default Value	Descriptions	Backup ✓ : Yes
PSR-E583	PSR-E483						
Power Supply							
079	078	Auto Power Off	AutoPowerOff	Disabled, 5/10/15/30/60/120 (minutes)	15 (minutes)	Determines the time that will elapse before the instrument is automatically turned off. When set to "Disabled," the instrument does not turn off automatically.	✓
080	079	Battery	Battery	1: Alkaline 2: Ni-MH	1: Alkaline	Determines the type of batteries to be used. 1: Alkaline...Alkaline or manganese batteries 2: Ni-MH....Rechargeable nickel metal hydride batteries	✓
Language							
081	080	Language	Language	English/Japanese	English	Determines the language for showing the names of files on USB flash drives, and files transferred from a computer to the instrument. However, double-byte characters are not shown in the display, even if "Japanese" is selected.	✓

* The appropriate setting is automatically specified for the selected Voice combination.

** The appropriate setting is automatically specified for the currently selected Style/Song/Arpeggio.

Backup and Initialization

Data and Settings That Are Backed Up

The following data and settings on this instrument are maintained, even after it is turned off. The storage area is divided into a Backup area and a Flash area.

Backup area (Reset with Backup Clear operation)

- User Songs ([page 60](#))
- Styles loaded from external devices (Styles 346 to 355) ([page 46](#))
- Samples saved to QUICK SAMPLING pads ([page 73](#))
- Looper data ([page 82](#))
- User chord progression data ([page 39](#))
- Registration Memory (*1) ([page 70](#))
- Function settings (*1 *2) ([page 104](#))

*1 The data is saved and updated when the instrument is turned off.

NOTICE

If the instrument is turned off under the following circumstances, the settings will not be saved, and the results of any operations performed after the instrument is turned on again will be lost.

- Disconnected AC adaptor while supplying power to the instrument
- Power failure
- Low or no battery power when only batteries are being used
- AC adaptor connected when only batteries are being used

*2 Settings of Functions with a check mark in the "Backup" column of the Function List (pages [104](#) to [page 113](#)) are backed up.

Flash area (Reset with Flash Clear operation)

- All Songs copied from a computer ([page 102](#))
- All Styles copied from a computer ([page 102](#))

Backup files (.BUP)

- All data and settings in the Backup area are written from the Backup area to the Flash area as a single compressed file, "Backup file" (.BUP), when the Storage Mode ([page 112](#)) is turned on and the device communicates with a computer. The written Backup file can be saved to a computer.
- Backup files (.BUP) saved to a computer or smart device can be used to restore the instrument when needed. After Storage Mode is turned on and the Backup file from the computer is copied back onto the instrument, the data and settings from the Backup file will be written back to the Backup area when Storage Mode is turned off.
For details on copying the Backup file, refer to [page 100](#).

NOTE

- The size of the Backup file varies depending on the amount of data stored on the instrument. The maximum size is approximately 618 KB.

Initializing the Instrument

Clearing the Backup data and reverting all instrument settings to their factory defaults is called "initialization."

Erasing Backup Data (Backup Clear)

All data in the Backup area will be erased, and all settings will be reverted to their factory defaults. While holding down the highest white key, press the [⏻] (Standby/On) switch to turn on the instrument.

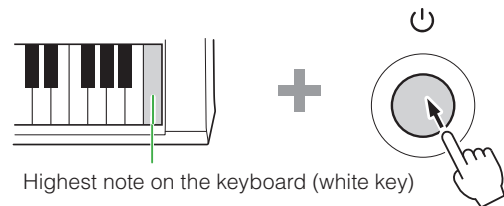

Deleting Files Transferred from a Computer, etc. (Flash Clear)

All data in the Flash area will be erased. While simultaneously holding down the highest white key and the three highest black keys, press the [⏻] (Standby/On) switch to turn on the instrument.

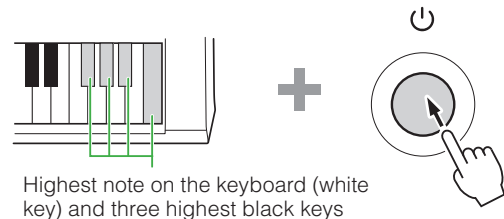

NOTICE

- Before initialization, be sure to transfer or save to a computer or smart device any data that you wish to keep. Initializing with the Flash Clear operation may also delete any data you have purchased and loaded.

Block Diagram

Block Diagram

This shows the connections (signal path) of the effects built into this product, allowing you to see how effects are applied to the sound of each part.

Legend

Content enclosed within : These are the effects built into this instrument.

: This indicates where a line splits into multiple branches or where multiple branches join together.

: This indicates that the depth is adjustable.

Reading the Diagram

The sound of each part flows from left to right in the diagram below, and effects are applied in that order.

For example, the Main signal first passes through DSP1, then DSP2, Chorus, Reverb, and finally through Master EQ and Mega Boost.

Unlike Main, Dual and Split do not pass through DSP1, so you can see that DSP1 is not applied.

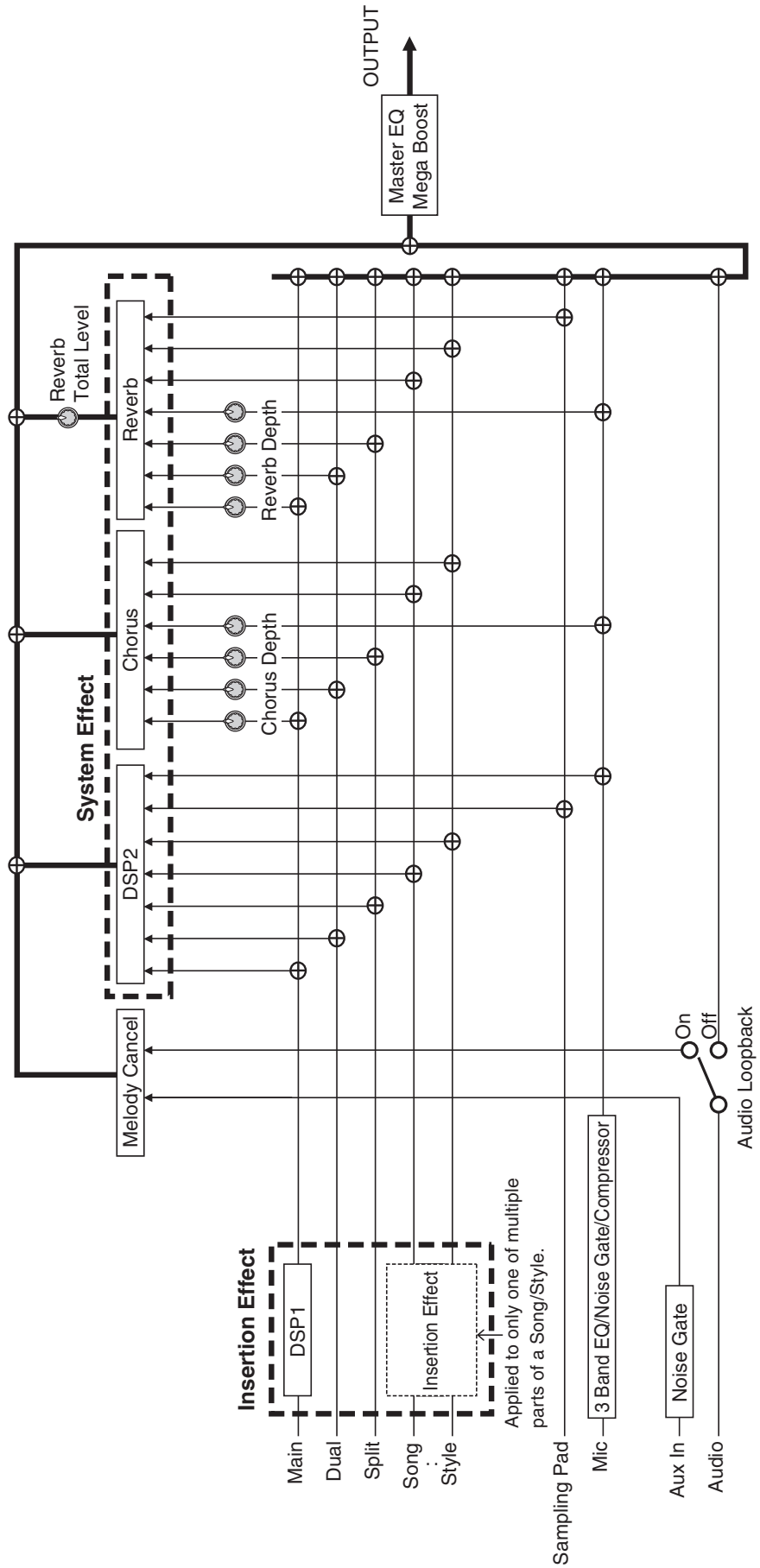

Troubleshooting

Problem	Possible Cause and Solution
When the instrument is turned on by pressing the [⏻] (Standby/On) switch, a popping sound is temporarily produced.	This is normal and indicates that the instrument is receiving electrical power.
When the instrument is turned on by pressing the [⏻] (Standby/On) switch, the instrument turns off suddenly and unexpectedly.	This is because the overvoltage protection function has been activated. If an AC adaptor other than the one specified is used, the instrument may turn off suddenly and unexpectedly. Use only the specified AC adaptor.
Noise is produced over the instrument's speakers and/or headphones.	If a mobile phone/smartphone is being used (or ringing) near the instrument, it may produce interference. To prevent this, turn off the mobile phone/smartphone, or use it in Airplane mode.
The instrument automatically turns off, even when no operation is performed.	This is caused by the Auto Power Off function (page 8). Change the time until the instrument is automatically turned off, or deactivate the function.
<ul style="list-style-type: none"> • The volume is too low. • The sound quality is poor. • The Style/Song/Arpeggio stops unexpectedly or will not play. • Recorded data, for example, of a Song, is not played back correctly. • The LCD display suddenly goes dark, and all panel settings are reset. • The instrument turns off when a USB flash drive is being connected. 	The battery is depleted. Replace all batteries with brand new or fully recharged ones, or use the AC adaptor.
No sound is produced when the keyboard is played. No sound is produced when a Song or Style is played back.	<p>Make sure that no headphones or a headphone converter plug is connected to the [PHONES] jack (page 97).</p> <p>Function 078 (PSR-E583)/Function 077 (PSR-E483) "Speakers" (page 112) is set to "3 Speaker Off." Set it to either "1 Phones SW" or "2 Speaker On."</p>
The foot switch (for sustain) seems to produce the opposite effect. For example, pressing the foot switch cuts off the sound and releasing it sustains the sound.	This happens either because you were stepping on the foot switch while turning on the instrument, or the foot switch was connected/disconnected while the instrument is on. Turn off the instrument, and then turn it on again while being careful not to step on the foot switch.
When playing the keyboard, some keys do not produce sound when pressed simultaneously. Furthermore, the sound seems to cut off when a Style, Song, Arpeggio or the QUICK SAMPLING pads are being played.	The maximum polyphony (64 sounds) has been exceeded. If the maximum polyphony has been exceeded, earlier notes are muted and subsequent notes are given priority.
The sound quality and volume vary depending on which key is pressed.	In order to faithfully reproduce the original sound of an instrument, this instrument has samples of the original instrument across the range of its keyboard. As a result, some Voices may have different sound quality and volume depending on their range.
The keyboard performance and playback of a Style/Song produces an unexpected sound, such as distortion or excessive reverb, which cannot be returned to normal.	An unintended setting was made due to operation of the knobs. Press the [PORTABLE GRAND] button to reset the panel settings.
The Song/Style does not start even after the [START/STOP] button has been pressed. Arpeggio does not start even if a key is pressed with the Arpeggio function turned on.	Function 064 (PSR-E583)/Function 063 (PSR-E483) "External Clock" (page 111) is set to "On." Normally, "External Clock" should be set to "Off."
The volume of a Style/Song is too low.	The volume levels for a Style and Song can be set separately (page 107). Make sure that the volume settings for each function are not too low.

Problem	Possible Cause and Solution
Style parts other than Rhythm produce no sound.	Style (ACMP) is not on. Press the SEQUENCER CONTROL [ACMP] button so that it lights up.
When certain Styles are selected, no rhythm is played even after the [START/STOP] button has been pressed.	The selected Style does not include a rhythm part. Press the SEQUENCER CONTROL [ACMP] button so that it lights up, and then play the left-hand area of the keyboard (page 33) to play back the accompaniment part of the Style.
The instrument cannot enter Audio Recording Standby mode.	If batteries are used to power the instrument, audio recording is not available. Use an AC adaptor.
The instrument does not respond when operated.	Function 077 (PSR-E583)/Function 076 (PSR-E483) "Storage Mode" (page 112) is set to "On." Set "Storage Mode" to "Off."
The Style corresponding to the played chord is not played back.	The setting for Function 031 "Fingering Type" (page 107) does not fit how the chords are being played. Check the settings. For details on how these settings affect the way the instrument recognizes played chords, refer to page 44 to 45.
	The setting for Function 005 "Split Point" (page 105) is not correct. Specify an appropriate setting.
	If Function 031 "Fingering Type" (page 107) is set to "1 Multi Finger," the following responses to user operations may occur. However, this is normal. <ul style="list-style-type: none"> • If similar chords are played in succession (such as a minor seventh chord followed by a minor chord with the same root note), the Style may not change. • If only two keys are played, the optimum chord will be detected based on the most recently played chord. • If an octave is played, only the root note will be heard in the accompaniment.
The smart device app does not recognize the instrument.	Function 077 (PSR-E583)/Function 076 (PSR-E483) "Storage Mode" (page 112) is set to "On." Set "Storage Mode" to "Off."
"LowInput" appears in the display, and sampling cannot be performed.	Function Function 071 (PSR-E583)/Function 070 (PSR-E483) "Audio Loopback" (page 111) is set to "Off." In this case, the audio input to the sampling function is also turned off. Set "Audio Loopback" to "On," and then try sampling again.

Index

A		H		Q	
A-B Repeat	55	Harmony	25	Quick Sampling	73
AC Adaptor	6	Harmony Type.....	25	R	
app.....	103	I		Recording	60
Arpeggio	26	Initialization.....	114	Registration Memory	70
Articulation.....	24	Intro	41	Repeat (loop) playback (User Song)...	56
Audio Device.....	98	K		Reverb	31
Audio File.....	52, 54, 68	Knob	47	Reverb Type.....	31
Audio Recording	60, 68	L		Revoicing	43
Auto Accompaniment.....	33	Looper	82	S	
Auto Chord Play.....	38	M		Sampling.....	73
Auto Power Off.....	8	Main.....	41	S. Art Lite Voice.....	24
B		Main Voice	20	Scale Tuning (Temperament)	50
Backup.....	114	Master EQ	32	Section.....	41
Base Note	50	Master Volume.....	8	Smart Chord	36, 45
Batteries.....	6	Mega Boost	18	Smart Device	102
Block Diagram	115	Melody Suppressor.....	99	Song	52, 53
C		Message List	54, 69, 96	Song Book.....	2
Chord Progression	39	Metronome	16, 17	Song Data.....	2
Chorus	31	Metronome Volume.....	16	Song Recording	60
Computer	99, 102	Microphone.....	58	Song Volume	53
Chorus Type.....	31	MIDI	52, 53	Speakers	98
D		MIDI Recording.....	60	Split Point.....	22
Demo Song.....	53	Motion Effect.....	30	Style	33
DSP	28	Multi Finger.....	36, 44	Style Key	37
Dual Voice.....	21	Music Rest.....	8	Style Revoicing.....	43
Display.....	14, 15	O		Style (Volume)	35
E		One-Touch Setting	20	Sync Start	34
Ending	41	OTS	20	Sync Stop	42
External Speakers	98	P		Split Voice	22
Effect.....	19	Pause	55	T	
F		Pedal (Foot Switch).....	97	Temperament.....	50
Fast Forward.....	55	Pitch Bend Wheel	32	Tempo.....	16
Fast Reverse.....	55	Playback (Audio).....	54	Time Signature	17
File Control	90	Playback (Song)	53	Touch Response.....	18
File Copying.....	100	PORTABLE GRAND.....	20	Touch Sensitivity.....	18
Fingering Type	36	Power.....	6, 8	Track (Recording)	63
Foot Switch.....	97			Track (Song)	57
Formatting.....	92			Track (Style).....	42
Freeze.....	72			Transpose	19
Function Settings	104			Troubleshooting	116
				Tuning	19, 51

U

USB Audio 102
USB Flash Drive 89
User Songs..... 52, 60

V

Video Manuals..... 2
Voices (Instrument)..... 20
Volume..... 8
Volume (Song)..... 53
Volume (Style) 35
Voice (Instrument) 20
Volume (Metronome) 16