



CD-S700

Compact Disc Player

Lecteur Compact Disque

OWNER'S MANUAL
MODE D'EMPLOI

IMPORTANT SAFETY INSTRUCTIONS

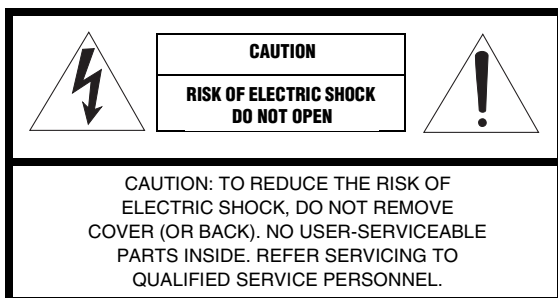

• Explanation of Graphical Symbols



The lightning flash with arrowhead symbol, within an equilateral triangle, is intended to alert you to the presence of uninsulated "dangerous voltage" within the product's enclosure that may be of sufficient magnitude to constitute a risk of electric shock to persons.



The exclamation point within an equilateral triangle is intended to alert you to the presence of important operating and maintenance (servicing) instructions in the literature accompanying the appliance.

IMPORTANT

Please record the serial number of this unit in the space below.

MODEL:

Serial No.:

The serial number is located on the rear of the unit.

Retain this Owner's Manual in a safe place for future reference.

FOR CANADIAN CUSTOMERS

To prevent electric shock, match wide blade of plug to wide slot and fully insert.

This Class B digital apparatus complies with Canadian ICES-003.

- 1 Read these instructions.
- 2 Keep these instructions.
- 3 Heed all warnings.
- 4 Follow all instructions.
- 5 Do not use this apparatus near water.
- 6 Clean only with dry cloth.
- 7 Do not block any ventilation openings. Install in accordance with the manufacturer's instructions.
- 8 Do not install near any heat sources such as radiators, heat registers, stoves, or other apparatus (including amplifiers) that produce heat.
- 9 Do not defeat the safety purpose of the polarized or grounding-type plug. A polarized plug has two blades with one wider than the other. A grounding type plug has two blades and a third grounding prong. The wide blade or the third prong are provided for your safety. If the provided plug does not fit into your outlet, consult an electrician for replacement of the obsolete outlet.
- 10 Protect the power cord from being walked on or pinched particularly at plugs, convenience receptacles, and the point where they exit from the apparatus.
- 11 Only use attachments/accessories specified by the manufacturer.
- 12 Use only with the cart, stand, tripod, bracket, or table specified by the manufacturer, or sold with the apparatus. When a cart is used, use caution when moving the cart/apparatus combination to avoid injury from tip-over.
- 13 Unplug this apparatus during lightning storms or when unused for long periods of time.
- 14 Refer all servicing to qualified service personnel. Servicing is required when the apparatus has been damaged in any way, such as power-supply cord or plug is damaged, liquid has been spilled or objects have fallen into the apparatus, the apparatus has been exposed to rain or moisture, does not operate normally, or has been dropped.



We Want You Listening For A Lifetime

Yamaha and the Electronic Industries Association's Consumer Electronics Group want you to get the most out of your equipment by playing it at a safe level. One that lets the sound come through loud and clear without annoying blaring or distortion – and, most importantly, without affecting your sensitive hearing. Since hearing damage from loud sounds is often undetectable until it is too late, Yamaha and the Electronic Industries Association's Consumer Electronics Group recommend you to avoid prolonged exposure from excessive volume levels.



FCC INFORMATION (for US customers)

1 IMPORTANT NOTICE: DO NOT MODIFY THIS UNIT!

This product, when installed as indicated in the instructions contained in this manual, meets FCC requirements. Modifications not expressly approved by Yamaha may void your authority, granted by the FCC, to use the product.

2 IMPORTANT: When connecting this product to accessories and/or another product use only high quality shielded cables. Cable/s supplied with this product **MUST** be used. Follow all installation instructions. Failure to follow instructions could void your FCC authorization to use this product in the USA.

3 NOTE: This product has been tested and found to comply with the requirements listed in FCC Regulations, Part 15 for Class "B" digital devices. Compliance with these requirements provides a reasonable level of assurance that your use of this product in a residential environment will not result in harmful interference with other electronic devices.

This equipment generates/uses radio frequencies and, if not installed and used according to the instructions found in the users manual, may cause interference harmful to the operation of other electronic devices.

Compliance with FCC regulations does not guarantee that interference will not occur in all installations. If this product is found to be the source of interference, which can be determined by turning the unit "OFF" and "ON", please try to eliminate the problem by using one of the following measures:

Relocate either this product or the device that is being affected by the interference.

Utilize power outlets that are on different branch (circuit breaker or fuse) circuits or install AC line filter/s.

In the case of radio or TV interference, relocate/reorient the antenna. If the antenna lead-in is 300 ohm ribbon lead, change the lead-in to coaxial type cable.

If these corrective measures do not produce satisfactory results, please contact the local retailer authorized to distribute this type of product. If you can not locate the appropriate retailer, please contact Yamaha Electronics Corp., U.S.A. 6660 Orangethorpe Ave., Buena Park, CA 90620.

The above statements apply **ONLY** to those products distributed by Yamaha Corporation of America or its subsidiaries.

CAUTION

Use of controls or adjustments or performance of procedures other than those specified herein may result in hazardous radiation exposure.

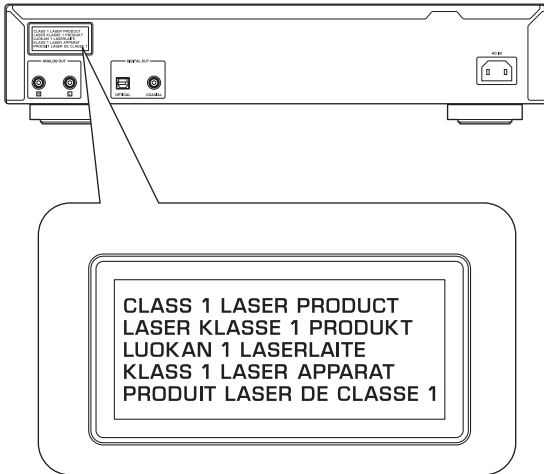

- This label is attached to U.K. model only.

■ For U.K. customers

If the socket outlets in the home are not suitable for the plug supplied with this appliance, it should be cut off and an appropriate 3 pin plug fitted. For details, refer to the instructions described below.

Note

The plug severed from the mains lead must be destroyed, as a plug with bared flexible cord is hazardous if engaged in a live socket outlet.

■ Special Instructions for U.K. Model

IMPORTANT

THE WIRES IN MAINS LEAD ARE COLOURED IN ACCORDANCE WITH THE FOLLOWING CODE:

Blue: NEUTRAL

Brown: LIVE

As the colours of the wires in the mains lead of this apparatus may not correspond with the coloured markings identifying the terminals in your plug, proceed as follows:

The wire which is coloured **BLUE** must be connected to the terminal which is marked with the letter **N** or coloured **BLACK**. The wire which is coloured **BROWN** must be connected to the terminal which is marked with the letter **L** or coloured **RED**.

Making sure that neither core is connected to the earth terminal of the three pin plug.

CAUTION: READ THIS BEFORE OPERATING YOUR UNIT.

- 1 To assure the finest performance, please read this manual carefully. Keep it in a safe place for future reference.
- 2 Install this sound system in a well ventilated, cool, dry, clean place – away from direct sunlight, heat sources, vibration, dust, moisture, and/or cold. Allow ventilation space of at least 10 cm (3 15/16 in) on the top, 10 cm (3 15/16 in) on the left and right, and 10 cm (3 15/16 in) on the back of this unit.
- 3 Locate this unit away from other electrical appliances, motors, or transformers to avoid humming sounds.
- 4 Do not expose this unit to sudden temperature changes from cold to hot, and do not locate this unit in an environment with high humidity (i.e. a room with a humidifier) to prevent condensation inside this unit, which may cause an electrical shock, fire, damage to this unit, and/or personal injury.
- 5 Avoid installing this unit where foreign objects may fall onto this unit and/or this unit may be exposed to liquid dripping or splashing. On the top of this unit, do not place:
 - Other components, as they may cause damage and/or discoloration on the surface of this unit.
 - Burning objects (i.e. candles), as they may cause fire, damage to this unit, and/or personal injury.
 - Containers with liquid in them, as they may fall and liquid may cause electrical shock to the user and/or damage to this unit.
- 6 Do not cover this unit with a newspaper, tablecloth, curtain, etc. in order not to obstruct heat radiation. If the temperature inside this unit rises, it may cause fire, damage to this unit, and/or personal injury.
- 7 Do not plug in this unit to a wall outlet until all connections are complete.
- 8 Do not operate this unit upside-down. It may overheat, possibly causing damage.
- 9 Do not use force on switches, knobs and/or cables.
- 10 When disconnecting the power cable from the wall outlet, grasp the plug; do not pull the cable.
- 11 Do not clean this unit with chemical solvents; this might damage the finish.
- 12 Only voltage specified on this unit must be used. Using this unit with a higher voltage than specified is dangerous and may cause fire, damage to this unit, and/or personal injury. Yamaha will not be held responsible for any damage resulting from use of this unit with a voltage other than specified.
- 13 To prevent damage by lightning, keep the power cable disconnected from a wall outlet or the unit during a lightning storm.
- 14 Do not attempt to modify or fix this unit. Contact qualified Yamaha service personnel when any service is needed. The cabinet should never be opened for any reasons.
- 15 When not planning to use this unit for long periods of time (i.e. vacation), disconnect the power cable from the wall outlet.
- 16 Install this unit near the wall outlet and where the power cable can be reached easily.
- 17 Be sure to read the “TROUBLESHOOTING” section in this manual on common operating errors before concluding that this unit is faulty.
- 18 Before moving this unit, press POWER to turn off this unit and then disconnect the power cable from the wall outlet.
- 19 The batteries shall not be exposed to excessive heat such as sunshine, fire or like.

20 VOLTAGE SELECTOR (Asia and General models only)

The VOLTAGE SELECTOR on the rear panel of this unit must be set for your local main voltage BEFORE plugging into the wall outlet. Voltages are:

..... AC 110/120/220/230–240 V, 50/60 Hz

As long as this unit is connected to the wall outlet, it is not disconnected from the AC power source even if you turn off this unit by POWER.

WARNING

TO REDUCE THE RISK OF FIRE OR ELECTRIC SHOCK, DO NOT EXPOSE THIS UNIT TO RAIN OR MOISTURE.

LASER SAFETY

This unit employs a laser. Due to possible eye injury, only a qualified service person should remove the cover or attempt to service this device.

DANGER

This unit emits visible laser radiation when open. Avoid direct eye exposure to beam. When this unit is plugged into the wall outlet, do not place your eyes close to the opening of the disc tray and other openings to look into inside.

The laser component in this product is capable of emitting radiation exceeding the limit for Class 1.

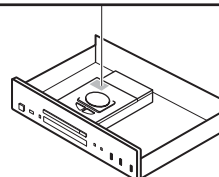

CONTENTS

INTRODUCTION

FEATURES	2
SUPPLIED ACCESSORIES	2
CONTROLS AND FUNCTIONS	3
Front panel.....	3
Front panel display	4
Remote control.....	5
Installing batteries in the remote control	6
Using the remote control	6

PREPARATION

CONNECTIONS	7
Connecting your amplifier.....	7
Connecting the supplied power cable.....	8
Connecting USB devices.....	8

OPERATION

BASIC OPERATION	9
Starting playback	9
Pausing playback	10
Stopping playback	10
Turning off the power.....	10
Playing back a desired track	10
To improve audio quality (PURE DIRECT mode)	10
Skipping to the beginning of a desired track	11
Advancing or reversing playback rapidly.....	11
Changing front panel display.....	12
Changing the brightness of the front panel display	12
RANDOM-SEQUENCE PLAY	13
REPEAT PLAY	13
Repeating a selected item	13
Repeat A-B	14
PROGRAM PLAY	15
Stopping program playback.....	16
Clearing programmed track	16

ADDITIONAL INFORMATION

NOTES ABOUT DISCS/MP3, WMA FILES	17
TROUBLESHOOTING	19
SPECIFICATIONS	20

INTRODUCTION

PREPARATION

OPERATION

ADDITIONAL
INFORMATION

■ About this manual

- ☞ indicates a tip for your operation.
- In this manual, audio CDs are referred to as “Audio CD”, MP3/WMA discs as “Data Disc”, and MP3/WMA files stored on the USB device as “USB”.
- This manual is printed prior to production. Design and specifications are subject to change in part as a result of improvements, etc. In case of differences between the manual and the product, the product has priority.

English

FEATURES

- ◆ Optical Digital Output
- ◆ Coaxial Digital Output
- ◆ CD-R, CD-RW Disc Playability
(For details, refer to page 17.)
- ◆ MP3, WMA Disc Playability
- ◆ MP3, WMA File Playability Stored on USB Device
- ◆ Program Play (Audio CD only)
- ◆ Random-Sequence Play
- ◆ Single Track/Entire Disc Repeat Play
- ◆ Repeat A-B Play (Audio CD only)
- ◆ Adjustable Display Information and Brightness
- ◆ PURE DIRECT Function

SUPPLIED ACCESSORIES

Please check that you received all of the following parts:

Remote control

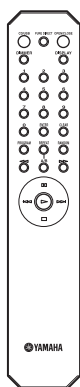

RCA stereo cable

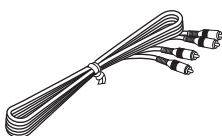

Power cable

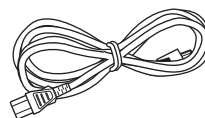

**Batteries (x 2)
(AA, R6, UM-3)**

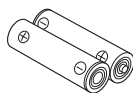

CONTROLS AND FUNCTIONS

Front panel

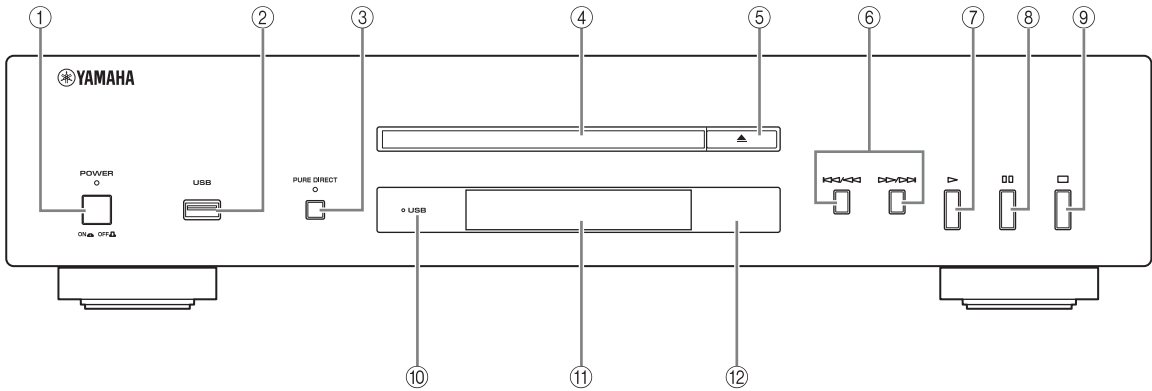

① POWER

Press to turn the power to ON/OFF.



The POWER indicator above lights up when this unit is turned on.

② USB port

Connect your USB device. See page 8 for details.

③ PURE DIRECT

Turn PURE DIRECT mode on or off to improve audio quality.



The PURE DIRECT indicator above lights up when this unit is in PURE DIRECT mode. See page 10 for details.



④ Disc tray



Load a disc.



⑤ (Open/Close)





Open or close the disc tray.

⑥ / (Skip/Search backward), / (Skip/Search forward)





 / : Skip to the next track.

 / : Skip back to the beginning of the current track.

 /  (twice): Skip to the previous track.

Press and hold  /  or  /  to search backward/ forward.





Each time you press and hold  /  or  / , the search speed increases by 2 levels.

⑦ (Play)

Start playback.

⑧ (Pause)

Pause playback. Press  or  to resume playback.

⑨ (Stop)

Stop playback.

⑩ USB indicator

Lights on/off when this unit is in USB/disc mode, and blinks when this unit is reading the USB device.

⑪ Front panel display

Shows the current status of this unit.

⑫ Remote control sensor

Receives signals from the remote control.

Front panel display

Audio CD

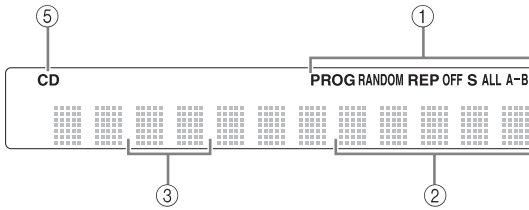

- ① Lights up the icon for the selected playback mode.
- ② Shows the time displays. (Refer to page 12.)
- ③ Shows the track number selected or being played back.
- ④ Shows the file number.
- ⑤ Lights up when this unit is in disc mode (refer to page 9) and also when an Audio CD is recognized on the tray.
- ⑥ Lights up when MP3 file is played back.
- ⑦ Lights up when WMA file is played back.

Data Disc USB

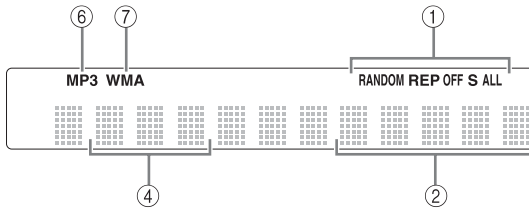

Remote control

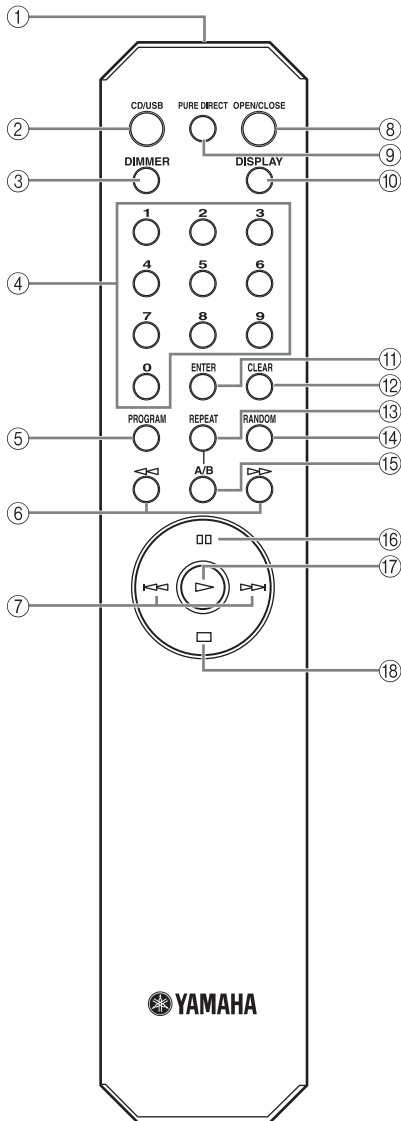

- ① **Infrared signal transmitter (p. 6)**
Send infrared signals to this unit.
- ② **CD/USB (p. 9)**
Switch between disc mode and USB mode.
- ③ **DIMMER (p. 12)**
Select brightness level for the front panel display.
- ④ **Numeric buttons (p. 10)**
Select a track directly.
- ⑤ **PROGRAM (p. 15)**
Turn program mode on or off.
- ⑥ **◀◀/▶▶ (Search backward/forward) (p. 11)**
Search tracks backward/forward.
- ⑦ **◀◀/▶▶ (Skip backward/forward) (p. 11)**
Skip to the next/previous track or skip back to the beginning of the current track.
- ⑧ **OPEN/CLOSE (p. 9)**
Open or close the disc tray.
- ⑨ **PURE DIRECT (p. 10)**
Turn PURE DIRECT mode on or off.
- ⑩ **DISPLAY (p. 12)**
Switch the time display.
- ⑪ **ENTER (p. 15)**
Confirm the track number when this unit is in program input mode.
- ⑫ **CLEAR (p. 16)**
Clear programmed track.
- ⑬ **REPEAT (p. 13)**
Repeat playback of a single track or all tracks.
- ⑭ **RANDOM (p. 13)**
Set random-sequence play.
- ⑮ **A/B (p. 14)**
Set repeat A-B.
- ⑯ **⏸ (Pause) (p. 10)**
Pause playback.
- ⑰ **▶ (Play) (p. 9)**
Start playback.
- ⑱ **◻ (Stop) (p. 10)**
Stop playback.

Installing batteries in the remote control

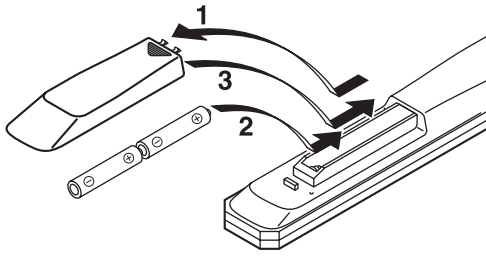

- 1** Press the ▼ part and slide the battery compartment cover off.
- 2** Insert two supplied batteries (AA, R6, UM-3) according to the polarity markings (+ and -) on the inside of the battery compartment.
- 3** Slide the cover back until it snaps into place.

■ Notes on batteries

- Change both batteries when the operation range of the remote control decreases.
- Use AA, R6, UM-3 batteries.
- Make sure that the polarities are correct. See the illustration inside the battery compartment.
- Remove the batteries if the remote control is not to be used for an extended period of time.
- Do not use old batteries together with new ones.
- Do not use different types of batteries (such as alkaline and manganese batteries) together. Read the packaging carefully as these different types of batteries may have the same shape and color.
- If the batteries have leaked, dispose of them immediately. Avoid touching the leaked material or letting it come into contact with clothing, etc. Clean the battery compartment thoroughly before installing new batteries.
- Do not throw away batteries with general house waste; dispose of them correctly in accordance with your local regulations.

Using the remote control

The remote control transmits a directional infrared beam. Be sure to aim the remote control directly at the remote control sensor on the front panel of this unit during operation.

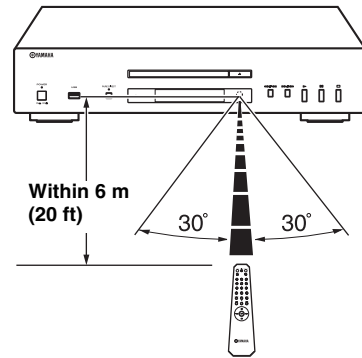

■ Handling the remote control

- The area between the remote control and this unit must be clear of large obstacles.
- Do not spill water or other liquids on the remote control.
- Do not drop the remote control.
- Do not leave or store the remote control in the following types of conditions:
 - high humidity, such as near a bath
 - high temperature, such as near a heater or a stove
 - extremely low temperatures
 - dusty places
- Do not expose the remote control sensor to strong lighting, in particular, an inverter type fluorescent lamp; otherwise, the remote control may not work properly. If necessary, position the unit away from direct lighting.

CONNECTIONS

Connecting your amplifier

CAUTION

- Before making any connection, switch OFF the power to the unit, the amplifier and any other component.
- Connections should be made to the correct input terminals of the amplifier or another component.
- If the placement of this unit causes noise to another equipment, such as a tuner, move them further away from each other.

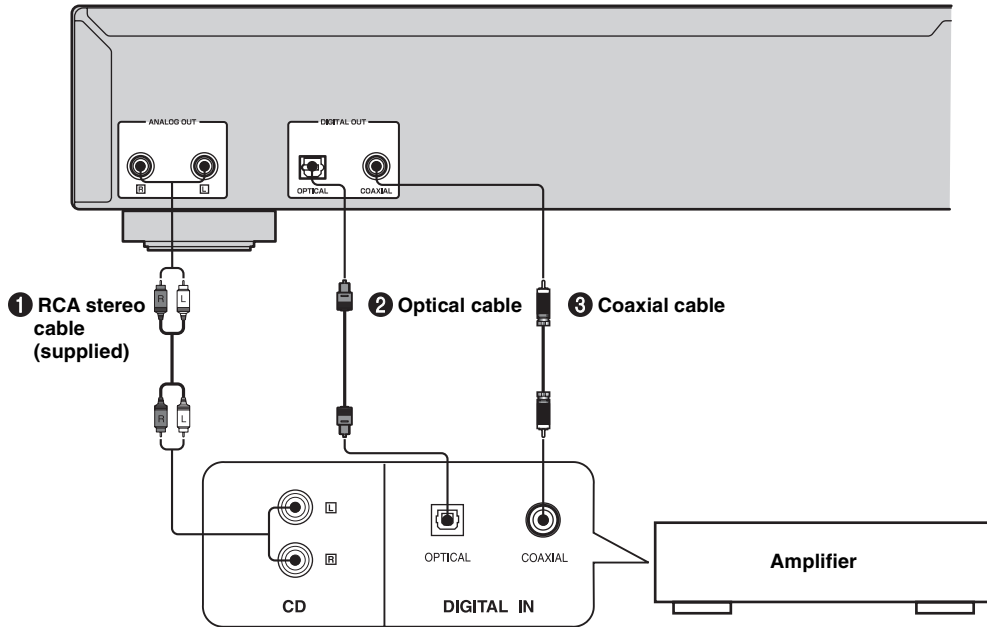

- The digital output is turned off when this unit is in PURE DIRECT mode.

To connect this unit to your amplifier, choose one of the ways listed below.

When the ANALOG OUT terminals of this unit are used (①)

Connect these terminals to the CD (or AUX) terminals of the amplifier by using a supplied RCA stereo cable. For details concerning these connections, refer to the operation instructions of the amplifier being used.

- Be sure that the left (L) and right (R) of these terminals are connected to the corresponding (left and right) terminals of the amplifier or other component.

When the DIGITAL OUT (OPTICAL) terminal of this unit is used (②)

Connect this terminal to the optical input terminal of an amplifier with a commercially available optical cable.

- Use a reliable optical cable.

When the DIGITAL OUT (COAXIAL) terminal of this unit is used (③)

Connect this terminal to the digital input terminal of an amplifier with a commercially available coaxial cable.

Connecting the supplied power cable

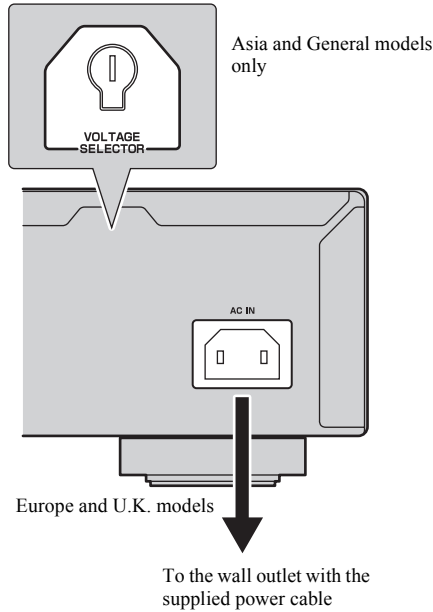

■ VOLTAGE SELECTOR (Asia and General models only)

The VOLTAGE SELECTOR on the rear panel of this unit must be set for your local main voltage BEFORE plugging the supplied power cable into the wall outlet. Improper setting of the VOLTAGE SELECTOR may cause damage to this unit and create a potential fire hazard.

Rotate the VOLTAGE SELECTOR clockwise or counterclockwise to the correct position using a straight slot screwdriver.

Voltages are as follows:

..... AC 110/120/220/230-240 V, 50/60 Hz

■ Connecting this unit to the wall outlet

Plug the supplied power cable into the AC IN on the rear panel of this unit and then plug the power cable into the wall outlet after all other connections are complete.

Connecting USB devices

This unit has a USB port and can access MP3 or WMA files saved on your USB device. Connect your USB device to the USB port on the front panel of this unit.

CAUTION

Do not disconnect your USB device while playing back from the USB device, or when the USB indicator blinks.

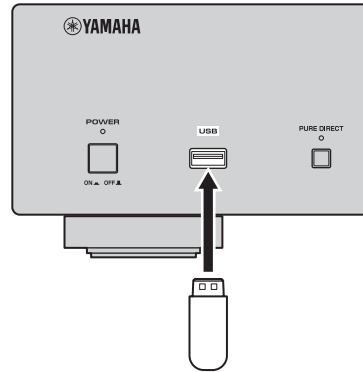

■ Supported USB devices

This unit supports USB mass storage class devices (e.g., flash memories, card readers or portable audio players) that use FAT16 or FAT32 format.

Notes

- Some devices may not work properly even if they meet the requirements.
- Do not connect devices other than USB mass storage class devices: USB chargers, USB hubs, PCs, external HDD, etc.
- When you insert two or more memory cards at the same time into a card reader connected to the USB port on this unit, only one of the memory cards is recognized.
- Yamaha and suppliers accept no liability for the loss of data saved on the USB devices connected to this unit. As a precaution, it is recommended that the files are made backup copies.
- Playability of and power supply to all kind of USB devices are not guaranteed.

This manual describes how to operate this unit by using the remote control. To operate this unit from the front panel, use the corresponding buttons on the front panel. The **Audio CD**, **Data Disc** and **USB** icons indicate music data formats that can be used in the operation.

BASIC OPERATION

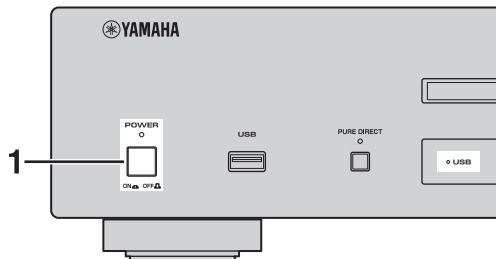

1 Press POWER to turn on the power.

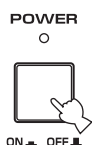

2 Press CD/USB to switch between disc mode and USB mode.



When USB mode is selected, the USB indicator lights up, and when disc mode is selected, the USB indicator lights off.

This setting is retained even if you turn off this unit.

Starting playback

■ Playing back discs

Audio CD **Data Disc**

1 Press OPEN/CLOSE to open the disc tray, and load a disc.

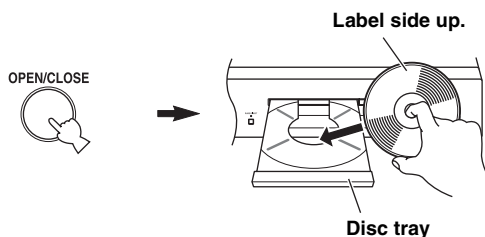

Notes

- When you load a disc, set the disc on the inside of the disc guides (4 marks on the disc tray).
- The disc may not be read correctly, if it is set incorrectly. In this case, open the disc tray and set the disc again.

2 Press OPEN/CLOSE to close the disc tray.



You can also close the disc tray by pressing \triangleright , a numeric button, or by pressing the front edge of the disc tray gently. If the tray is closed in one of these ways, playback starts automatically.

3 Press \triangleright to start playback.

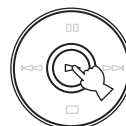

For an Audio CD, playback starts from the first track, and for a Data Disc, in alphanumeric order by filename.

Display information in step 2

Audio CD

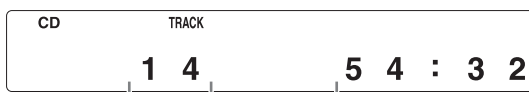

Total number of tracks Total recorded time of a disc

Data Disc



Total number of files

■ Playing back USB devices

USB

Connect your USB device to the USB port on the front panel. (For details, refer to page 8.)

When USB mode is selected (USB indicator lights up), first filename is displayed in the front panel display (refer to page 12), and playback starts automatically in order by date and time of creation if playable files are in the USB device.

To disconnect USB devices

Press  to stop playback, and then disconnect the USB device.

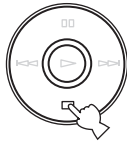

Note



Do not disconnect your USB device while playing back from the USB device, or when the USB indicator blinks.

Pausing playback

Audio CD Data Disc USB

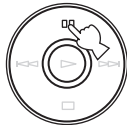
Press .





To resume playback, press  again (or press .

Stopping playback

Audio CD Data Disc USB

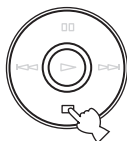
Press .



If you press  again, playback starts from the first track.

Turning off the power

Press POWER again.

If you turn off the power when disc mode is selected, the next time you turn the power on, playback starts automatically of the disc on the tray. If you turn off the power when USB mode is selected, playback will start automatically of the USB device connected.

Playing back a desired track

Audio CD

Select a desired track by using the numeric buttons.

Example: To select track number 12
Press “1”, and then press “2”.



Following information is displayed.

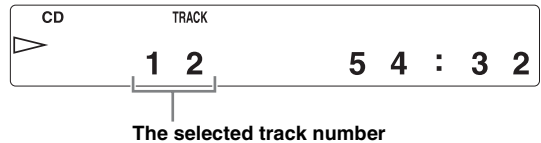

Playback starts in 2 seconds.

Note

This operation is not available for Data Disc and USB.



You can also select and playback a desired track during playback.

To improve audio quality (PURE DIRECT mode)

Audio CD Data Disc USB

Press PURE DIRECT.



This unit is set to PURE DIRECT mode.

- The PURE DIRECT indicator lights up.
- The digital output is turned off.
- The front panel display is turned off and only the minimum required indicators and messages are displayed during playback.

Note

Connect using the ANALOG OUT terminals when you use PURE DIRECT mode (refer to page 7).



- Press **PURE DIRECT** again to turn off PURE DIRECT mode.
- This setting is retained even if you turn off this unit.

Skipping to the beginning of a desired track

Audio CD

Data Disc

USB

To play back from the beginning of the next track, press **▶▶** once.

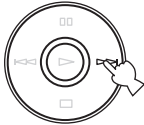

To play back from the beginning of the current track, press **◀◀** once.



To play back from the beginning of the previous track, press **◀◀** twice.



- These operations can also be performed for Data Disc/USB.
- These operations can also be performed when the unit is paused.
- These operations can also be performed using **◀◀◀◀/◀◀◀◀** and **▶▶▶▶/▶▶▶▶** on the front panel.

Advancing or reversing playback rapidly

Audio CD

Data Disc

USB

To advance rapidly, press **▶▶▶▶** once during playback.



To reverse rapidly, press **◀◀◀◀** once during playback.



To resume playback, press **▶** at the desired point.

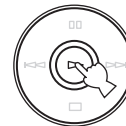

- These operations can also be performed for Data Disc/USB.
- The sound can be heard (although slightly garbled) during these operation in either direction. This is convenient for locating a precise position within a track, or for reviewing the contents quickly. Sound may not be heard depending on the MP3/WMA file.
- Each time you press **◀◀◀◀** or **▶▶▶▶**, the search speed increases by 2 levels.
- These operations can also be performed pressing and holding **◀◀◀◀/◀◀◀◀** or **▶▶▶▶/▶▶▶▶** on the front panel for more than 2 seconds.

Changing front panel display

■ When playing back an Audio CD

Audio CD

You can select the following front panel displays (① - ③) by pressing **DISPLAY**.

① Elapsed time of the current track (Default)



② Remaining time of the current track

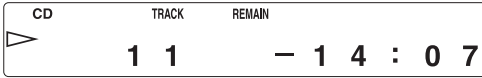

③ Remaining time of the disc

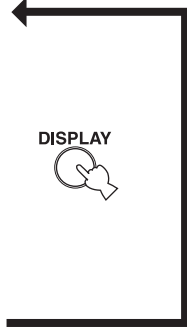
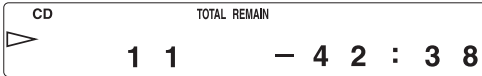

■ When playing back a Data Disc or USB device

Data Disc

USB

You can temporarily display the filename by pressing **DISPLAY**.

These front panel display examples are for an MP3 file.

① Elapsed time of the current track



② Filename*



Returns to the normal display after displaying a filename.

* 28 characters maximum

Note

This unit can only show alphanumeric characters.

Changing the brightness of the front panel display

Press **DIMMER** to change the brightness level for the front panel display.



Each time you press **DIMMER**, the brightness level changes in the following order:
Max (brightest) → Level1 (default) → Level2 → Level3 (darkest) → Max

Notes

- Brightness is slightly decreased during playback, except when the level is set to maximum.
- Brightness may temporarily be decreased for some operations, except when the level is set to maximum.
- This setting is retained even if you turn off this unit.

RANDOM-SEQUENCE PLAY

Audio CD

Data Disc

USB

You can play back the tracks in random sequence.

Note

These operations can also be performed for Data Disc/USB.

To perform random-sequence play

Press , and then, **RANDOM**.

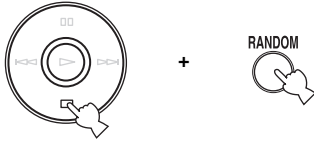

To cancel random-sequence play

Press .

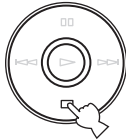

REPEAT PLAY

Repeating a selected item

Audio CD

Data Disc

USB

You can play back a single track or all tracks repeatedly by pressing **REPEAT** during playback. The repeat playback mode changes each time you press **REPEAT**.

S (Single repeat)

A single track is played back repeatedly.

ALL (Full repeat)

All tracks (the entire disc) are played back repeatedly.

Note

These operations can also be performed for Data Disc/USB.



Repeat play also works for program play and random-sequence play.

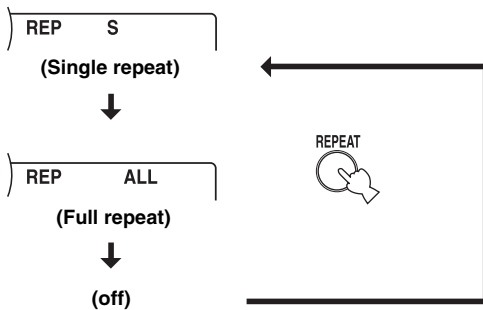

Repeat A-B

Audio CD

You can repeat a specified section of a track by pressing **A/B** during playback to set two points (start and end points).

1 Press **A/B** to select the start point of repeat play.

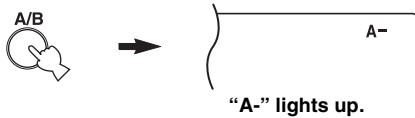

2 Press **A/B** to select the end point of repeat play.

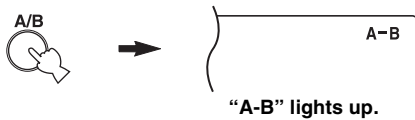

The selected section is played back repeatedly.

To cancel repeat A-B

Press **A/B** again to make "A-B" disappear from the front panel display.

Notes

- You cannot set repeat A-B from one track to another track.
- This operation is not available for Data Disc and USB.
- If you stop playback by pressing \square , repeat A-B is canceled.
- You cannot use repeat A-B when this unit is in PURE DIRECT mode.

PROGRAM PLAY

Audio CD

You can customize the playback order of up to 50 tracks stored on an Audio CD. This operation is not available for Data Disc and USB.

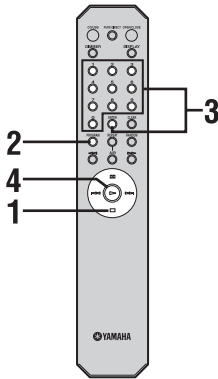

1 Press to stop playback.

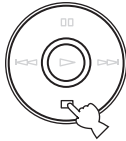

2 Press **PROGRAM**.



- In this mode, the front panel display shows as normally, even when this unit is in PURE DIRECT mode.

This unit is set to program input mode.

3 Program a desired track by pressing the corresponding numeric button and **ENTER**.



+



Following information is displayed.
When you press “6”:



The selected track number

When you press **ENTER**:



Total number of tracks currently programmed

Total time of the tracks currently programmed

Repeat this operation to program more tracks.
You can select the same track again.

Note

Pressing **PROGRAM** in program input mode exits to normal playback mode, though programmed tracks are stored.

4 Press to start program play.



Following information is displayed.





Current track

Elapsed time of the current track

Stopping program playback

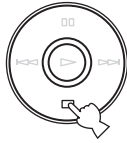
Press .



To restart program play, press  after pressing **PROGRAM**.

Playback starts from the first programmed track number.

Clearing programmed track

There are several methods, as described below.

- Clearing the last programmed track**
 Press **CLEAR** during program input mode.



Following information is displayed.

CD	PROG
P 0 5	0 1 8 : 5 4
Total number of the tracks currently programmed	Total time of the tracks currently programmed

The last programmed track is cleared.

- Clearing all programmed tracks**
 Press **CLEAR** after exiting program input mode.



Following information is displayed.

CD
P G M C L E A R

All programmed tracks are cleared.
 The display is turned off after 2 seconds.

Note

Switching to USB mode, opening the disc tray or switching off the **POWER** clears all programmed tracks.

NOTES ABOUT DISCS/MP3, WMA FILES

■ Discs playable with this unit

Audio CD Data Disc

This player is designed for playing back compact discs bearing the marks shown below. Never attempt to load any other type of disc into the unit. The unit can also play back 8-cm (3-inch) compact discs.



.... **Compact discs (digital audio)**
The most popular discs for commercially available audio CDs.



.... **CD-R, CD-RW digital audio discs**
Music CDs made by copying onto a CD-R or CD-RW (including MP3 or WMA format files).



Notes

- Be sure to use a CD-R or CD-RW disc made by a reliable manufacturer.
- Be sure to use a CD-R or CD-RW disc which has at least one of the following phrases on the disc or disc case.
FOR CONSUMER USE
FOR CONSUMER USE
FOR MUSIC USE ONLY
- Be sure to use a finalized CD-R or CD-RW disc.



.... **CD-TEXT discs**
The discs recorded with text data such as album titles, track titles and artist names. Though these discs can be played back with ordinary CD players, the text data is not displayed.

Note

This compact disc player may not be able to play back some CD-RW discs or discs on which recording was not made correctly.

To prevent a malfunction of this unit:

- Do not use any nonstandard shaped disc (heart, etc.) available on the market because it might damage the unit.
- Do not use a disc with tape, stickers, or paste on it. If you use such a disc, the disc may get stuck in the unit, or damage to the unit may result.



■ About MP3 and WMA files

Data Disc USB

You can play back MP3 and WMA files recorded on a CD-R/CD-RW and those stored on a USB device.

MP3

MP3 is a standard technology and format for compressing an audio sequence into a small-sized file. However, the original level of sound quality is preserved during playback.

The playable formats are:

- MPEG-1 Audio Layer-3
Bitrate*: 32-320 kbps
Sampling frequency: 44.1/48/32 kHz
- MPEG-2 Audio Layer-3, 2
Bitrate*: 8-160 kbps
Sampling frequency: 24/22.05/16 kHz
- MPEG-2.5 Audio Layer-2
Bitrate*: 8-160 kbps
Sampling frequency: 12/11.025/8 kHz

* Variable bitrate is supported.

WMA

“WMA (Windows Media Audio)” is a Microsoft file format for encoding digital audio files similar to MP3 though can compress files at a higher rate than MP3.

The playable formats are:

- Version 8
- Version 9 (Standard and variable bitrates are supported. Professional and Lossless are not supported.)
- High Profile
Bitrate*: 32-320 kbps
Sampling frequency: 48/44.1/32 kHz
- Mid Profile
Bitrate: 16-32 kbps
Sampling frequency: 22.05/16 kHz

* Both constant and variable bitrates are supported.

Notes

- Playback for Data Disc starts in alphanumeric order.
- Playback for USB starts in order by date and time of creation.
- Copyright-protected WMA (DRM) files cannot be played back by this unit.
- The disc must be ISO9660 compatible.
- Text data contained in files is not displayed on this unit.
- The maximum file and folder numbers are as follows.

	Data Disc	USB
Maximum file number	512	999
Maximum folder number	255	255
Maximum file number per folder	511	255

■ Notes about handling compact discs

- Always handle a disc with care so that its surface is not scratched.

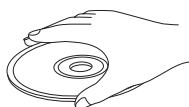

- Compact discs are not subjected to wear during playback, but damage to the disc surface when the disc is being handled can adversely affect the disc playback.
- Be sure to use a felt-tip pen or similar writing tool when writing on the label side of the disc. Do not use a ballpoint pen, pencil, or other hard-tipped writing tool, as these may damage the disc and may adversely affect the disc playback.
- Do not warp discs.
- When a disc is not being used, remove it from the unit and store in an appropriate case.
- When removing or storing a disc, be careful not to scratch the playing surface.
- Compact discs are not affected by small particles of dust or fingerprints on their playing surface, but even so they should be kept clean. Wipe by using a clean, dry cloth.

Do not wipe with a circular motion; wipe straight outward from the center.

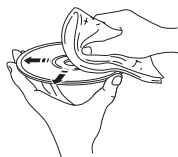

- Do not try to clean the disc's surface by using any type of disc cleaner, record spray, anti-static spray or liquid, or any other chemical-based liquid because such substances might irreparably damage the disc's surface.
- Do not expose discs to direct sunlight, high temperature or high humidity for a long period of time, as these might warp or otherwise damage the disc.



To play back an 8-cm (3-inch) CD

Place it in the inner recessed area of the disc tray. Do not put a normal (12-cm) CD on top of an 8-cm (3-inch) CD.

TROUBLESHOOTING

If the unit fails to operate normally, check the following points to determine whether the problem can be corrected by the simple measures suggested. If it cannot be corrected, or if the problem is not listed in the Problems column, disconnect the power cable and contact your authorized Yamaha dealer or service center for help.

Problems	Possible Causes	Solutions	Refer to page
This unit fails to turn on.	The power cable is not connected to the AC IN inlet on the rear panel or not plugged in the wall outlet.	Connect the power cable firmly.	8
The disc tray does not close completely.	A foreign object is obstructing the tray.	Carefully check the disc tray and remove the foreign object.	—
Disc playback does not start.	The disc is damaged.	Check the disc carefully; replace it if necessary.	—
	There is moisture on the laser pickup.	Wait 20 to 30 minutes after switching on the unit ON before trying to play back a disc.	—
	The disc is loaded upside down.	Reload the disc with the label side up.	9
	The disc is dirty.	Clean the disc.	18
	The format of the MP3 or WMA file is not compatible with this unit.	Replace the disc with a correctly recorded disc playable with this unit.	17
	The CD-RW (ReWritable) disc is not recorded correctly.	Replace the disc with a correctly recorded disc playable with this unit.	17
	The disc is a non-standard disc not playable with this unit.	Replace the disc with a correctly recorded disc playable with this unit.	17
	This unit is in USB mode.	Switch to disc mode by pressing CD/USB .	5, 9
USB playback does not start.	Improper USB device connections.	Connect the USB device again.	8
	The format of the MP3 or WMA file is not compatible with this unit.	Replace the file with a correctly recorded file playable with this unit.	17
	This unit is in disc mode.	Switch to USB mode by pressing CD/USB .	5, 9
Playback is delayed, or begins at the wrong place.	The disc may be scratched or damaged.	Check the disc carefully; replace it if necessary.	18
No sound.	Improper output cable connections.	Connect the cables properly. If the problem persists, the cables may be defective.	7
	Improper amplifier operation.	Set the amplifier controls to the correct input selection.	—
Sound of a component connected to the DIGITAL OUT jacks is not played.	PURE DIRECT is turned on.	Turn PURE DIRECT off. Or make an analog connection.	10
Sound “skips”.	This unit is being subjected to vibrations or impacts.	Relocate this unit.	—
	The disc is dirty.	Clean the disc.	18
Sound “hums”.	Improper cable connections.	Securely connect the audio cables. If the problem persists, the cables may be defective.	7
Noise from a nearby tuner.	The tuner is too close to this unit.	Move the tuner and this unit farther apart.	—
Noise from inside of the disc tray.	The disc may be warped.	Replace the disc.	—

Problems	Possible Causes	Solutions	Refer to page
The remote control does not work or function properly.	Wrong distance or angle.	The remote control functions within a maximum range of 6 m (20 ft) and no more than 30 degrees off-axis from the front panel.	6
	Direct sunlight or lighting (from an inverter type of fluorescent lamp, etc.) is striking the remote control sensor of this unit.	Reposition this unit.	—
	The batteries are weak.	Replace all batteries.	6

SPECIFICATIONS

Audio Section

- Frequency response 2 Hz - 20 kHz, ± 0.5 dB
- Harmonic distortion + noise (1 kHz) 0.002 % or less
- S/N ratio 110 dB or more
- Dynamic 100 dB or more
- Output voltage (1 kHz, 0 dB)..... 2.0 ± 0.3 V

Laser Diode Properties

- Material GaAlAs
- Wavelength 790 nm
- Laser Output..... max. 1.23 μW*

* This output is the value measured at a distance of about 200 mm from the objective lens surface on the Optical Pick-up Block.

General

- Power requirements
 - U.S.A. and Canada models.....AC 120 V, 60 Hz
 - Australia model AC 240 V, 50 Hz
 - Europe and U.K. models AC 220-240 V, 50 Hz
 - Asia and General modelsAC 110-120/220-240 V, 50/60 Hz
 - Korea modelAC 220 V, 60 Hz
 - China model.....AC 220 V, 50 Hz
- Power consumption 16 W
- Dimensions (W × H × D) 435 × 96 × 300 mm
- Weight 6.2 kg

Please note that all specifications are subject to change without notice.

Limited Guarantee for European Economic Area (EEA) and Switzerland

Thank you for having chosen a Yamaha product. In the unlikely event that your Yamaha product needs guarantee service, please contact the dealer from whom it was purchased. If you experience any difficulty, please contact Yamaha representative office in your country. You can find full details on our website (<http://www.yamaha-hifi.com/> or <http://www.yamaha-uk.com/> for U.K. resident).

The product is guaranteed to be free from defects in workmanship or materials for a period of two years from the date of the original purchase. Yamaha undertakes, subject to the conditions listed below, to have the faulty product or any part(s) repaired, or replaced at Yamaha's discretion, without any charge for parts or labour. Yamaha reserves the right to replace a product with that of a similar kind and/or value and condition, where a model has been discontinued or is considered uneconomic to repair.

Conditions

1. The original invoice or sales receipt (showing date of purchase, product code and dealer's name) MUST accompany the defective product, along with a statement detailing the fault. In the absence of this clear proof of purchase, Yamaha reserves the right to refuse to provide free of charge service and the product may be returned at the customer's expense.
2. The product MUST have been purchased from an AUTHORISED Yamaha dealer within the European Economic Area (EEA) or Switzerland.
3. The product must not have been the subject of any modifications or alterations, unless authorised in writing by Yamaha.
4. The following are excluded from this guarantee:
 - a. Periodic maintenance and repair or replacement of parts due to normal wear and tear.
 - b. Damage resulting from:
 - (1) Repairs performed by the customer himself or by an unauthorised third party.
 - (2) Inadequate packaging or mishandling, when the product is in transit from the customer. Please note that it is the customer's responsibility to ensure the product is adequately packaged when returning the product for repair.
 - (3) Misuse, including but not limited to (a) failure to use the product for its normal purpose or in accordance with Yamaha's instructions on the proper use, maintenance and storage, and (b) installation or use of the product in a manner inconsistent with the technical or safety standards in force in the country where it is used.
 - (4) Accidents, lightning, water, fire, improper ventilation, battery leakage or any cause beyond Yamaha's control.
 - (5) Defects of the system into which this product is incorporated and/or incompatibility with third party products.
 - (6) Use of a product imported into the EEA and/or Switzerland, not by Yamaha, where that product does not conform to the technical or safety standards of the country of use and/or to the standard specification of a product sold by Yamaha in the EEA and/or Switzerland.
 - (7) Non AV (Audio Visual) related products.
(Products subject to "Yamaha AV Guarantee Statement" are defined in our website at <http://www.yamaha-hifi.com/> or <http://www.yamaha-uk.com/> for U.K. resident.)
5. Where the guarantee differs between the country of purchase and the country of use of the product, the guarantee of the country of use shall apply.
6. Yamaha may not be held responsible for any losses or damages, whether direct, consequential or otherwise, save for the repair or replacement of the product.
7. Please backup any custom settings or data, as Yamaha may not be held responsible for any alteration or loss to such settings or data.
8. This guarantee does not affect the consumer's statutory rights under applicable national laws in force or the consumer's rights against the dealer arising from their sales/purchase contract.

■ For U.K. customers

Information for Users on Collection and Disposal of Old Equipment and Used Batteries



These symbols on the products, packaging, and/or accompanying documents mean that used electrical and electronic products and batteries should not be mixed with general household waste.

For proper treatment, recovery and recycling of old products and used batteries, please take them to applicable collection points, in accordance with your national legislation and the Directives 2002/96/EC and 2006/66/EC.



By disposing of these products and batteries correctly, you will help to save valuable resources and prevent any potential negative effects on human health and the environment which could otherwise arise from inappropriate waste handling.



For more information about collection and recycling of old products and batteries, please contact your local municipality, your waste disposal service or the point of sale where you purchased the items.

[Information on Disposal in other Countries outside the European Union]

These symbols are only valid in the European Union. If you wish to discard these items, please contact your local authorities or dealer and ask for the correct method of disposal.



Note for the battery symbol (bottom two symbol examples):

This symbol might be used in combination with a chemical symbol. In this case it complies with the requirement set by the Directive for the chemical involved.

Pb

