

CX-1

CX-2

Natural Sound Stereo Pre-Amplifier

CONTENTS

Safety Instructions	2
Features	3
Supplied Accessories	3
Connections	4
Operations	7
Remote Control Transmitter	11
Specifications	16
Troubleshooting	18

IMPORTANT!

Please record the serial number of this unit in the space below.

Model:
Serial No.:

The serial number is located on the rear of the unit.
Retain this Owner's Manual in a safe place for future reference.



OWNER'S MANUAL

YAMAHA

SAFETY INSTRUCTIONS

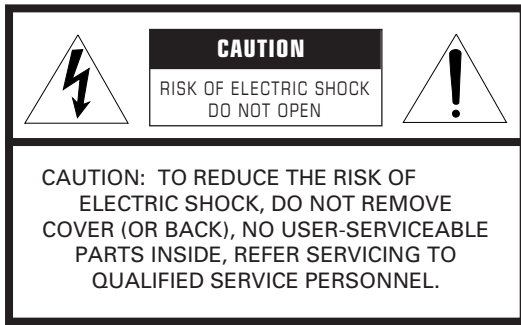

• Explanation of Graphical Symbols

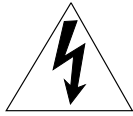

The lightning flash with arrowhead symbol, within an equilateral triangle, is intended to alert you to the presence of uninsulated "dangerous voltage" within the product's enclosure that may be of sufficient magnitude to constitute a risk of electric shock to persons.



The exclamation point within an equilateral triangle is intended to alert you to the presence of important operating and maintenance (servicing) instructions in the literature accompanying the appliance.

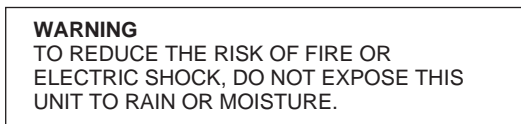

- 1 Read Instructions – All the safety and operating instructions should be read before the unit is operated.
- 2 Retain Instructions – The safety and operating instructions should be retained for future reference.
- 3 Heed Warnings – All warnings on the unit and in the operating instructions should be adhered to.
- 4 Follow Instructions – All operating and other instructions should be followed.
- 5 Water and Moisture – The unit should not be used near water – for example, near a bathtub, washbowl, kitchen sink, laundry tub, in a wet basement, or near a swimming pool, etc.
- 6 Carts and Stands – The unit should be used only with a cart or stand that is recommended by the manufacturer.
- 6A A unit and cart combination should be moved with care. Quick stops, excessive force, and uneven surfaces may cause the unit and cart combination to overturn.



- 7 Wall or Ceiling Mounting – The unit should be mounted to a wall or ceiling only as recommended by the manufacturer.
- 8 Ventilation – The unit should be situated so that its location or position does not interfere with its proper ventilation. For example, the unit should not be situated on a bed, sofa, rug, or similar surface, that may block the ventilation openings; or placed in a built-in installation, such as a bookcase or cabinet that may impede the flow of air through the ventilation openings.
- 9 Heat – The unit should be situated away from heat sources such as radiators, stoves, or other appliances that produce heat.
- 10 Power Sources – The unit should be connected to a power supply only of the type described in the operating instructions or as marked on the unit.
- 11 Power-Cord Protection – Power-supply cords should be routed so that they are not likely to be walked on or pinched by items placed upon or against them, paying particular attention to cords at plugs, convenience receptacles, and the point where they exit from the unit.
- 12 Cleaning – The unit should be cleaned only as recommended by the manufacturer.
- 13 Nonuse Periods – The power cord of the unit should be unplugged from the outlet when left unused for a long period of time.
- 14 Object and Liquid Entry – Care should be taken so that objects do not fall into and liquids are not spilled into the inside of the unit.
- 15 Damage Requiring Service – The unit should be serviced by qualified service personnel when:
 - A. The power-supply cord or the plug has been damaged; or
 - B. Objects have fallen, or liquid has been spilled into the unit; or
 - C. The unit has been exposed to rain; or
 - D. The unit does not appear to operate normally or exhibits a marked change in performance; or
 - E. The unit has been dropped, or the cabinet damaged.
- 16 Servicing – The user should not attempt to service the unit beyond those means described in the operating instructions. All other servicing should be referred to qualified service personnel.
- 17 Power Lines – An outdoor antenna should be located away from power lines.
- 18 Grounding or Polarization – Precautions should be taken so that the grounding or polarization is not defeated.

We Want You Listening For A Lifetime

YAMAHA and the Electronic Industries Association's Consumer Electronics Group want you to get the most out of your equipment by playing it at a safe level. One that lets the sound come through loud and clear without annoying blaring or distortion – and, most importantly, without affecting your sensitive hearing. Since hearing damage from loud sounds is

often undetectable until it is too late, YAMAHA and the Electronic Industries Association's Consumer Electronics Group recommend you to avoid prolonged exposure from excessive volume levels.



Caution: Read this before operating your unit

- 1 To ensure the finest performance, please read this manual carefully. Keep it in a safe place for future reference.
- 2 Install your unit in a cool, dry, clean place – away from windows, heat sources, and too much vibration, dust, moisture or cold. Avoid sources of hum (transformers, motors). To prevent fire or electrical shock, do not expose to rain and water.
- 3 Do not operate the unit upside-down. It may overheat, possibly causing damage.
- 4 Never open the cabinet. If a foreign object drops into the set, contact your dealer.
- 5 Always set the volume control to “– ∞” before starting the audio source play: increase the volume gradually to an appropriate level after the play is started.
- 6 Do not use force on switches, knobs or cords. When moving the set, first turn the unit off. Then gently disconnect the power plug and the cords connecting to other equipment. Never pull the cord itself.
- 7 Do not attempt to clean the unit with chemical solvents; this might damage the finish. Use a clean, dry cloth.
- 8 When not planning to use this unit for long periods of time (ie., vacation, etc.), disconnect the AC power plug from the wall outlet.
- 9 Be sure to read the “Troubleshooting” section on common operating errors before concluding that your unit is faulty.
- 10 Do not connect audio equipment to the AC outlets on the rear panel if that equipment requires more power than the outlets are rated to provide.

FCC INFORMATION

1. IMPORTANT NOTICE : DO NOT MODIFY THIS UNIT!

This product, when installed as indicated in the instructions contained in this manual, meets FCC requirements. Modifications not expressly approved by Yamaha may void your authority, granted by the FCC, to use the product.

2. IMPORTANT : When connecting this product to accessories and/or another product use only high quality shielded cables. Cable/s supplied with this product MUST be used. Follow all installation instructions. Failure to follow instructions could void your FCC authorization to use this product in the USA.

3. NOTE : This product has been tested and found to comply with the requirements listed in FCC Regulations, Part 15 for Class “B” digital devices. Compliance with these requirements provides a reasonable level of assurance that your use of this product in a residential environment will not result in harmful interference with other electronic devices.

This equipment generates/uses radio frequencies and, if not installed and used according to the instructions found in the users manual, may cause interference harmful to the operation of other electronic devices.

Compliance with FCC regulations does not guarantee that interference will not occur in all installations. If this product is found to be the source of interference, which can be determined by turning the unit “OFF” and “ON”, please try to eliminate the problem by using one of the following measures:

Relocate either this product or the device that is being affected by the interference.

Utilize power outlets that are on different branch (circuit breaker or fuse) circuits or install AC line filter/s.

In the case of radio or TV interference, relocate/reorient the antenna. If the antenna lead-in is 300 ohm ribbon lead, change the lead-in to coaxial type cable.

If these corrective measures do not produce satisfactory results, please contact the local retailer authorized to distribute this type of product. If you can not locate the appropriate retailer, please contact Yamaha Electronics Corp., U.S.A. 6660 Orangethorpe Ave, Buena Park, CA 90620.

The above statements apply ONLY to those products distributed by Yamaha Corporation of America or its subsidiaries.

FEATURES

- Continuously Variable Loudness Control <For CX-2 only>
- PURE DIRECT Switch to Reproduce the Purest Source Sound
- SUBSONIC FILTER Switch to Cut Out Undesirable Ultra-Low-Frequency Signals
- PHONO (MM/MC) Selector Switch
- Video Signal Input/Output Capability (Including S Video Connections) <For CX-2 only>
- Remote Control Capability
- REMOTE CONTROL Connector to Make the Power of the Power Amplifier MX-1 or MX-2 Controlled by This Unit

SUPPLIED ACCESSORIES

After unpacking, check that the following parts are contained.

Remote Control Transmitter.

<CX-1>

<CX-2>

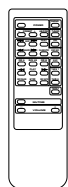

Batteries

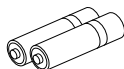

Audio Connection Cord

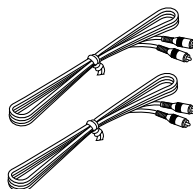

Remote Control Cable

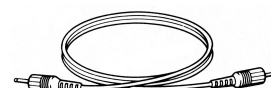

CONNECTIONS

- Before attempting to make any connections to or from this unit, be sure to first switch OFF the power to this unit and to any other components to which connections are being made.
- When making connections between this unit and other components, be sure all connections are made correctly, that is to say L (left) to L, R (right) to R. Also, refer to the owner's manual for each component to be connected to this unit.

<CX-1>

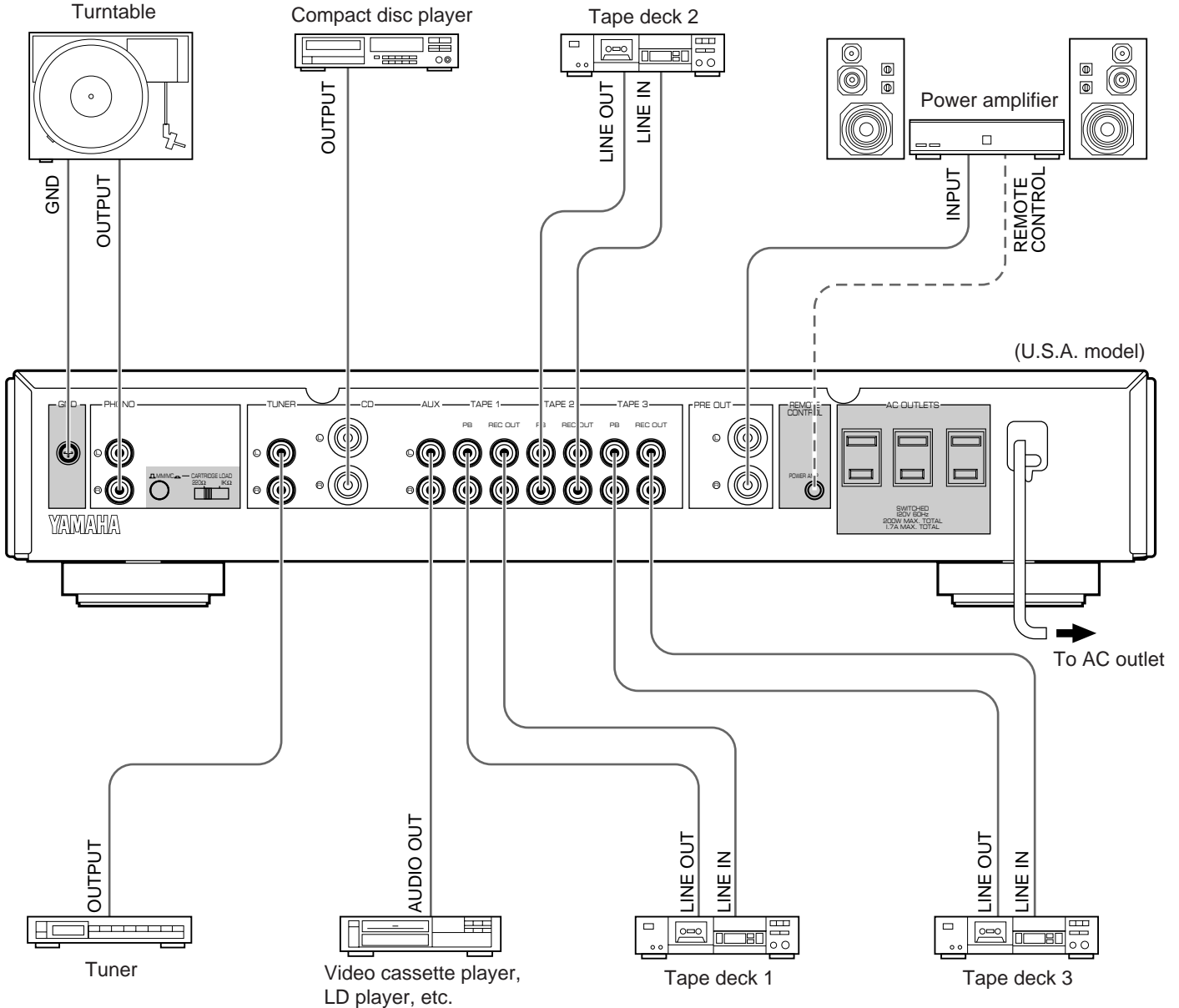

* : Refer to "ABOUT THE ACCESSORY COMPONENTS ON THE REAR PANEL" on page 6.

* The TAPE 3 terminals gain higher Signal-to-Noise Ratio than the TAPE 1 or TAPE 2 terminals. If you will use a Digital Compact Cassette recorder or Minidisc recorder, etc., it is recommended to connect such a component to the TAPE 3 terminals.

<CX-2>

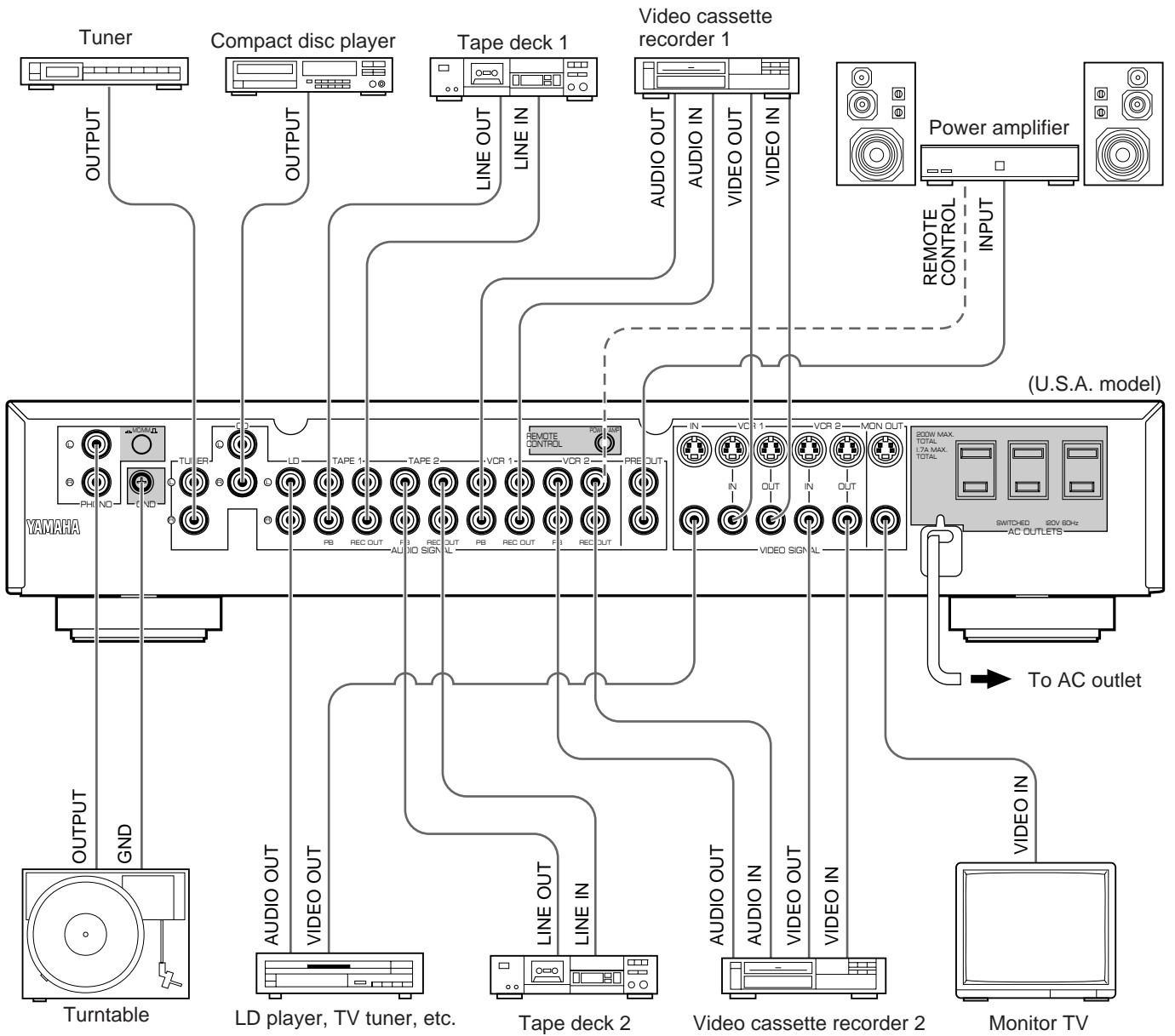

* : Refer to "ABOUT THE ACCESSORY COMPONENTS ON THE REAR PANEL" on page 6.

CONNECTING TO S VIDEO TERMINALS <For CX-2 only>

If your video cassette recorder, LD player, etc. and your monitor are equipped with "S" (high-resolution) video terminals, connect them to this unit's S video terminals, and connect this unit's S MON OUT terminal to the "S" video input of your monitor. Otherwise, connect the composite video terminals from your video cassette recorder, LD player, etc. to the composite video terminals of this unit, and connect this unit's composite MON OUT terminal to the composite video input of your monitor.

Note

If video signals are sent to both S video input and composite video input terminals, the signals will be sent to their respective output terminals independently.

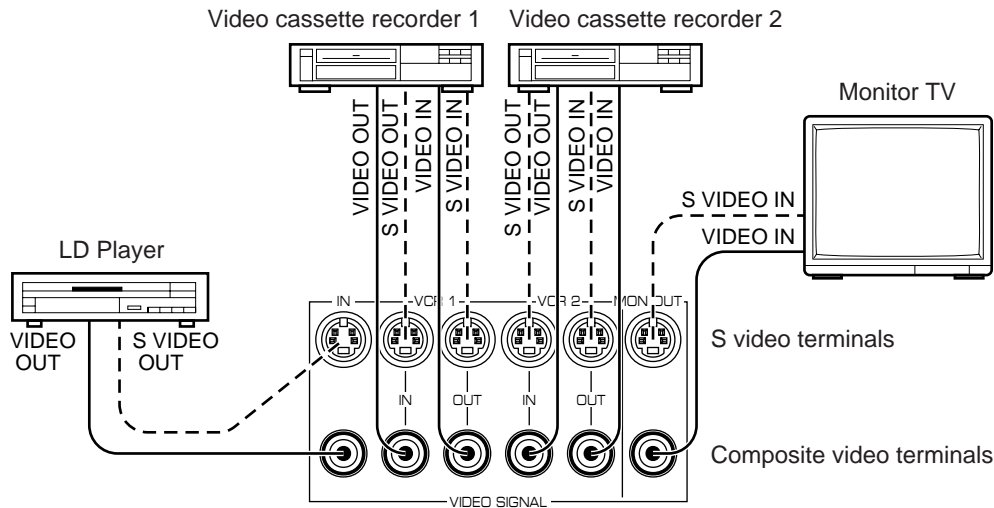

ABOUT THE ACCESSORY COMPONENTS ON THE REAR PANEL

AC OUTLETS (SWITCHED)

(U.S.A., Canada, Europe and General models)3 SWITCHED OUTLETS
(Australia and U.K. models)1 SWITCHED OUTLET

Use these to connect the power cords from your components (except a power amplifier, integrated amplifier and receiver) to this unit.

The maximum power (total power consumption of components) that can be connected to the **SWITCHED AC OUTLETS** is 200 watts. Strictly be careful not to exceed this value.

The power to the **SWITCHED** outlets is controlled by this unit's **POWER** switch or the provided remote control transmitter's **POWER** key. These outlets will supply power to any component whenever this unit is turned on.

PHONO switch

Select either MM or MC position depending on your PHONO cartridge, Moving Magnet or Moving Coil type. However, if you use a high output MC cartridge, select MM position.

CARTRIDGE LOAD switch <For CX-1 only>

Set to either impedance position (220Ω or 1 kΩ) proper for the PHONO MC cartridge being used by your turntable.

GND terminal (For turntable use)

Connecting the ground wire of the turntable to this terminal will normally minimize hum, but in some cases better results may be obtained with the ground wire disconnected.

REMOTE CONTROL (POWER AMP) connector

If you have the YAMAHA power amplifier MX-1 or MX-2, connect this connector to the REMOTE CONTROL (PRE AMP) connector of the power amplifier by using the provided cable. By this connection, the power of the power amplifier is controlled by this unit's **POWER** switch or the provided remote control transmitter's **POWER** key.

After the connection is completed, keep the POWER switch of the power amplifier pressed inward (to the ON position).

Note

If you will not connect the REMOTE CONTROL connectors of this unit and the power amplifier, do not connect the cable to either connector.

OPERATIONS

Illustration: CX-2

The part in shaded area () is not present on CX-1.

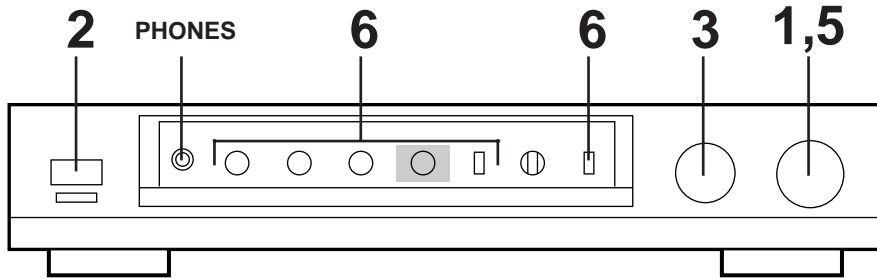

TO PLAY A SOURCE

1

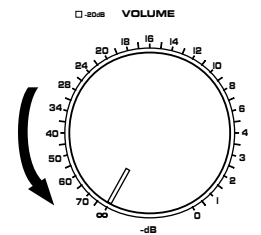

Set to the "∞" position.

2

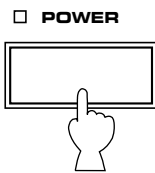

4 Play the source.

5

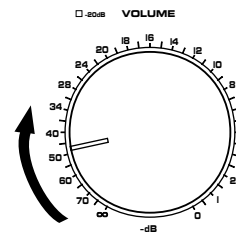

Adjust to the desired output level.

3 Select a desired input source.

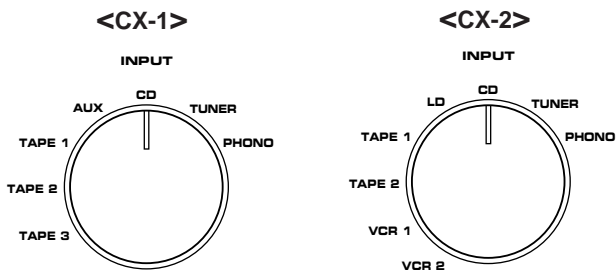

* If you select turntable as an input source (PHONO position), you should confirm that the **PHONO** switch on the rear panel is set to the position corresponding to the type of cartridge being used by the turntable. (Refer to page 6.)

6 If desired, adjust the **LOUDNESS** (for CX-2 only), **BASS**, **TREBLE** and/or **BALANCE** controls, etc. (Refer to page 10.)

Illustration: CX-2

The part in shaded area () is not present on CX-1.

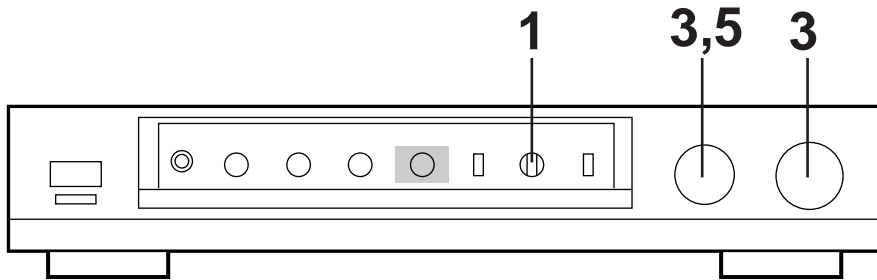

TO RECORD A SOURCE TO TAPE (OR DUB FROM A TAPE TO ANOTHER)

1 Select the source to be recorded.

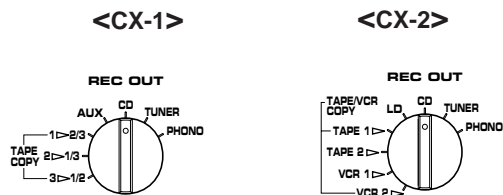

2 Play the source.

3 Confirm the source by selecting it with the **INPUT** selector and turning up the **VOLUME** control.

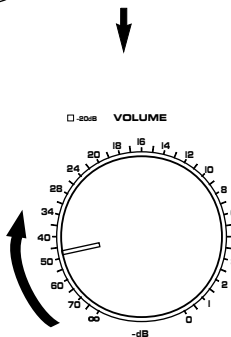
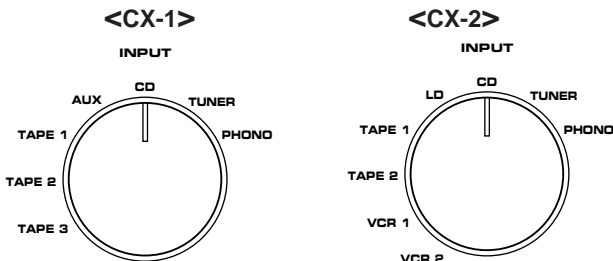

4 Set the tape deck (or VCR) in the recording mode.

5 To monitor the sound (and/or picture) being recorded, select the tape deck (or VCR) being used for recording with the **INPUT** selector.

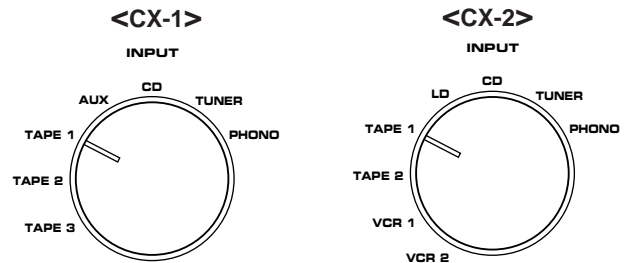

Notes

- If you want to enjoy another source while recording, select it with the **INPUT** selector.
- **LOUDNESS** (for CX-2 only), **BASS**, **TREBLE**, **BALANCE**, **VOLUME** controls and **PURE DIRECT** switch settings have no effect on the material being recorded.

REC OUT selector setting on tape dubbing

<CX-1>

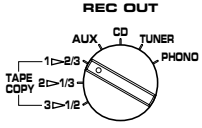
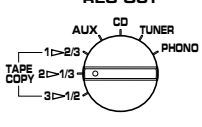
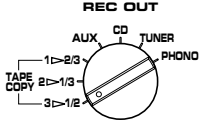
<p>To dub from tape deck 1 to tape deck 2 or 3 (or both tape deck 2 and 3 at the same time)</p>	
<p>To dub from tape deck 2 to tape deck 1 or 3 (or both tape deck 1 and 3 at the same time)</p>	
<p>To dub from tape deck 3 to tape deck 1 or 2 (or both tape deck 1 and 2 at the same time)</p>	

<CX-2>

Source signals from the tape deck or VCR selected by the **REC OUT** selector are dubbed to any other tape deck or VCR.

* When dubbing from a VCR to a tape deck, only audio signals from the VCR are dubbed to the tape deck.

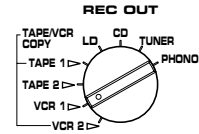

OPEN/CLOSE THE CONTROL DOOR

When it is not necessary to operate controls inside the control door, close the door.

To close the door

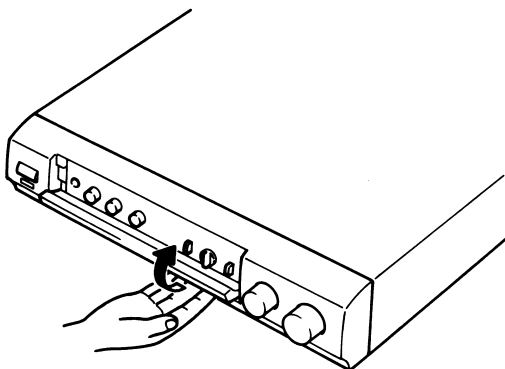

To open the door

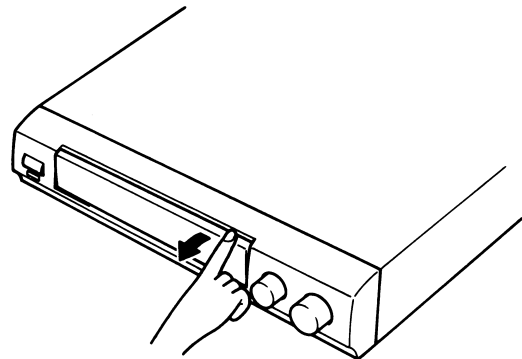

Adjusting the BALANCE control

Adjust the balance of the output volume to the left and right speakers to compensate for sound imbalance caused from speaker location or listening room conditions.



Adjusting the continuously variable LOUDNESS control <For CX-2 only>

This control provides compensation for the human ears' loss of sensitivity to high and low-frequency ranges at low volume. This control is adjustable to retain full tonal range at any volume level.

1

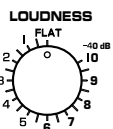

Set to the "FLAT" position.

2

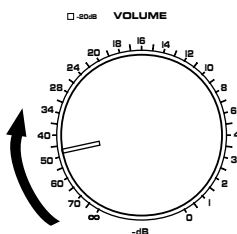

Set to the loudest listening level that you would listen to.

3

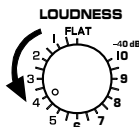

Turn so that the desired volume can be achieved.

Adjusting the BASS and TREBLE controls

BASS : Turn this clockwise to increase (or counter-clockwise to decrease) the low frequency response.

TREBLE : Turn this clockwise to increase (or counter-clockwise to decrease) the high frequency response.

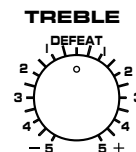

Using the PURE DIRECT switch

You can enjoy the purest possible sound from your audio sources by setting this switch so that the indicator above the **INPUT** selector on the front panel illuminates. By doing so, the audio signal bypasses the **LOUDNESS** (for CX-2 only), **BASS**, **TREBLE**, and **BALANCE** controls, eliminating any alterations to the audio signal.

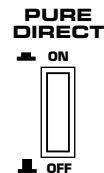

Setting the SUBSONIC FILTER switch

If you set this switch to "ON" position, undesirable ultra-low-frequency signals caused by turntable rumble or warped records can be cut out without losing sound quality.

* This switch will function only when the **INPUT** selector is set to the "PHONO" position.



When you listen with headphones

When listening with headphones privately, connect the headphones to the **PHONES** jack. Sounds from the speakers are cut off.

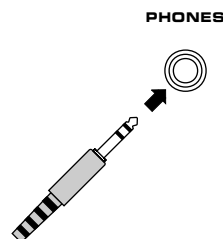

REMOTE CONTROL TRANSMITTER

NOTES ABOUT THE REMOTE CONTROL TRANSMITTER

Battery installation

<CX-1>

<CX-2>

(Australia, U.K. and Europe models)

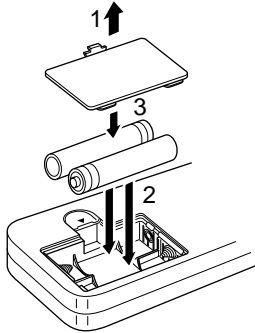

<CX-2>

(U.S.A., Canada and General models)

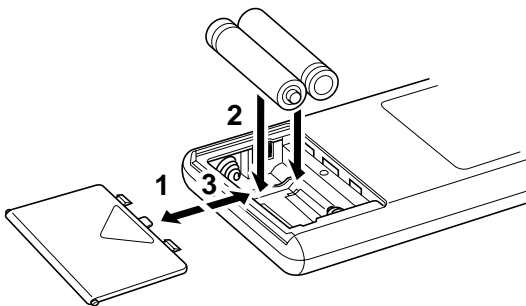

Battery replacement

If you find that the remote control transmitter must be used closer to the main unit, the batteries are weak. Replace both batteries with new ones.

Notes

- Use only AA, R6, UM-3 batteries for replacement.
- Be sure the polarities are correct. (See the illustration inside the battery compartment.)
- Remove the batteries if the remote control transmitter will not be used for an extended period of time.
- If batteries leak, dispose of them immediately. Avoid touching the leaked material or letting it come in contact with clothing, etc. Clean the battery compartment thoroughly before installing new batteries.

Remote control transmitter operation range

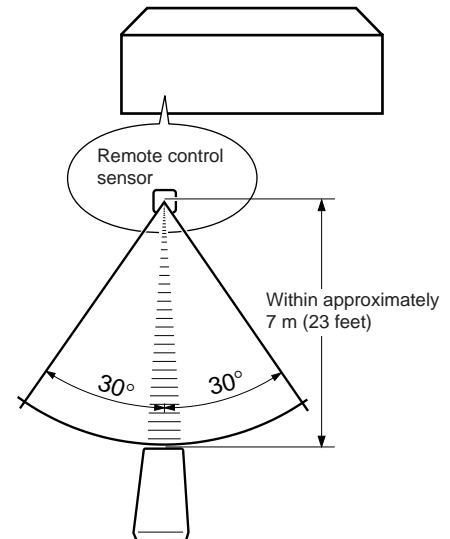

Notes

- There should be no large obstacles between the remote control transmitter and the main unit.
- If the remote control sensor is directly illuminated by strong lighting (especially an inverter type of fluorescent lamp etc.), it might cause the remote control transmitter not to work correctly. In this case, reposition the main unit to avoid direct lighting.

For Other Component Control

Identify the remote control transmitter keys with your component's keys. If these keys are identical, their function will be the same. On each key function, refer to the corresponding instruction on your component's manual.

① Tuner keys

Controls tuner

+: Selects higher preset station number.

-: Selects lower preset station number.

A/B/C/D/E Selects the page (A – E) of preset station buttons.

② CD player keys

Controls compact disc player.

* **DISC SKIP** is applicable only to compact disc changer.

③ LD player keys (U.S.A., Canada and General models of CX-2 only)

Controls LD player.

* There are some models which have a key with both the functions of **PLAY** and **PAUSE**.

④ Tape deck keys

Controls tape deck.

* **DIR A, B** and **DECK A/B** are applicable only to double cassette tape deck.

* For a single cassette deck with automatic reverse function, pressing **DIR A** will reverse the direction of tape running.

For Control of This Unit

⑤ POWER

Turns the power on/off.

⑥ Input selector keys

Selects input source.

⑦ MUTING

When pressed, mutes the volume level. To resume original volume level, press this again.

While muting, the indicator above the **VOLUME** control on the front panel illuminates.

⑧ VOLUME +/-

Turns the volume level up/down.

STANDBY mode (For Europe model only)

While the power is on, pressing the **POWER** key on the remote control transmitter switches the unit to the STANDBY mode. (In this mode, the indicator is half illuminated.)

Note

To turn the power off completely, disconnect the AC power plug from the wall outlet.

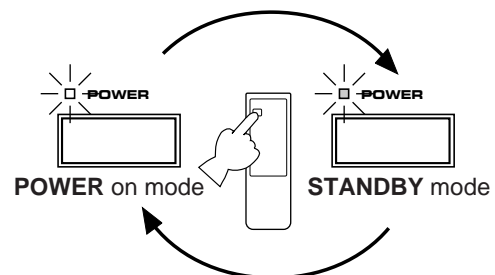

REMOTE CONTROL "LEARNING" FUNCTION (U.S.A., Canada and General models of CX-2 only)

The keys on this remote control transmitter can be programmed to "learn" key-functions from other remote control transmitters without losing the preset key functions. By using this feature, this unit can then be used in place of one or more other remote control transmitters, thus making operation of your various audio and video components more convenient. Use the included user program sheets to indicate a new function learned for each key.

Note

There may occasionally be instances in which, due to the signal-coding and modulation employed by the other remote control transmitter, this unit will not be able to "learn" its signals.

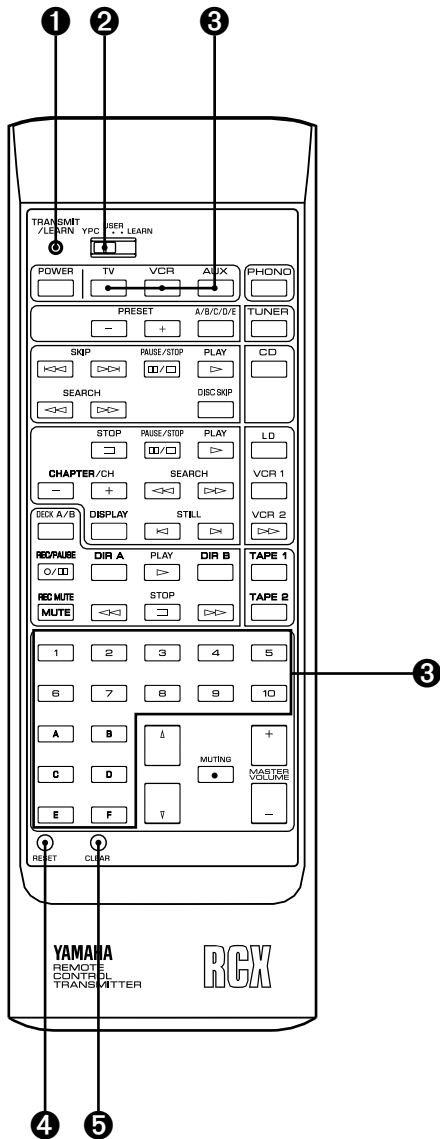

1 TRANSMIT/LEARN indicator

2 YPC-USER-LEARN switch

YPC: Set to this position when using preset key functions (for controlling this unit and/or YAMAHA components).
* "YPC" is the abbreviation of YAMAHA Preset Code.

USER: Set to this position when using "learned" key functions.

LEARN: Set to this position when learning new key functions from other remote control transmitters.

3 Blank keys

These keys have no preset functions and are used only for learning other remote control transmitter's functions.

4 RESET button

Press this button to "reset" the internal microcomputer which controls remote control operations. Microcomputer "reset" is necessary when the remote control freezes.

* Pressing the **RESET** button will not erase learned functions.

5 CLEAR button

This button is used to clear one or all learned key functions. (Refer to page 16.)

To Learn a New Function

1

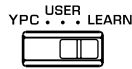

Set to the "LEARN" position.

2 Press a key on this unit where a new function will be learned.

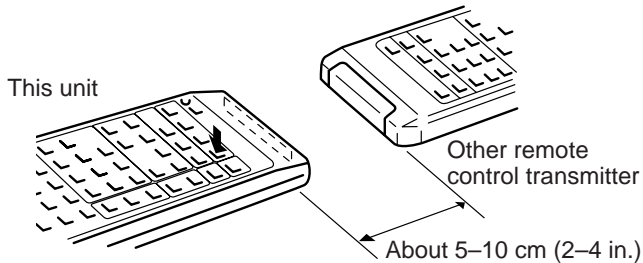

3 Press and hold the key (on the other remote control transmitter) where the desired new function is.

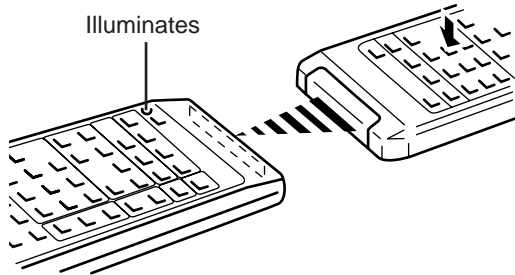

* When the **TRANSMIT/LEARN** indicator stops illuminating, the learning is finished.

4 Repeat step 2 and 3 until all desired functions are successfully learned.

5 Set to the "USER" position.

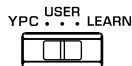

Try operating your components.

Notes

- When you operate the desired component with this remote control transmitter, **TRANSMIT/LEARN** indicator will flash steadily.
- The originally preset function of a key is still available in the **USER** position if a new function has not been learned to the key.
- Successful learning to a key results in the erasure of previously learned functions and their replacement by the newly learned ones.
- If there is no more room in the memory area for a function to be learned, the **TRANSMIT/LEARN** indicator will flash two times. In this case, even if some keys are not occupied with functions from other remote control transmitters, no further learning is possible.

Memory back-up

All of the learned functions will be retained while you replace the batteries. However, if no batteries are installed for a few hours, the learned functions will be erased and will have to be learned again.

Trouble shooting guide

- If learning cannot be made successfully, or if this remote control transmitter does not function even though the learning was successful, check the following points:
 - * Check whether the batteries of the other remote control transmitter are weak.
Note that even though its batteries may be strong enough to operate the component it was made for, they may be too weak to transfer signals to this unit. If so, replace the batteries of the other remote control transmitter.
 - * Check whether the distance between the two remote control transmitters is too long or too short.
- The remote control transmitter's batteries are too weak if the **TRANSMIT/LEARN** indicator does not illuminate or flash, or if the distance or range within which the remote control transmitter can be used decreases.
If either occurs, replace the batteries with new ones.

To Clear a Learned Function

1

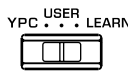

Set to the "USER" position.

2 Press and hold the **CLEAR** button using the point of a mechanical pencil, etc.

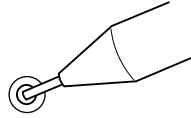

CLEAR

3 Press and hold the key where the learned function to be deleted is until the indicator flashes 3 times.

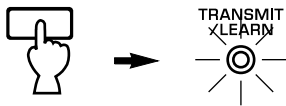

To clear two or more functions, repeat step 2 and 3.

To Clear All Learned Functions

1

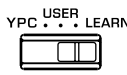

Set to the "LEARN" position.

2 Press and hold the **CLEAR** button using the point of a mechanical pencil, etc.

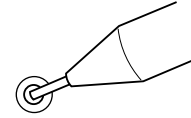

CLEAR

3 Press and hold any key until the indicator flashes 7 times.



Note

If a key is not pressed soon after the **CLEAR** button is pressed, this unit will automatically return to the status that was in effect before the **CLEAR** button was pressed.

SPECIFICATIONS

<CX-1>

Input Sensitivity/Impedance	Headphone Jack Rated Output/Impedance	Residual Noise (IHF-A Network)1.0 μ V
PHONO MM2.5 mV/47 k-ohms	Output Level (100 ohms).....4.5V	Channel Separation (Vol. -30 dB)
PHONO MC	Impedance68 ohms	PHONO MM/MC (Input Shorted)
.....100 μ V/220 ohms, 1 k-ohms	Frequency Response (20 Hz to 20 kHz)	1 kHz/10 kHz)80 dB/70 dB
CD/TUNER/TAPE/AUX	CD/TUNER/TAPE/AUX0 \pm 0.2 dB	CD/TUNER/TAPE/AUX (Input 5.1 k-ohms
.....150 mV/47 k-ohms	RIAA Equalization Deviation (20 Hz to 20 kHz)	Terminated 1 kHz/10 kHz)85 dB/65 dB
Input Sensitivity (New IHF)	PHONO MM \pm 0.2 dB	Tone Control Characteristics
PHONO MM0.83 mV	PHONO MC \pm 0.2 dB	BASS:
PHONO MC33 μ V	Total Harmonic Distortion (20 Hz to 20 kHz)	Boost/cut \pm 10 dB (20 Hz)
CD/TUNER/TAPE/AUX50 mV	PHONO MM to REC OUT (3V)0.002%	Turnover Frequency350 Hz
Maximum Input Signal (1 kHz, 0.05% THD)	PHONO MC to REC OUT (3V)0.003%	TREBLE:
PHONO MM150 mV	CD/TUNER/TAPE/AUX to PRE OUT (3V)	Boost/cut \pm 10 dB (20 kHz)
PHONO MC6 mV0.002%	Turnover Frequency3.5 kHz
Output Level/Impedance	Signal-to-Noise Ratio (IHF-A Network)	Filter Characteristics
REC OUT150 mV/2.5 k-ohms	PHONO MM (5 mV Input Shorted)	SUBSONIC FILTER15 Hz, -18 dB/oct
PRE OUT1.5V/47 ohms95 dB	Audio Muting-20 dB
Maximum Voltage Output	PHONO MC (500 μ V Input Shorted)	Gain Tracking Error (0 to -60 dB)2 dB
(20 Hz to 20 kHz, 1% THD)90 dB	
PRE OUT8V	CD (Input Shorted)110 dB	
	TUNER/TAPE/AUX (Input Shorted)	
107 dB	
	(109 dB for TAPE 3 only)	

Power Supply
 [U.S.A. and Canada models]
AC 120V, 60 Hz
 [Australia and U.K. models]
AC 240V, 50 Hz
 [Europe model]AC 230V, 50 Hz
 [General model]
AC 110/120/220/240V, 50/60 Hz

Power Consumption35W

AC Outlets
 [U.S.A., Canada, Europe and General
 models]
 3 SWITCHED OUTLETS
200W max. total
 [Australia and U.K. models]
 1 SWITCHED OUTLET
200W max. total

Dimensions (W x H x D)
438 x 86 x 405 mm
 (17-1/4" x 3-3/8" x 15-15/16")

Weight8.8 kg (19 lbs. 6 oz.)

AccessoriesRemote control transmitter
 Batteries
 Remote control cable
 Audio connection cord

Specifications subject to change without
 notice.

<CX-2>

Input Sensitivity/Impedance
 PHONO MM2.5 mV/47 k-ohms
 PHONO MC100 μ V/100 ohms
 CD/TUNER/TAPE/VCR/LD
150 mV/47 k-ohms

Input Sensitivity (New IHF)
 PHONO MM0.83 mV
 PHONO MC33 μ V
 CD/TUNER/TAPE/VCR/LD50 mV

Maximum Input Signal (1 kHz, 0.05% THD)
 PHONO MM150 mV
 PHONO MC6 mV

Output Level/Impedance
 REC OUT150 mV/2.5 k-ohms
 PRE OUT1.5V/47 ohms

Maximum Voltage Output
 (20 Hz to 20 kHz, 1% THD)
 PRE OUT8V

Headphone Jack Rated Output/Impedance
 Output Level (150 ohms)4.0V
 Impedance68 ohms

Frequency Response (20 Hz to 20 kHz)
 CD/TUNER/TAPE/VCR/LD0 \pm 0.2 dB

RIAA Equalization Deviation (20 Hz to 20 kHz)
 PHONO MM \pm 0.2 dB
 PHONO MC \pm 0.3 dB

Total Harmonic Distortion (20 Hz to 20 kHz)
 PHONO MM to REC OUT (3V)0.002%
 PHONO MC to REC OUT (3V)0.004%
 CD/TUNER/TAPE/VCR/LD to PRE OUT
 (1.5V)0.002%

Signal-to-Noise Ratio (IHF-A Network)
 PHONO MM (5 mV Input Shorted)
94 dB
 PHONO MC (500 μ V Input Shorted)
82 dB
 CD (Input Shorted)110 dB
 TUNER/TAPE/VCR/LD (Input Shorted)
106 dB

Residual Noise (IHF-A Network)1.0 μ V

Channel Separation (Vol. -30 dB)
 PHONO MM/MC (Input Shorted)
 1 kHz/10 kHz)75 dB/65 dB
 CD/TUNER/TAPE/VCR/LD
 (Input 5.1 k-ohms Terminated 1 kHz/10
 kHz)75 dB/60 dB

Tone Control Characteristics
 BASS:
 Boost/cut \pm 10 dB (20 Hz)
 Turnover Frequency350 Hz
 TREBLE:
 Boost/cut \pm 10 dB (20 kHz)
 Turnover Frequency3.5 kHz

Filter Characteristics
 SUBSONIC FILTER15 Hz, -18 dB/oct
 Continuous Loudness Control
 Attenuation-40 dB (1 kHz)
 (Level related equalization)

Audio Muting-20 dB

Gain Tracking Error (0 to -60 dB)2 dB

Video Input Sensitivity/Impedance
 VCR/LD1 Vp-p/75 Ω

Video Output Level/Impedance
 VCR OUT/MONITOR OUT1 Vp-p/75 Ω

Power Supply
 [U.S.A. and Canada models]
AC 120V, 60 Hz
 [Australia and U.K. models]
AC 240V, 50 Hz
 [Europe model]AC 230V, 50 Hz
 [General model]
AC 110/120/220/240V, 50/60 Hz

Power Consumption30W

AC Outlets
 [U.S.A., Canada, Europe and General
 models]
 3 SWITCHED OUTLETS
200W max. total
 [Australia and U.K. models]
 1 SWITCHED OUTLET
200W max. total

Dimensions (W x H x D)
435 x 86 x 319 mm
 (17-1/8" x 3-3/8" x 15-15/16")

Weight5.4 kg (11 lbs. 14 oz.)

AccessoriesRemote control transmitter
 Batteries
 Remote control cable
 Audio connection cord

Specifications subject to change without
 notice.

TROUBLESHOOTING

If the unit fails to operate normally, check the following points to determine whether the fault can be corrected by the simple measures suggested. If it cannot be corrected, or if the fault is not listed in the SYMPTOM column, disconnect the power cord and contact your authorized YAMAHA dealer or service center for help.

SYMPTOM	CAUSE	REMEDY
The unit fails to turn on when the POWER switch is pressed.	Power cord is not plugged in or is not completely inserted.	Firmly plug in the power cord.
No sound or no picture.	Incorrect output cord connections.	Connect the cords properly. If the problem persists, the cords may be defective.
	Appropriate input source is not selected.	Select an appropriate input source with the INPUT selector.
	Power amp connections are not secure.	Plug in the connection cords properly.
Only one side speaker outputs the sound.	Incorrect setting of the BALANCE control.	Adjust it to the appropriate position.
Sound "hums".	Incorrect cord connections.	Firmly connect the audio plugs. If the problem persists, the cords may be defective.
	No connection from the turntable to the GND terminal.	Make the GND connection between the turntable and this unit.
Sound level is low.	The LOUDNESS control is functioning (for CX-2 only).	Set the LOUDNESS control to the FLAT position.
	The MUTING switch is ON.	First, turn the volume control to the full left. Then, turn the MUTING switch OFF with the remote control transmitter and adjust the volume.
The sound from the MC cartridge is too low	PHONO switch is set to MM.	Set this switch to MC.
Using the BASS, TREBLE, BALANCE and LOUDNESS (for CX-2 only) controls does not affect the tone.	The PURE DIRECT switch is ON.	The PURE DIRECT switch must be switched OFF to use those controls.
The remote control transmitter does not work.	Direct sunlight or lighting (of an inverter type of fluorescent lamp etc.) is striking the remote control sensor of the main unit.	Change position of the main unit.
The distance or range within which the remote control transmitter can be used decreases.	The batteries of this remote control transmitter are too weak.	Replace the batteries with new ones.

YAMAHA

YAMAHA ELECTRONICS CORPORATION, USA 6660 ORANGETHORPE AVE., BUENA PARK, CALIF. 90620, U.S.A.
YAMAHA CANADA MUSIC LTD. 135 MILNER AVE., SCARBOROUGH, ONTARIO M1S 3R1, CANADA
YAMAHA ELECTRONIK EUROPA G.m.b.H. SIEMENSSTR. 22-34, D-2084 RELLINGEN BEI HAMBURG, F.R. OF GERMANY
YAMAHA ELECTRONIQUE FRANCE S.A. 17 RUE DES CAMPANULES, LOGNES 77321 MARNE LA VALLEE CEDEX 2, FRANCE
YAMAHA ELECTRONICS (UK) LTD. YAMAHA HOUSE, 200 RICKMANSWORTH ROAD WATFORD, HERTS WD1 7JS, ENGLAND
YAMAHA SCANDINAVIA A.B. J A WETTERGRENS GATA 1, BOX 30053, 400 43 VÄSTRA FRÖLUNDA, SWEDEN
YAMAHA MUSIC AUSTRALIA PTY, LTD. 17-33 MARKET ST., SOUTH MELBOURNE, 3205 VIC., AUSTRALIA

YAMAHA CORPORATION
VQ12700-0 BWWO,O Printed in Japan